

<b>Pictorial index</b>	Search by illustration	
<b>For safety and security</b>	Make sure to read through them (Main topics: Child seat, theft deterrent system)	1
<b>Vehicle status information and indicators</b>	Reading driving-related information (Main topics: Meters, multi-information display)	2
<b>Before driving</b>	Opening and closing the doors and windows, adjustment before driving (Main topics: Keys, doors, seats)	3
<b>Driving</b>	Operations and advice which are necessary for driving (Main topics: Starting engine, refueling)	4
<b>Audio</b>	Operating the Audio (Main topics: Audio/visual, phone, Connected Services)	5
<b>Interior features</b>	Usage of the interior features (Main topics: Air conditioner, storage features)	6
<b>Maintenance and care</b>	Caring for your vehicle and maintenance procedures (Main topics: Interior and exterior, light bulbs)	7
<b>When trouble arises</b>	What to do in case of malfunction and emergency (Main topics: Battery discharge, flat tire)	8
<b>Vehicle specifications</b>	Vehicle specifications, customizable features (Main topics: Fuel, oil, tire inflation pressure)	9
<b>For owners</b>	Reporting safety defects for U.S. owners, and seat belt and SRS airbag instructions for Canadian owners	10
<b>Index</b>	Search by symptom	
	Search alphabetically	

For your information.....	8
Reading this manual.....	12
How to search.....	13
Pictorial index.....	14

## 1 For safety and security

<b>1-1. For safe use</b>	
Before driving.....	26
For safe driving.....	27
Seat belts.....	29
SRS airbags.....	33
Front passenger occupant classification system.....	43
Exhaust gas precautions..	48
<b>1-2. Child safety</b>	
Riding with children.....	49
Child restraint systems.....	50
<b>1-3. Emergency assistance</b>	
Safety Connect.....	65
<b>1-4. Theft deterrent system</b>	
Engine immobilizer system.....	70
Alarm.....	73

## 2 Vehicle status information and indicators

<b>2-1. Instrument cluster</b>	
Warning lights and indicators.....	76
Gauges and meters (with 4.2-inch display).....	82
Gauges and meters (with 7-inch display).....	85
Multi-information display ..	89

Fuel consumption information.....	99
-----------------------------------	----

## 3 Before driving

<b>3-1. Key information</b>	
Keys.....	102
<b>3-2. Opening, closing and locking the doors</b>	
Side doors.....	108
Back door.....	114
Smart key system.....	128
<b>3-3. Adjusting the seats</b>	
Front seats.....	134
Rear seats.....	135
Driving position memory.....	137
Head restraints.....	140
<b>3-4. Adjusting the steering wheel and mirrors</b>	
Steering wheel.....	142
Inside rear view mirror... ..	143
Digital Rear-view Mirror.....	145
Outside rear view mirrors.....	154
<b>3-5. Opening, closing the windows and moon roof</b>	
Power windows.....	156
Moon roof.....	159
Panoramic moon roof....	162

## 4 Driving

<b>4-1. Before driving</b>	
Driving the vehicle.....	169
Cargo and luggage.....	175
Vehicle load limits.....	178

Trailer towing.....	179	
Dinghy towing .....	191	
<b>4-2. Driving procedures</b>		
Engine (ignition) switch (vehicles without smart key system).....	193	
Engine (ignition) switch (vehicles with smart key system) .....	194	
Automatic transmission.	199	
Turn signal lever.....	202	
Parking brake .....	203	
Brake Hold .....	206	
<b>4-3. Operating the lights and wipers</b>		
Headlight switch.....	209	
AHB (Automatic High Beam) .....	212	
Fog light switch .....	215	
Windshield wipers and washer.....	215	
Rear window wiper and washer.....	218	
<b>4-4. Refueling</b>		
Opening the fuel tank cap .....	220	
<b>4-5. Using the driving support systems</b>		
Toyota Safety Sense 2.0	223	
PCS (Pre-Collision System) .....	229	
LTA (Lane Tracing Assist) .....	237	
RSA (Road Sign Assist)	247	
Dynamic radar cruise control with full-speed range ...	250	
BSM (Blind Spot Monitor) .....	260	
Intuitive parking assist...	270	
PKSB (Parking Support Brake).....	277	
Parking Support Brake function (static objects) .....	282	1
Parking Support Brake function (rear-crossing vehicles) .....	288	2
Rear view monitor system .....	292	
Toyota parking assist monitor .....	300	3
Panoramic view monitor	313	4
Stop & Start system.....	345	
Driving mode select switch .....	351	5
Multi-terrain Select (AWD vehicles) .....	353	6
Snow mode switch (AWD vehicles) .....	357	
Downhill assist control system .....	358	7
Driving assist systems...	360	
<b>4-6. Driving tips</b>		8
Winter driving tips.....	367	
Utility vehicle precautions .....	370	9
<b>5 Audio</b>		10
<b>5-1. Basic function</b>		
Buttons overview .....	375	
Menu screen.....	377	
Status icon.....	378	
“Setup” screen.....	380	

---

<b>5-2. Basic information before operation</b>	
Initial screen.....	381
Touch screen.....	382
Home screen.....	384
Entering letters and numbers/list screen operation .....	385
Screen adjustment.....	388
Linking multi-information display and the system ....	389
<b>5-3. Connectivity settings</b>	
Registering/Connecting a Bluetooth® device .....	390
Setting Bluetooth® details .....	394
Wi-Fi® Hotspot .....	402
<b>5-4. Apple CarPlay/Android Auto</b>	
Apple CarPlay®/Android Auto .....	407
<b>5-5. Other settings</b>	
General settings.....	414
Voice settings.....	418
Vehicle settings .....	419
<b>5-6. Using the audio/visual system</b>	
Quick reference.....	420
Some basics .....	421
<b>5-7. Radio operation</b>	
AM/FM/SiriusXM (SXM) radio .....	425
<b>5-8. Media operation</b>	
USB memory.....	432
iPod/iPhone (Apple CarPlay).....	434
Android Auto.....	437
Bluetooth® audio .....	438
<b>5-9. Audio/visual remote controls</b>	
Steering switches .....	442
<b>5-10. Audio settings</b>	
Setup.....	444
<b>5-11. Tips for operating the audio/visual system</b>	
Operating information....	446
<b>5-12. Voice command system operation</b>	
Voice command system	458
Command list .....	461
<b>5-13. Phone operation (Hands-free system for cellular phones)</b>	
Quick reference.....	465
Some basics.....	466
Placing a call using the Bluetooth® hands-free system .....	470
Receiving a call using the Bluetooth® hands-free system .....	473
Talking on the Bluetooth® hands-free system.....	474
Bluetooth® phone message function.....	476
<b>5-14. Phone settings</b>	
Setup .....	481
<b>5-15. What to do if... (Bluetooth®)</b>	
Troubleshooting.....	491

**5-16.Connected Services overview**

- Connected Services ..... 495
- Type A: Function achieved by using a smartphone or DCM ..... 496
- Type B: Function achieved by using DCM and the system ..... 498
- Type C: Function achieved by using DCM ..... 499
- Type D: Function achieved by using DCM and a smartphone ..... 502

**5-17.Connected Services operation**

- Toyota Apps ..... 504

**5-18.Setup**

- Toyota Apps settings ..... 508

**6 Interior features**

**6-1. Using the air conditioning system and defogger**

- Manual air conditioning system ..... 510
- Automatic air conditioning system..... 515
- Heated steering wheel/seat heaters/seat ventilators 522

**6-2. Using the interior lights**

- Interior lights list ..... 525

**6-3. Using the storage features**

- List of storage features . 528
- Luggage compartment features ..... 532

**6-4. Using the other interior features**

- Other interior features ... 537
- Garage door opener ..... 548

**7 Maintenance and care**

**7-1. Maintenance and care**

- Cleaning and protecting the vehicle exterior ..... 558
- Cleaning and protecting the vehicle interior ..... 561

**7-2. Maintenance**

- Maintenance requirements ..... 564
- General maintenance .... 565
- Emission inspection and maintenance (I/M) programs ..... 568

**7-3. Do-it-yourself maintenance**

- Do-it-yourself service precautions ..... 569
- Hood ..... 571
- Positioning a floor jack .. 572
- Engine compartment .... 574
- Tires ..... 581
- Tire inflation pressure .... 595
- Wheels ..... 597
- Air conditioning filter ..... 599
- Wiper insert replacement ..... 601
- Wireless remote control/electronic key battery ..... 604
- Checking and replacing fuses ..... 607
- Light bulbs ..... 609



**8 When trouble arises****8-1. Essential information**

Emergency flashers ..... 618

If your vehicle has to be  
stopped in an emergency  
..... 618If the vehicle is trapped in ris-  
ing water..... 619**8-2. Steps to take in an emer-  
gency**If your vehicle needs to be  
towed..... 621If you think something is  
wrong ..... 626Fuel pump shut off system  
..... 627If a warning light turns on or a  
warning buzzer sounds 628If a warning message is dis-  
played..... 639

If you have a flat tire..... 642

If the engine will not start 651

If you lose your keys ..... 653

If the electronic key does not  
operate properly (vehicles  
with smart key system) 653If the vehicle battery is dis-  
charged ..... 655

If your vehicle overheats 659

If the vehicle becomes stuck  
..... 661**9 Vehicle specifications****9-1. Specifications**Maintenance data (fuel, oil  
level, etc.)..... 664

Fuel information..... 676

Tire information ..... 678

**9-2. Customization**

Customizable features... 688

**9-3. Initialization**

Items to initialize..... 699

**10 For owners****10-1. For owners**Reporting safety defects for  
U.S. owners..... 702Seat belt instructions for  
Canadian owners (in  
French) ..... 703SRS airbag instructions for  
Canadian owners (in  
French) ..... 704**Index**What to do if... (Troubleshoot-  
ing) ..... 714

Alphabetical Index ..... 717

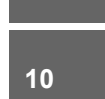
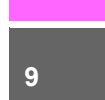

## For your information

### Main Owner's Manual

Please note that this manual applies to all models and explains all equipment, including options. Therefore, you may find some explanations for equipment not installed on your vehicle.

All specifications provided in this manual are current at the time of printing. However, because of the Toyota policy of continual product improvement, we reserve the right to make changes at any time without notice.

Depending on specifications, the vehicle shown in the illustrations may differ from your vehicle in terms of equipment.

### Noise from under vehicle after turning off the engine

Approximately five hours after the engine is turned off, you may hear sound coming from under the vehicle for several minutes. This is the sound of a fuel evaporation leakage check and, it does not indicate a malfunction.

### Accessories, spare parts and modification of your Toyota

A wide variety of non-genuine spare parts and accessories for Toyota vehicles are currently available in the market. You should know that Toyota does not warrant these products and is not responsible for their performance, repair, or replacement, or for any damage they may cause to, or adverse effect they may have on, your Toyota vehicle.

This vehicle should not be modified with non-genuine Toyota products. Modification with non-genuine Toyota products could affect its performance, safety or durability, and may even violate governmental regulations. In addition, damage or performance problems resulting from the modification may not be covered under warranty.

### Installation of a mobile two-way radio system

The installation of a mobile two-way radio system in your vehicle could affect electronic systems such as:

- Multiport fuel injection system/sequential multiport fuel injection system
- Toyota Safety Sense 2.0



- Anti-lock brake system
- SRS airbag system
- Seat belt pretensioner system

Be sure to check with your Toyota dealer for precautionary measures or special instructions regarding installation of a mobile two-way radio system.

### Vehicle data recording

The vehicle is equipped with sophisticated computers that will record certain data, such as:

- Engine speed/ Electric motor speed (traction motor speed)
- Accelerator status
- Brake status
- Vehicle speed
- Operation status of the driving assist systems
- Images from the front camera (available only when certain safety systems are activated, which varies depending on the vehicle specifications).

The recorded data varies according to the vehicle grade level and options with which it is equipped.

These computers do not record conversations or sounds, and only record images outside of the vehicle in certain situations.

#### ● Data Transmission

Your vehicle may transmit the data recorded in these computers to Toyota without notification to you.

#### ● Data usage

Toyota may use the data recorded in this computer to diagnose malfunctions, conduct research and development, and improve quality.

Toyota will not disclose the recorded data to a third party except:

- With the consent of the vehicle owner or with the consent of the lessee if the vehicle is leased
- In response to an official request by the police, a court of law or a government agency
- For use by Toyota in a lawsuit
- For research purposes where the data is not tied to a specific vehicle or vehicle owner
- Recorded image information can be erased by your Toyota dealer.

The image recording function can be disabled. However, if the function is disabled, data from when the system operates will not be available.

- To learn more about the vehicle data collected, used and shared by Toyota, please visit [www.toyota.com/privacyvts/](http://www.toyota.com/privacyvts/).

### Usage of data collected through Safety Connect (U.S. mainland only)

If your Toyota has Safety Connect and if you have subscribed to those services, please refer to the Safety Connect Telematics Subscription Service Agreement

for information on data collected and its usage.

- To learn more about the vehicle data collected, used and shared by Toyota, please visit [www.toyota.com/privacyvts/](http://www.toyota.com/privacyvts/).

### Event data recorder

This vehicle is equipped with an event data recorder (EDR). The main purpose of an EDR is to record, in certain crash or near crash-like situations, such as an air bag deployment or hitting a road obstacle, data that will assist in understanding how a vehicle's systems performed. The EDR is designed to record data related to vehicle dynamics and safety systems for a short period of time, typically 30 seconds or less.

The EDR in this vehicle is designed to record such data as:

- How various systems in your vehicle were operating;
- Whether or not the driver and passenger safety belts were buckled/fastened;
- How far (if at all) the driver was depressing the accelerator and/or brake pedal; and,
- How fast the vehicle was traveling.

These data can help provide a better understanding of the cir-

cumstances in which crashes and injuries occur.

NOTE: EDR data are recorded by your vehicle only if a non-trivial crash situation occurs; no data are recorded by the EDR under normal driving conditions and no personal data (e.g., name, gender, age, and crash location) are recorded. However, other parties, such as law enforcement, could combine the EDR data with the type of personally identifying data routinely acquired during a crash investigation.

To read data recorded by an EDR, special equipment is required, and access to the vehicle or the EDR is needed. In addition to the vehicle manufacturer, other parties, such as law enforcement, that have the special equipment, can read the information if they have access to the vehicle or the EDR.

#### ● Disclosure of the EDR data

Toyota will not disclose the data recorded in an EDR to a third party except when:

- An agreement from the vehicle's owner (or the lessee for a leased vehicle) is obtained
- In response to an official request by the police, a court of law or a government agency
- For use by Toyota in a lawsuit

However, if necessary, Toyota may:

- Use the data for research on

vehicle safety performance

- Disclose the data to a third party for research purposes without disclosing information about the specific vehicle or vehicle owner

### Scrapping of your Toyota

The SRS airbag and seat belt pretensioner devices in your Toyota contain explosive chemicals. If the vehicle is scrapped with the airbags and seat belt pretensioners left as they are, this may cause an accident such as fire. Be sure to have the systems of the SRS airbag and seat belt pretensioner removed and disposed of by a qualified service shop or by your Toyota dealer before you scrap your vehicle.

### Perchlorate Material

Special handling may apply, See [www.dtsc.ca.gov/hazardouswaste/perchlorate](http://www.dtsc.ca.gov/hazardouswaste/perchlorate).

Your vehicle has components that may contain perchlorate. These components may include the airbags, seat belt pretensioners, wireless remote control batteries, and the batteries in the tire pressure warning valve and transmitters.

### WARNING

#### ■ General precautions while driving

**Driving under the influence:** Never drive your vehicle when under the influence of alcohol or drugs that have impaired your ability to operate your vehicle. Alcohol and certain drugs delay reaction time, impair judgment and reduce coordination, which could lead to an accident that could result in death or serious injury.

**Defensive driving:** Always drive defensively. Anticipate mistakes that other drivers or pedestrians might make and be ready to avoid accidents.

**Driver distraction:** Always give your full attention to driving. Anything that distracts the driver, such as adjusting controls, talking on a cellular phone or reading can result in a collision with resulting death or serious injury to you, your occupants or others.

#### ■ General precaution regarding children's safety



Never leave children unattended in the vehicle, and never allow children to have or use the key.

Children may be able to start the vehicle or shift the vehicle into neutral. There is also a danger that children may injure themselves by playing with the side windows, the moon roof or the panoramic moon roof, or other features of the vehicle. In addition, heat build-up or extremely cold temperatures inside the vehicle can be fatal to children.

**Reading this manual**



**Explains symbols used in this manual**

**Symbols in this manual**

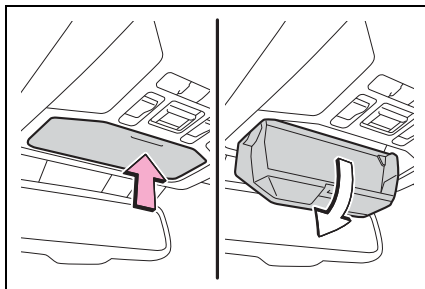

Symbols	Meanings
	<b>WARNING:</b> Explains something that, if not obeyed, could cause death or serious injury to people.
	<b>NOTICE:</b> Explains something that, if not obeyed, could cause damage to or a malfunction in the vehicle or its equipment.
1 2 3...	Indicates operating or working procedures. Follow the steps in numerical order.

**Symbols in illustrations**

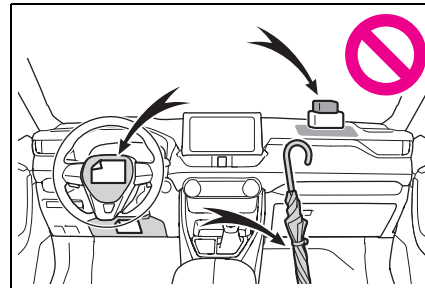

Symbols	Meanings
	Indicates the action (pushing, turning, etc.) used to operate switches and other devices.
	Indicates the outcome of an operation (e.g. a lid opens).



Symbols	Meanings
	Indicates the component or position being explained.
	Means <b>Do not</b> , <b>Do not do this</b> , or <b>Do not let this happen</b> .

## How to search

### ■ Searching by name

- Alphabetical index: →P.717

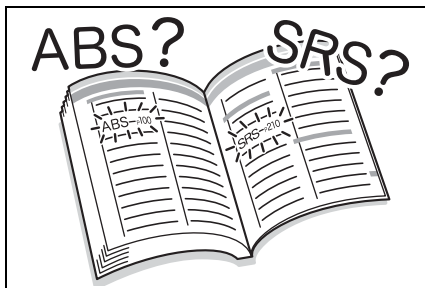

### ■ Searching by installation position

- Pictorial index: →P.14

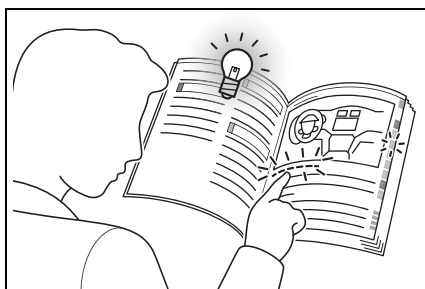

### ■ Searching by symptom or sound

- What to do if... (Troubleshooting): →P.714



### ■ Searching by title

- Table of contents: →P.2

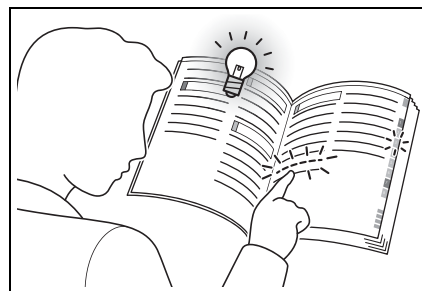

## Pictorial index

### ■ Exterior

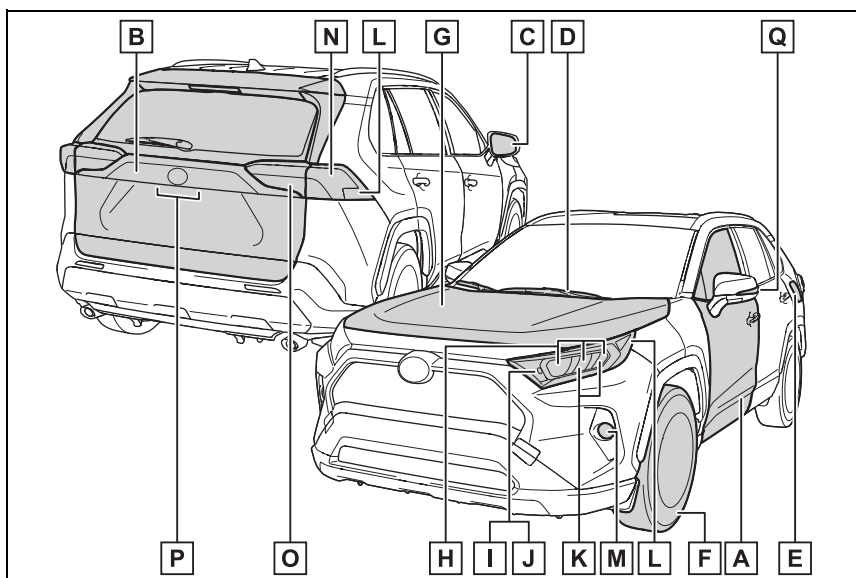

- A Side doors ..... P.108**
  - Locking/unlocking ..... P.108
  - Opening/closing the side windows ..... P.156
  - Locking/unlocking by using the key ..... P.109, 653
  - Warning messages ..... P.639
- B Back door ..... P.114**
  - Locking/unlocking ..... P.115
  - Opening from inside the cabin\* ..... P.118
  - Opening from outside ..... P.116, 118
  - Warning messages ..... P.639
- C Outside rear view mirrors ..... P.154**
  - Adjusting the mirror angle ..... P.154
  - Folding the mirrors ..... P.154
  - Defogging the mirrors\* ..... P.511, 517
- D Windshield wipers ..... P.215**

Precautions against winter season .....	P.367
To prevent freezing (windshield wiper de-icer)* .....	P.520
Precautions against car wash (Rain-sensing windshield wipers)* .....	P.559
Replacing the wiper insert.....	P.601
<b>E Fuel filler door .....</b>	<b>P.220</b>
Refueling method .....	P.220
Fuel type/fuel tank capacity .....	P.666
<b>F Tires.....</b>	<b>P.581</b>
Tire size/inflation pressure .....	P.671
Winter tires/tire chain .....	P.367
Checking/rotation/tire pressure warning system * .....	P.581
Coping with flat tires.....	P.642
<b>G Hood.....</b>	<b>P.571</b>
Opening .....	P.571
Engine oil .....	P.666
Coping with overheat .....	P.659
Warning messages .....	P.639

### Light bulbs of the exterior lights for driving

(Replacing method: P.609, Watts: P.675)

<b>H Headlights.....</b>	<b>P.209</b>
<b>I Turn signal lights .....</b>	<b>P.202</b>
<b>J Parking lights .....</b>	<b>P.209</b>
<b>K Daytime running lights .....</b>	<b>P.209</b>
<b>L Side marker lights .....</b>	<b>P.209</b>
<b>M Fog lights* .....</b>	<b>P.437</b>
<b>N Stop lights/tail lights/turn signal lights.....</b>	<b>P.202, 209</b>
<b>O Tail lights.....</b>	<b>P.209</b>
<b>Back-up lights</b>	

Shifting the shift lever to R..... P.199

**P** License plate lights..... **P.209**

**Q** Side turn signal lights\* ..... **P.202**

\*: If equipped



## ■ Instrument panel

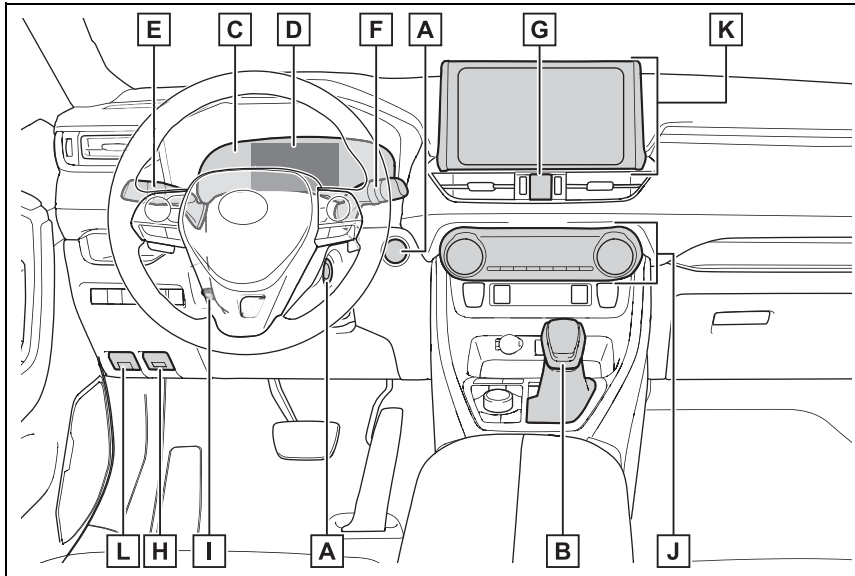

- A Engine switch** ..... P.193, 194  
 Starting the engine/changing the modes ..... P.193, 194, 197  
 Emergency stop of the engine ..... P.618  
 When the engine will not start ..... P.651  
 Warning messages ..... P.639
- B Shift lever** ..... P.199  
 Changing the shift position ..... P.200  
 Precautions against towing ..... P.621  
 When the shift lever does not move ..... P.200
- C Meters** ..... P.82, 85  
 Reading the meters/adjusting the instrument panel  
 light ..... P.82, 84, 85, 88  
 Warning lights/indicator lights ..... P.76  
 When the warning lights come on ..... P.628
- D Multi-information display** ..... P.89  
 Display ..... P.89

When the warning messages are displayed ..... P.639

**E Turn signal lever..... P.202**  
**Headlight switch ..... P.209**  
 Headlights/parking lights/tail lights/  
 license plate lights/daytime running lights..... P.209  
 Fog lights \*1 ..... P.437

**F Windshield wiper and washer switch..... P.215**  
**Rear window wiper and washer switch ..... P.218**  
 Usage..... P.215, 218  
 Adding washer fluid..... P.580  
 Warning messages ..... P.639

**G Emergency flasher switch..... P.618**

**H Hood lock release lever ..... P.571**

**I Tilt and telescopic steering lock release lever ..... P.142**  
 Adjustment ..... P.142

**J Air conditioning system ..... P.510, 515**  
 Usage..... P.510, 515  
 Rear window defogger ..... P.511, 517

**K Audio\*1 ..... P.375**  
**Audio Plus\*1, 2**  
**Premium Audio \*1, 2**

**L Fuel filler door opener lever..... P.221**

\*1: If equipped

\*2: Refer to “NAVIGATION AND MULTIMEDIA SYSTEM OWNER’S MANUAL”.

■ Switches

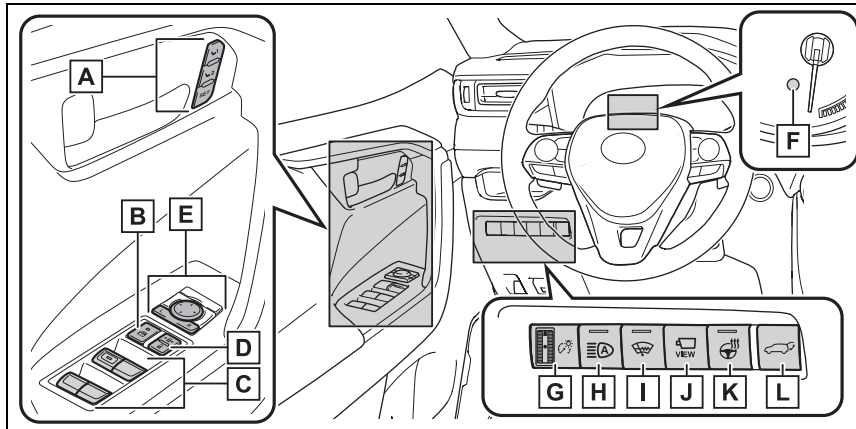

- A** Driving position memory switches \* ..... P.137
- B** Window lock switch ..... P.158
- C** Power window switches ..... P.156
- D** Door lock switches ..... P.112
- E** Outside rear view mirror switches ..... P.154
- F** “ODO TRIP” switch ..... P.84, 88
- G** Instrument panel light control dial ..... P.84, 88
- H** Automatic High Beam switch ..... P.212
- I** Windshield wiper de-icer switch \* ..... P.520
- J** Camera switch \* ..... P.315
- K** Heated steering wheel switch \* ..... P.522
- L** Power back door switch \* ..... P.118

\* : If equipped

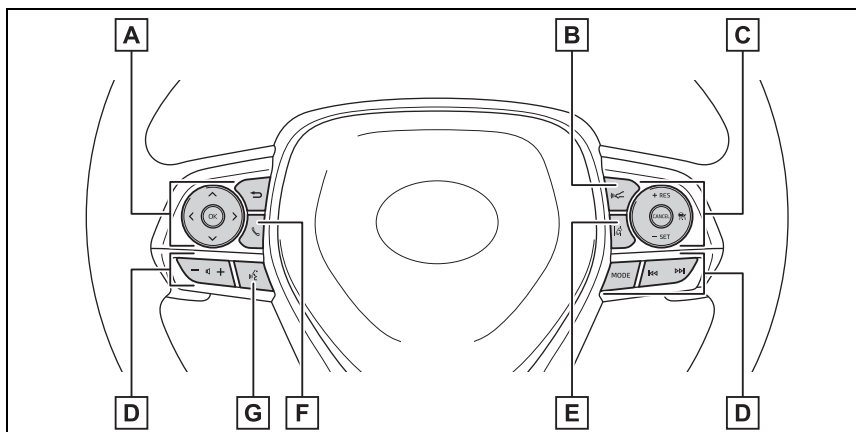

- A** Meter control switches ..... P.90
- B** Vehicle-to-vehicle distance switch ..... P.255
- C** Cruise control switches
  - Dynamic radar cruise control with full-speed range ..... P.250
- D** Audio remote control switches \* ..... P.442
- E** LTA (Lane Tracing Assist) switch ..... P.237
- F** Phone switch \* ..... P.468
- G** Talk switch \* ..... P.458

\*: Vehicles with Audio Plus or Premium Audio, refer to "NAVIGATION AND MULTIMEDIA SYSTEM OWNER'S MANUAL".

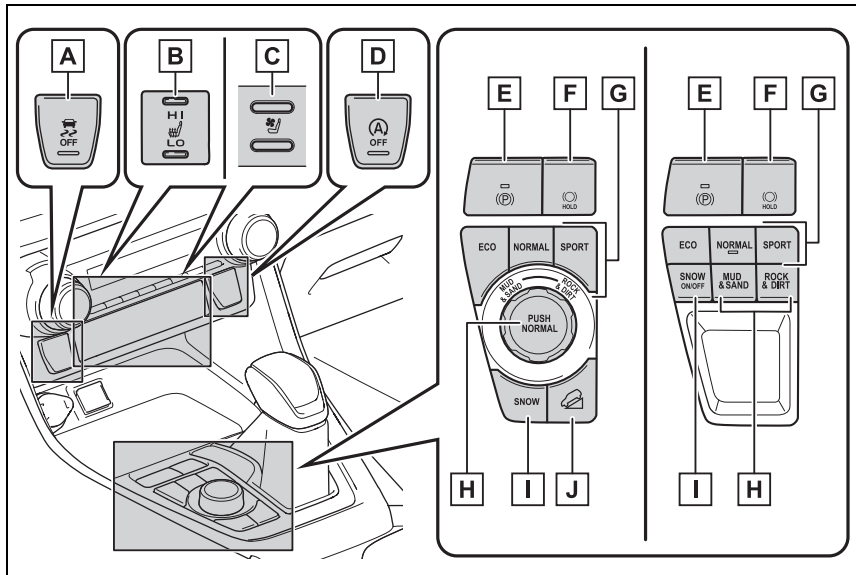

- A** VSC OFF switch ..... P.361
- B** Front seat heater switches\* ..... P.522
- C** Front seat heater/ventilator switches\* ..... P.523
- D** Stop & Start cancel switch\* ..... P.346
- E** Parking brake switch ..... P.203
  - Applying/releasing ..... P.203
  - Precautions against winter season ..... P.368
  - Warning buzzer/message ..... P.634, 639
- F** Brake hold switch ..... P.206
- G** Driving mode select switch ..... P.351
- H** Multi-terrain Select switch\* ..... P.353
- I** SNOW mode switch\* ..... P.357
- J** “DAC” switch\* ..... P.358

\*: If equipped

■ Interior

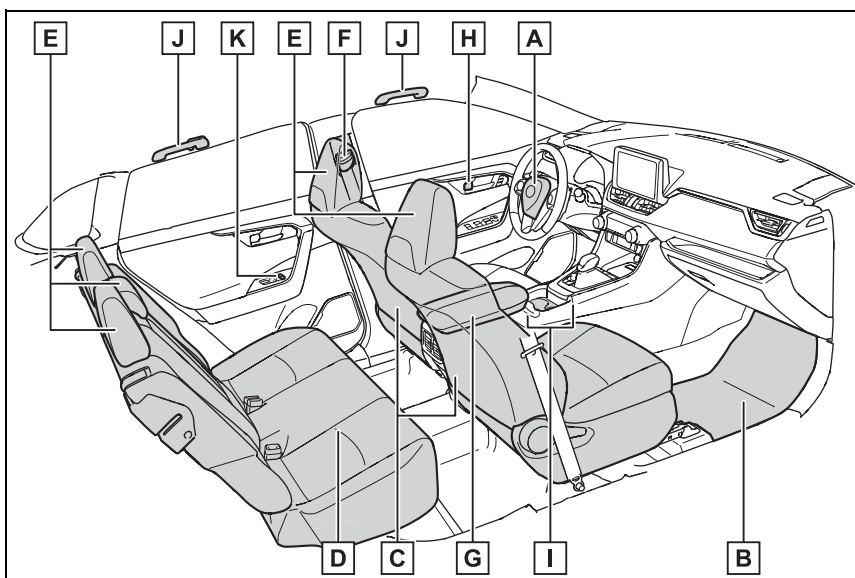

<b>A</b>	<b>SRS airbags</b> .....	<b>P.33</b>
<b>B</b>	<b>Floor mats</b> .....	<b>P.26</b>
<b>C</b>	<b>Front seats</b> .....	<b>P.134</b>
<b>D</b>	<b>Rear seats</b> .....	<b>P.135</b>
<b>E</b>	<b>Head restraints</b> .....	<b>P.140</b>
<b>F</b>	<b>Seat belts</b> .....	<b>P.29</b>
<b>G</b>	<b>Console box</b> .....	<b>P.529</b>
<b>H</b>	<b>Inside lock buttons</b> .....	<b>P.112</b>
<b>I</b>	<b>Cup holders</b> .....	<b>P.529</b>
<b>J</b>	<b>Assist grips</b> .....	<b>P.547</b>
<b>K</b>	<b>Rear seat heater switches</b> .....	<b>P.522</b>

\*: If equipped

■ Ceiling

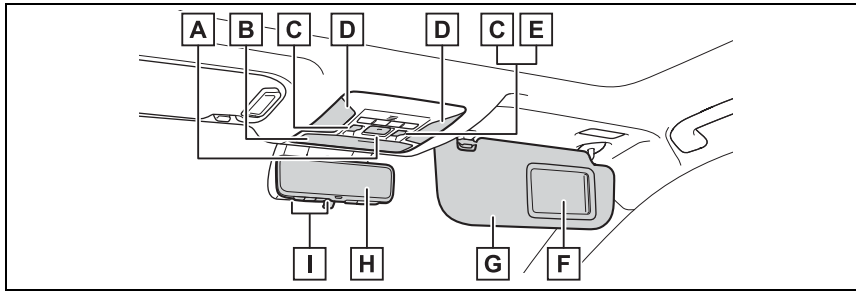

<b>A</b>	“SOS” button <sup>*1</sup> .....	P.65
<b>B</b>	Auxiliary box .....	P.530
<b>C</b>	Moon roof switches <sup>*1</sup> .....	P.159
<b>D</b>	Interior lights <sup>*2</sup> .....	P.525
	Personal lights .....	P.526
<b>E</b>	Electronic sunshade switch <sup>*1</sup> .....	P.162
<b>F</b>	Vanity mirrors .....	P.537
<b>G</b>	Sun visors .....	P.537
<b>H</b>	Inside rear view mirror <sup>*1</sup> .....	P.143
	Digital Rear-view Mirror <sup>*1</sup> .....	P.145
<b>I</b>	Garage door opener switches <sup>*1</sup> .....	P.548

<sup>\*1</sup>: If equipped

<sup>\*2</sup>: The illustration shows the front, but they are also equipped in the rear.





**For safety and security**

1

25

**1-1. For safe use**

- Before driving ..... 26
- For safe driving ..... 27
- Seat belts ..... 29
- SRS airbags ..... 33
- Front passenger occupant classification system .... 43
- Exhaust gas precautions 48

**1-2. Child safety**

- Riding with children ..... 49
- Child restraint systems... 50

**1-3. Emergency assistance**

- Safety Connect ..... 65

**1-4. Theft deterrent system**

- Engine immobilizer system ..... 70
- Alarm..... 73

1

For safety and security

### Before driving

**Observe the following before starting off in the vehicle to ensure safety of driving.**

### Installing floor mats

Use only floor mats designed specifically for vehicles of the same model and model year as your vehicle. Fix them securely in place onto the carpet.

- 1 Insert the retaining hooks (clips) into the floor mat eye-lets.

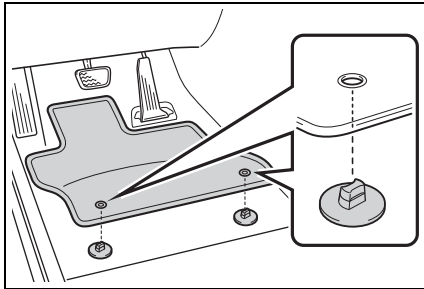

- 2 Turn the upper knob of each retaining hook (clip) to secure the floor mats in place.

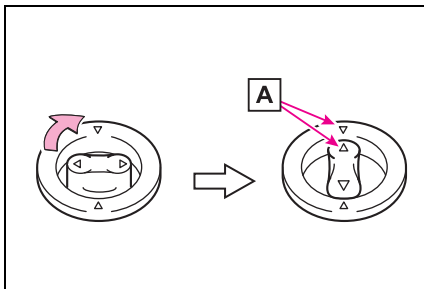

Always align the  $\triangle$  marks **A**.

The shape of the retaining hooks (clips) may differ from that shown in the illustration.

### **WARNING**

Observe the following precautions. Failure to do so may cause the driver's floor mat to slip, possibly interfering with the pedals while driving. An unexpectedly high speed may result or it may become difficult to stop the vehicle. This could lead to an accident, resulting in death or serious injury.

#### ■ When installing the driver's floor mat

- Do not use floor mats designed for other models or different model year vehicles, even if they are Toyota Genuine floor mats.
- Only use floor mats designed for the driver's seat.
- Always install the floor mat securely using the retaining hooks (clips) provided.
- Do not use two or more floor mats on top of each other.
- Do not place the floor mat bottom-side up or upside-down.

**⚠ WARNING****■ Before driving**

- Check that the floor mat is securely fixed in the correct place with all the provided retaining hooks (clips). Be especially careful to perform this check after cleaning the floor.

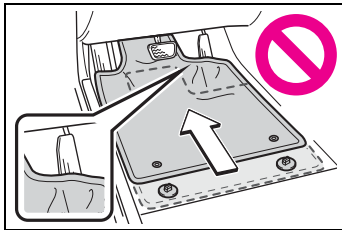

- With the engine stopped and the shift lever in P, fully depress each pedal to the floor to make sure it does not interfere with the floor mat.

**For safe driving**

**For safe driving, adjust the seat and mirror to an appropriate position before driving.**

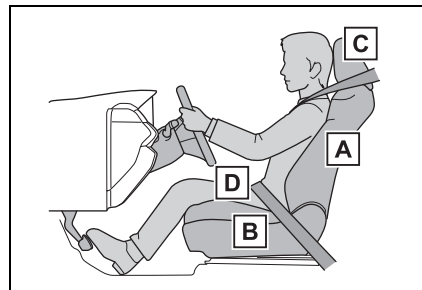
**Correct driving posture**

- A** Adjust the angle of the seat-back so that you are sitting straight up and so that you do not have to lean forward to steer. (→P.134)
- B** Adjust the seat so that you can depress the pedals fully and so that your arms bend slightly at the elbow when gripping the steering wheel. (→P.134)
- C** Lock the head restraint in place with the center of the head restraint closest to the top of your ears. (→P.140)
- D** Wear the seat belt correctly. (→P.30)

**⚠ WARNING**

Observe the following precautions.

Failure to do so may result in death or serious injury.

- Do not adjust the position of the driver's seat while driving. Doing so could cause the driver to lose control of the vehicle.
- Do not place a cushion between the driver or passenger and the seatback. A cushion may prevent correct posture from being achieved, and reduce the effectiveness of the seat belt and head restraint.
- Do not place anything under the front seats. Objects placed under the front seats may become jammed in the seat tracks and stop the seat from locking in place. This may lead to an accident and the adjustment mechanism may also be damaged.
- Always observe the legal speed limit when driving on public roads.
- When driving over long distances, take regular breaks before you start to feel tired. Also, if you feel tired or sleepy while driving, do not force yourself to continue driving and take a break immediately.

**Correct use of the seat belts**

Make sure that all occupants are wearing their seat belts before driving the vehicle. (→P.30)

Use a child restraint system appropriate for the child until the child becomes large enough to

properly wear the vehicle's seat belt. (→P.50)

**Adjusting the mirrors**

Make sure that you can see backward clearly by adjusting the inside rear view mirror (if equipped), Digital Rear-view Mirror (if equipped) and outside rear view mirrors properly. (→P.143, 145, 154)

## Seat belts

**Make sure that all occupants are wearing their seat belts before driving the vehicle.**

### WARNING

Observe the following precautions to reduce the risk of injury in the event of sudden braking, sudden swerving or an accident. Failure to do so may cause death or serious injury.

#### ■ Wearing a seat belt

- Ensure that all passengers wear a seat belt.
- Always wear a seat belt properly.
- Each seat belt should be used by one person only. Do not use a seat belt for more than one person at once, including children.
- Toyota recommends that children be seated in the rear seat and always use a seat belt and/or an appropriate child restraint system.
- To achieve a proper seating position, do not recline the seat more than necessary. The seat belt is most effective when the occupants are sitting up straight and well back in the seats.
- Do not wear the shoulder belt under your arm.
- Always wear your seat belt low and snug across your hips.

#### ■ Pregnant women

Obtain medical advice and wear the seat belt in the proper way. (→P.30)

Women who are pregnant should position the lap belt as low as possible over the hips in the same manner as other occupants, extending the shoulder belt completely over the shoulder and avoiding belt contact with the rounding of the abdominal area.

If the seat belt is not worn properly, not only the pregnant woman, but also the fetus could suffer death or serious injury as a result of sudden braking or a collision.

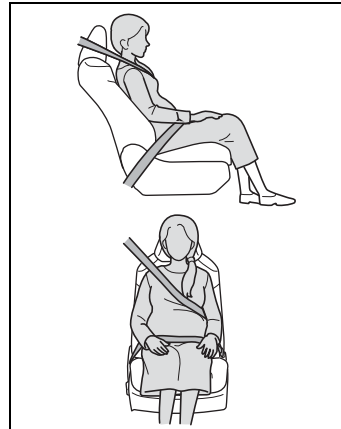

#### ■ People suffering illness

Obtain medical advice and wear the seat belt in the proper way. (→P.30)

#### ■ When children are in the vehicle

→P.58

#### ■ Seat belt damage and wear

- Do not damage the seat belts by allowing the belt, plate, or buckle to be jammed in the door.

**⚠ WARNING**

- Inspect the seat belt system periodically. Check for cuts, fraying, and loose parts. Do not use a damaged seat belt until it is replaced. Damaged seat belts cannot protect an occupant from death or serious injury.
- Ensure that the belt and plate are locked and the belt is not twisted.  
If the seat belt does not function correctly, immediately contact your Toyota dealer.
- Replace the seat assembly, including the belts, if your vehicle has been involved in a serious accident, even if there is no obvious damage.
- Do not attempt to install, remove, modify, disassemble or dispose of the seat belts. Have any necessary repairs carried out by your Toyota dealer. Inappropriate handling may lead to incorrect operation.

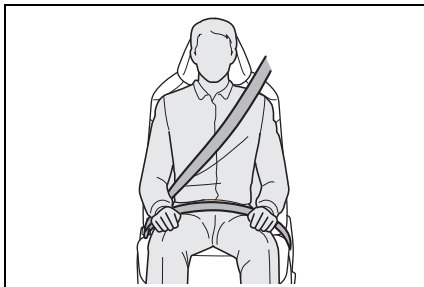
**Correct use of the seat belts**

- Extend the shoulder belt so that it comes fully over the shoulder, but does not come into contact with the neck or slide off the shoulder.

- Position the lap belt as low as possible over the hips.
- Adjust the position of the seatback.  
Sit up straight and well back in the seat.
- Do not twist the seat belt.

**■ Child seat belt usage**

The seat belts of your vehicle were principally designed for persons of adult size.

- Use a child restraint system appropriate for the child, until the child becomes large enough to properly wear the vehicle's seat belt. (→P.50)
- When the child becomes large enough to properly wear the vehicle's seat belt, follow the instructions regarding seat belt usage. (→P.29)

**■ Seat belt extender**

If your seat belts cannot be fastened securely because they are not long enough, a personalized seat belt extender is available from your Toyota dealer free of charge.

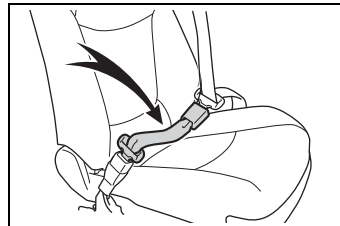
**⚠ WARNING****■ Using a seat belt extender**

Observe the following precautions to reduce the risk of injury in the event of sudden braking, sudden swerving or an accident. Failure to do so may cause death or serious injury.

**⚠ WARNING**

- Do not wear the seat belt extender if you can fasten the seat belt without the extender.
- Do not use the seat belt extender when installing a child restraint system because the belt will not securely hold the child restraint system, increasing the risk of death or serious injury in the event of an accident.
- The personalized extender may not be safe on another vehicle, when used by another person, or at a different seating position other than the one originally intended.

**⚠ NOTICE****■ When using a seat belt extender**

When releasing the seat belt, press on the buckle release button on the extender, not on the seat belt. This helps prevent damage to the vehicle interior and the extender itself.

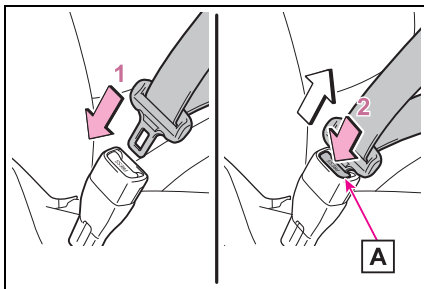
**Fastening and releasing the seat belt**

- 1 To fasten the seat belt, push the plate into the buckle until

a click sound is heard.

- 2 To release the seat belt, press the release button **A**.

**■ Emergency locking retractor (ELR)**

The retractor will lock the belt during a sudden stop or on impact. It may also lock if you lean forward too quickly. A slow, easy motion will allow the belt to extend so that you can move around fully.

**■ Automatic locking retractor (ALR)**

When a passenger's shoulder belt is completely extended and then retracted even slightly, the belt is locked in that position and cannot be extended. This feature is used to hold a child restraint system (CRS) firmly. To free the belt again, fully retract the belt and then pull the belt out once more.

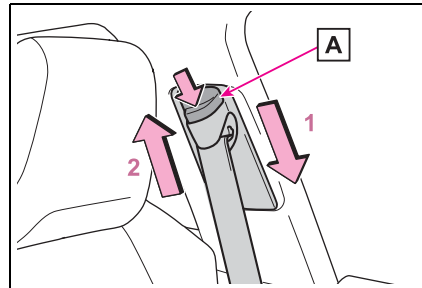
**Adjusting the seat belt shoulder anchor height (front seats)**

- 1 Push the seat belt shoulder anchor down while pressing the release button **A**.
- 2 Push the seat belt shoulder anchor up.

Move the height adjuster up and down as needed until you hear a

click.

**⚠ WARNING**

■ **Adjustable shoulder anchor**

Always make sure the shoulder belt is positioned across the center of your shoulder. The belt should be kept away from your neck, but not falling off your shoulder. Failure to do so could reduce the amount of protection in an accident and cause death or serious injuries in the event of a sudden stop, sudden swerve or accident.

**Seat belt pretensioners (front seats)**

The pretensioners help the seat belts to quickly restrain the occupants by retracting the seat belts when the vehicle is subjected to certain types of severe frontal or side collision or a vehicle rollover.

The pretensioners do not activate in the event of a minor frontal impact, a minor side impact or a rear impact.

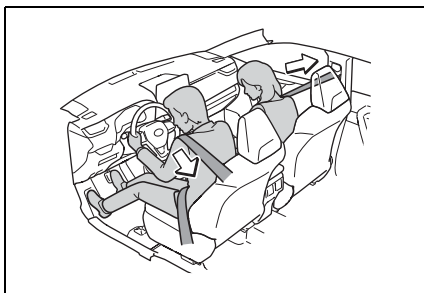

■ **Replacing the belt after the pretensioner has been activated**

If the vehicle is involved in multiple collisions, the pretensioner will acti-

vate for the first collision, but will not activate for the second or subsequent collisions.

**⚠ WARNING**

■ **Seat belt pretensioners**

Observe the following precautions to reduce the risk of injury in the event of sudden braking, sudden swerving or an accident. Failure to do so may cause death or serious injury.

- Do not place anything, such as a cushion, on the front passenger's seat. Doing so will disperse the passenger's weight, which prevents the sensor from detecting the passenger's weight properly. As a result, the seat belt pretensioner for the front passenger's seat may not activate in the event of a collision.
- If the pretensioner has activated, the SRS warning light will come on. In that case, the seat belt cannot be used again and must be replaced at your Toyota dealer.



## SRS airbags

The SRS airbags inflate when the vehicle is subjected to certain types of severe impacts that may cause significant injury to the occupants. They work together with the seat belts to help reduce the risk of death or serious injury.

### SRS airbag system

#### ■ Location of the SRS airbags

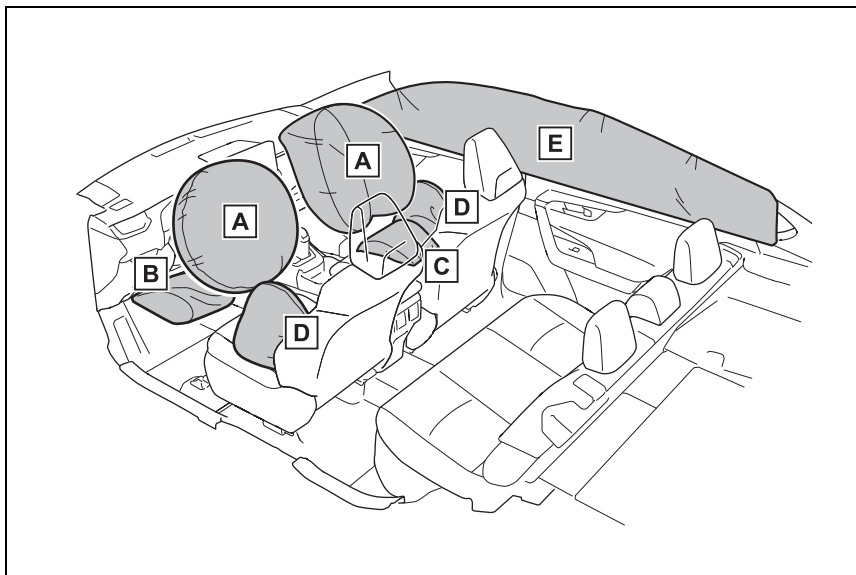

#### ► SRS front airbags

##### **A** SRS driver airbag/front passenger airbag

Can help protect the head and chest of the driver and front passenger from impact with interior components

##### **B** SRS knee airbag

Can help provide driver protection

##### **C** SRS seat cushion airbag

Can help restrain the front passenger

#### ► SRS side and curtain shield airbags

##### **D** SRS side airbags

Can help protect the torso of the front seat occupants

**E** SRS curtain shield airbags

- Can help protect primarily the head of occupants in the outer seats
- Can help prevent the occupants from being thrown from the vehicle in the event of vehicle rollover

■ **SRS airbag system components**

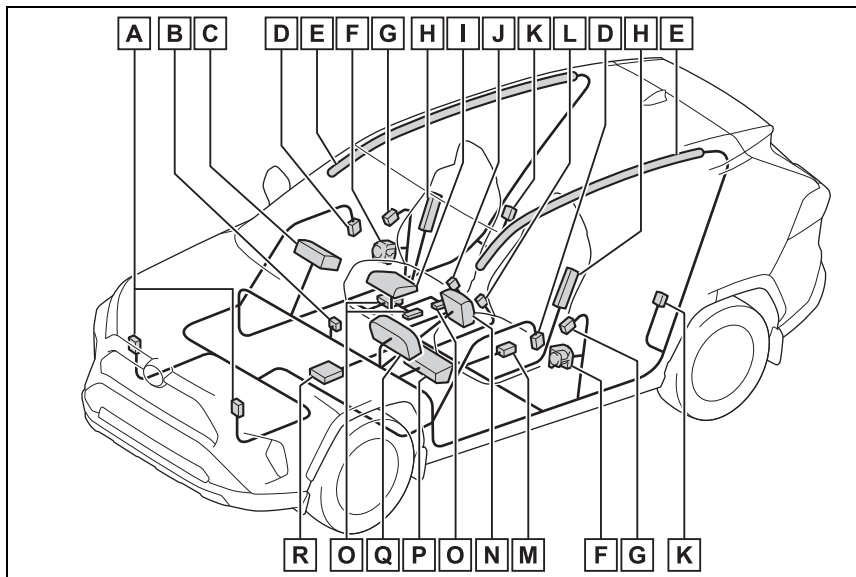

- A** Front impact sensors
- B** “AIR BAG ON” and “AIR BAG OFF” indicator lights
- C** Front passenger airbag
- D** Side impact sensors (front door)
- E** Curtain shield airbags
- F** Seat belt pretensioners and force limiters
- G** Side impact sensors (front)
- H** Side airbags
- I** Seat cushion airbag
- J** Front passenger’s seat belt buckle switch
- K** Side impact sensors (rear)
- L** Driver’s seat belt buckle switch
- M** Driver’s seat position sensor

- N** Driver airbag
- O** Front passenger occupant classification system (ECU and sensors)
- P** Knee airbag
- Q** SRS warning light
- R** Airbag sensor assembly

Your vehicle is equipped with ADVANCED AIRBAGS designed based on the US motor vehicle safety standards (FMVSS208). The airbag sensor assembly (ECU) controls airbag deployment based on information obtained from the sensors etc. shown in the system components diagram above. This information includes crash severity and occupant information. As the airbags deploy, a chemical reaction in the inflators quickly fills the airbags with non-toxic gas to help restrain the motion of the occupants.

#### ■ If the SRS airbags deploy (inflate)

- Slight abrasions, burns, bruising etc., may be sustained from SRS airbags, due to the extremely high speed deployment (inflation) by hot gases.
- A loud noise and white powder will be emitted.
- Parts of the airbag module (steering wheel hub, airbag cover and inflator) as well as the front seats, parts of the front and rear pillars, and roof side rails, may be hot for several minutes. The airbag itself may also be hot.
- The windshield may crack.
- The brakes and stop lights will be controlled automatically. (→P.361)
- The interior lights will turn on automatically. (→P.526)
- The emergency flashers will turn on automatically. (→P.618)
- Fuel supply to the engine will be stopped. (→P.627)
- For Safety Connect subscribers, if any of the following situations

occur, the system is designed to send an emergency call to the response center, notifying them of the vehicle's location (without needing to push the "SOS" button) and an agent will attempt to speak with the occupants to ascertain the level of emergency and assistance required. If the occupants are unable to communicate, the agent automatically treats the call as an emergency and helps to dispatch the necessary emergency services. (→P.65)

- An SRS airbag is deployed.
- A seat belt pretensioner is activated.
- The vehicle is involved in a severe rear-end collision.

#### ■ SRS airbag deployment conditions (SRS front airbags)

- The SRS front airbags will deploy in the event of an impact that exceeds the set threshold level (the level of force corresponding to an approximately 12-18 mph [20-30 km/h] frontal collision with a fixed wall that does not move or deform).

However, this threshold velocity will

be considerably higher in the following situations:

- If the vehicle strikes an object, such as a parked vehicle or sign pole, which can move or deform on impact
- If the vehicle is involved in an underride collision, such as a collision in which the front of the vehicle underrides, or goes under, the bed of a truck
- Depending on the type of collision, it is possible that only the seat belt pretensioners will activate.
- The SRS front airbags for the front passenger will not activate if there is no passenger sitting in the front passenger seat. However, the SRS front airbags for the front passenger may deploy if luggage is put in the seat, even if the seat is unoccupied.
- The SRS seat cushion airbag on the front passenger seat will not operate if the occupant is not wearing a seat belt.

■ **SRS airbag deployment conditions (SRS side and curtain shield airbags)**

- The SRS side and curtain shield airbags will deploy in the event of an impact that exceeds the set threshold level (the level of force corresponding to the impact force produced by an approximately 3300 lb. [1500 kg] vehicle colliding with the vehicle cabin from a direction perpendicular to the vehicle orientation at an approximate speed of 12 -18 mph [20 -30 km/h]).
- Both SRS curtain shield airbags may deploy in the event of a severe side collision.
- Both SRS curtain shield airbags will deploy in the event of vehicle rollover.
- Both SRS curtain shield airbags may also deploy in the event of a severe frontal collision.

■ **Conditions under which the SRS airbags may deploy (inflate), other than a collision**

The SRS front airbags and SRS curtain shield airbags may also deploy if a serious impact occurs to the underside of your vehicle. Some examples are shown in the illustration.

- Hitting a curb, edge of pavement or hard surface
- Falling into or jumping over a deep hole
- Landing hard or falling

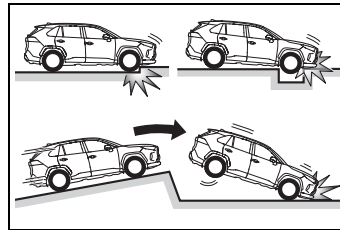

The SRS curtain shield airbags may also deploy under the situations shown in the illustration.

- The angle of vehicle tip-up is marginal.
- The vehicle skids and hits a curb stone.

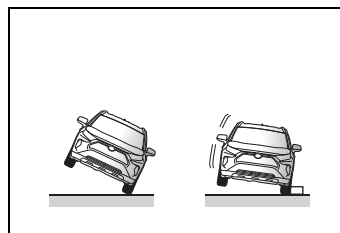

■ **Types of collisions that may not deploy the SRS airbags (SRS front airbags)**

The SRS front airbags do not generally inflate if the vehicle is involved in a side or rear collision, if it rolls over, or if it is involved in a low-speed frontal collision. But, whenever a collision of any type causes sufficient forward deceleration of the vehicle, deployment of the SRS

front airbags may occur.

- Collision from the side
- Collision from the rear
- Vehicle rollover

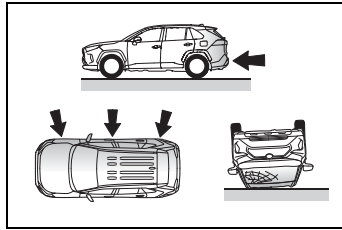

**■ Types of collisions that may not deploy the SRS airbags (SRS side and curtain shield airbags)**

The SRS side and curtain shield airbags may not activate if the vehicle is subjected to a collision from the side at certain angles, or a collision to the side of the vehicle body other than the passenger compartment.

- Collision from the side to the vehicle body other than the passenger compartment
- Collision from the side at an angle

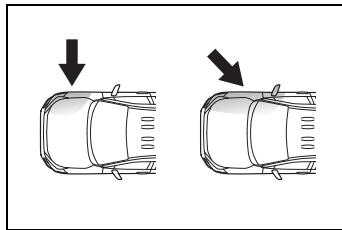

The SRS side airbags do not generally inflate if the vehicle is involved in a frontal or rear collision, if it rolls over, or if it is involved in a low-speed side collision.

- Collision from the front
- Collision from the rear
- Vehicle rollover

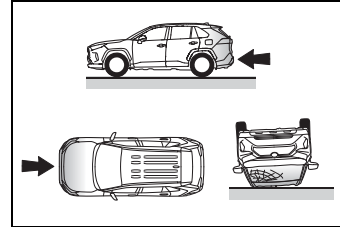

The SRS curtain shield airbags do not generally inflate if the vehicle is involved in a rear collision, if it pitches end over end, or if it is involved in a low-speed side or low-speed frontal collision.

- Collision from the rear
- Pitching end over end

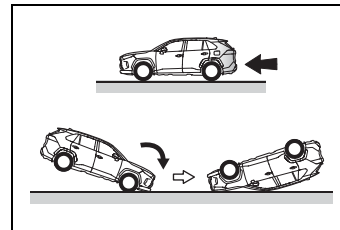

**■ When to contact your Toyota dealer**

In the following cases, the vehicle will require inspection and/or repair. Contact your Toyota dealer as soon as possible.

- Any of the SRS airbags have been inflated.
- The front of the vehicle is damaged or deformed, or was involved in an accident that was not severe enough to cause the SRS front airbags to inflate.

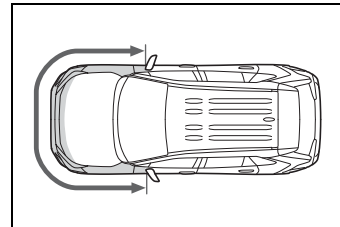

- A portion of a door or its surrounding area is damaged, deformed or has had a hole made in it, or the

vehicle was involved in an accident that was not severe enough to cause the SRS side and curtain shield airbags to inflate.

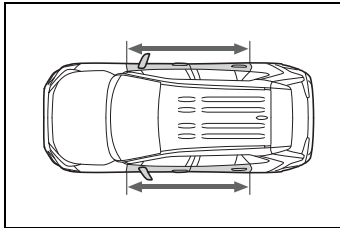

- The pad section of the steering wheel, dashboard near the front passenger airbag or lower portion of the instrument panel is scratched, cracked, or otherwise damaged.

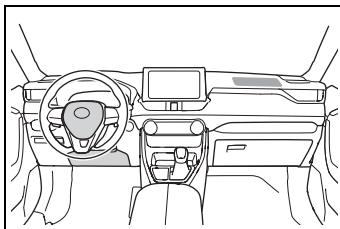

- The front passenger's seat cushion surface is scratched, cracked, or otherwise damaged.

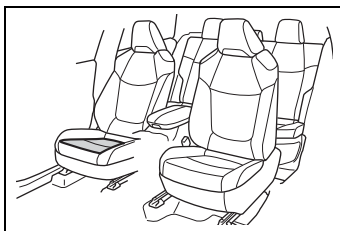

- The surface of the seats with the SRS side airbag is scratched, cracked, or otherwise damaged.

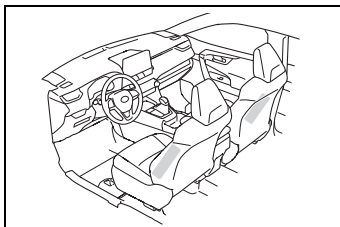

- The portion of the front pillars, rear pillars or roof side rail garnishes (padding) containing the SRS curtain shield airbags inside is scratched, cracked, or otherwise damaged.

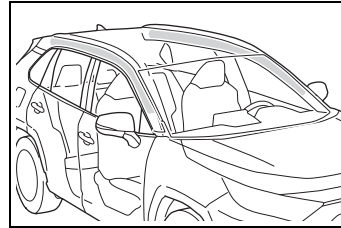

### **⚠ WARNING**

#### **■ SRS airbag precautions**

Observe the following precautions regarding the SRS airbags. Failure to do so may cause death or serious injury.

- The driver and all passengers in the vehicle must wear their seat belts properly. The SRS airbags are supplemental devices to be used with the seat belts.
- The SRS driver airbag deploys with considerable force, and can cause death or serious injury especially if the driver is very close to the airbag. The National Highway Traffic Safety Administration (NHTSA) advises:

Since the risk zone for the driver's airbag is the first 2 - 3 in. (50 - 75 mm) of inflation, placing yourself 10 in. (250 mm) from your driver airbag provides you with a clear margin of safety. This distance is measured from the center of the steering wheel to your breastbone. If you sit less than 10 in. (250 mm) away now, you can change your driving position in several ways:

**⚠ WARNING**

- Move your seat to the rear as far as you can while still reaching the pedals comfortably.
- Slightly recline the back of the seat.  
Although vehicle designs vary, many drivers can achieve the 10 in. (250 mm) distance, even with the driver seat all the way forward, simply by reclining the back of the seat somewhat. If reclining the back of your seat makes it hard to see the road, raise yourself by using a firm, non-slippery cushion, or raise the seat if your vehicle has that feature.
- If your steering wheel is adjustable, tilt it downward. This points the airbag toward your chest instead of your head and neck.

The seat should be adjusted as recommended by NHTSA above, while still maintaining control of the foot pedals, steering wheel, and your view of the instrument panel controls.

- If the seat belt extender has been connected to the front seat belt buckles but the seat belt extender has not also been fastened to the latch plate of the seat belt, the SRS front airbags will judge that the driver and front passenger are wearing the seat belt even though the seat belt has not been connected. In this case, the SRS front airbags may not activate correctly in a collision, resulting in death or serious injury in the event of a collision. Be sure to wear the seat belt with the seat belt extender.

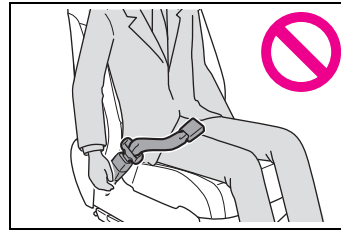

- The SRS front passenger airbag also deploys with considerable force, and can cause death or serious injury especially if the front passenger is very close to the airbag. The front passenger seat should be as far from the airbag as possible with the seat-back adjusted, so the front passenger sits upright.
- Improperly seated and/or restrained infants and children can be killed or seriously injured by a deploying airbag. An infant or child who is too small to use a seat belt should be properly secured using a child restraint system. Toyota strongly recommends that all infants and children be placed in the rear seats of the vehicle and properly restrained. The rear seats are safer for infants and children than the front passenger seat. (→P.50)

**⚠ WARNING**

- Do not sit on the edge of the seat or lean against the dashboard.

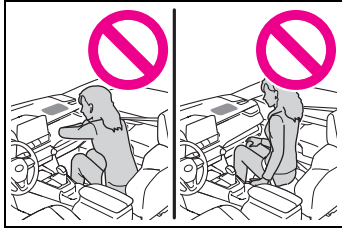

- Do not allow a child to stand in front of the SRS front passenger airbag unit or sit on the knees of a front passenger.

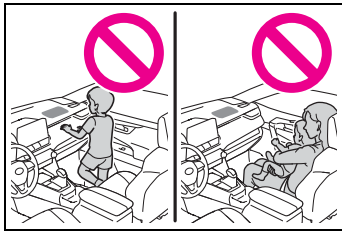

- Do not allow the front seat occupants to hold items on their knees.
- Do not lean against the door, the roof side rail or the front, side and rear pillars.



- Do not allow anyone to kneel on the passenger seat toward the door or put their head or hands outside the vehicle.

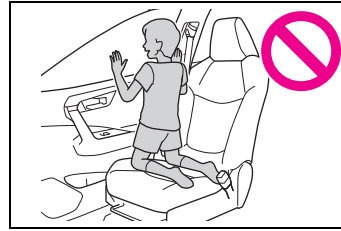

- Do not attach anything to or lean anything against areas such as the dashboard, steering wheel pad and lower portion of the instrument panel. These items can become projectiles when the SRS driver, front passenger and knee airbags deploy.

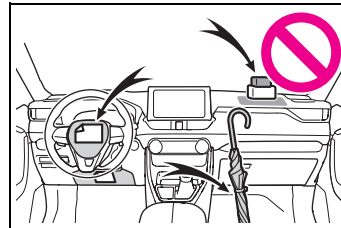

- Do not attach anything to areas such as a door, windshield, side windows, front or rear pillar, roof side rail and assist grip.

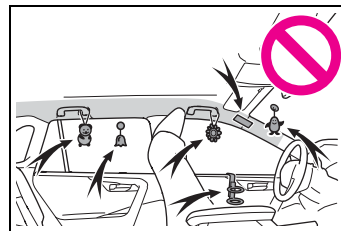



**⚠ WARNING**

- Vehicles without smart key system: Do not attach any heavy, sharp or hard objects such as keys and accessories to the key. The objects may restrict the SRS knee airbag inflation or be thrust into the driver's seat area by the force of the deploying airbag, thus causing a danger.

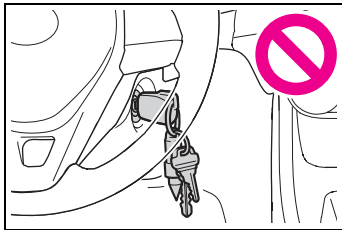

- Do not hang coat hangers or other hard objects on the coat hooks. All of these items could become projectiles and may cause death or serious injury, should the SRS curtain shield airbags deploy.
- If a vinyl cover is put on the area where the SRS knee airbag will deploy, be sure to remove it.
- Do not use seat accessories which cover the parts where the SRS side airbags and SRS seat cushion airbag inflate as they may interfere with inflation of the SRS airbags. Such accessories may prevent the side airbags and seat cushion airbag from activating correctly, disable the system or cause the side airbags and seat cushion airbag to inflate accidentally, resulting in death or serious injury.
- Do not strike or apply significant levels of force to the area of the SRS airbag components or the front doors. Doing so can cause the SRS airbags to malfunction.

- Do not touch any of the component parts immediately after the SRS airbags have deployed (inflated) as they may be hot.

- If breathing becomes difficult after the SRS airbags have deployed, open a door or side window to allow fresh air in, or leave the vehicle if it is safe to do so. Wash off any residue as soon as possible to prevent skin irritation.

- If the areas where the SRS airbags are stored, such as the steering wheel pad and front and rear pillar garnishes, are damaged or cracked, have them replaced by your Toyota dealer.

- Do not place anything, such as a cushion, on the front passenger's seat. Doing so will disperse the passenger's weight, which prevents the sensor from detecting the passenger's weight properly. As a result, the SRS front airbags for the front passenger may not deploy in the event of a collision.

**■ Modification and disposal of SRS airbag system components**

Do not dispose of your vehicle or perform any of the following modifications without consulting your Toyota dealer. The SRS airbags may malfunction or deploy (inflate) accidentally, causing death or serious injury.

- Installation, removal, disassembly and repair of the SRS airbags

**WARNING**

- Repairs, modifications, removal or replacement of the steering wheel, instrument panel, dashboard, seats or seat upholstery, front, side and rear pillars, roof side rails, front door panels, front door trims or front door speakers
- Modifications to the front door panel (such as making a hole in it)
- Repairs or modifications of the front fender, front bumper, or side of the occupant compartment
- Installation of a grille guard (bull bars, kangaroo bar, etc.), snow plows, winches or roof luggage carrier
- Modifications to the vehicle's suspension system
- Installation of electronic devices such as mobile two-way radios and CD players
- Modifications to your vehicle for a person with a physical disability

## Front passenger occupant classification system

Your vehicle is equipped with a front passenger occupant classification system. This system detects the conditions of the front passenger seat and activates or deactivates the front passenger airbag and seat cushion airbag in the front passenger side.

### System components



- A** SRS warning light
- B** Driver's and front passenger's seat belt reminder light
- C** "AIR BAG OFF" indicator light
- D** "AIR BAG ON" indicator light

#### **⚠ WARNING**

#### **■ Front passenger occupant classification system precautions**

Observe the following precautions regarding the front passenger occupant classification system. Failure to do so may cause death or serious injury.

- Wear the seat belt properly.

- Make sure the front passenger's seat belt plate has not been left inserted into the buckle before someone sits in the front passenger seat.

**WARNING**

- Make sure the “AIR BAG OFF” indicator light is not illuminated when using the seat belt extender for the front passenger seat. If the “AIR BAG OFF” indicator light is illuminated, disconnect the extender tongue from the seat belt buckle, and reconnect the seat belt. Reconnect the seat belt extender after making sure the “AIR BAG ON” indicator light is illuminated. If you use the seat belt extender while the “AIR BAG OFF” indicator light is illuminated, the SRS airbags for the front passenger will not activate, which could cause death or serious injury in the event of a collision.
- Do not apply a heavy load to the front passenger seat or equipment (e.g. seatback pocket).
- Do not put weight on the front passenger seat by putting your hands or feet on the front passenger seat seatback from the rear passenger seat.
- Do not let a rear passenger lift the front passenger seat with their feet or press on the seatback with their legs.
- Do not put objects under the front passenger seat.
- Do not recline the front passenger seatback so far that it touches a rear seat. This may cause the “AIR BAG OFF” indicator light to be illuminated, which indicates that the SRS airbags for the front passenger will not activate in the event of a severe accident. If the seatback touches the rear seat, return the seatback to a position where it does not touch the rear seat. Keep the front passenger seatback as upright as possible when the vehicle is moving. Reclining the seatback excessively may lessen the effectiveness of the seat belt system.
- If an adult sits in the front passenger seat, the “AIR BAG ON” indicator light is illuminated. If the “AIR BAG OFF” indicator is illuminated, ask the passenger to sit up straight, well back in the seat, feet on the floor, and with the seat belt worn correctly. If the “AIR BAG OFF” indicator still remains illuminated, either ask the passenger to move to the rear seat, or if that is not possible, move the front passenger seat fully rearward.
- When it is unavoidable to install a forward-facing child restraint system on the front passenger seat, install the child restraint system on the front passenger seat in the proper order. (→P.53)
- Do not modify or remove the front seats.
- Do not kick the front passenger seat or subject it to severe impact. Otherwise, the SRS warning light may come on to indicate a malfunction of the front passenger occupant classification system. In this case, contact your Toyota dealer immediately.

**⚠ WARNING**

- Child restraint systems installed on the rear seat should not contact the front seatbacks.
- Do not use a seat accessory, such as a cushion and seat cover, that covers the seat cushion surface.
- Do not modify or replace the upholstery of the front seat.
- Adjust the front passenger seat so that the head restraint does not touch the ceiling. If the head restraint is left in contact with the ceiling, the system may not detect the front passenger properly, leading to improper operation of the airbags.

**Condition and operation in the front passenger occupant classification system**

■ **Adult\*1**

Indicator/warning light	“AIR BAG ON” and “AIR BAG OFF” indicator lights	“AIR BAG ON”
	SRS warning light	Off
	Driver’s and front passenger’s seat belt reminder light	Off*2 or flashing*3
Devices	Front passenger airbag	Activated
	Front passenger seat cushion airbag	Activated *2 or deactivated*3

■ Child\*4

Indicator/warning light	“AIR BAG ON” and “AIR BAG OFF” indicator lights	“AIR BAG OFF” or “AIR BAG ON”*4
	SRS warning light	Off
	Driver’s and front passenger’s seat belt reminder light	Off*2 or flashing*3
Devices	Front passenger airbag	Deactivated or activated*4
	Front passenger seat cushion airbag	Deactivated or activated*2, 4

■ Child restraint system with infant\*5

Indicator/warning light	“AIR BAG ON” and “AIR BAG OFF” indicator lights	“AIR BAG OFF”*6
	SRS warning light	Off
	Driver’s and front passenger’s seat belt reminder light	Off*2 or flashing*3
Devices	Front passenger airbag	Deactivated
	Front passenger seat cushion airbag	

■ Unoccupied

Indicator/warning light	“AIR BAG ON” and “AIR BAG OFF” indicator lights	“AIR BAG OFF”
	SRS warning light	Off
	Driver’s and front passenger’s seat belt reminder light	
Devices	Front passenger airbag	Deactivated
	Front passenger seat cushion airbag	

■ **There is a malfunction in the system**

Indicator/warning light	"AIR BAG ON" and "AIR BAG OFF" indicator lights	"AIR BAG OFF"
	SRS warning light	On
	Driver's and front passenger's seat belt reminder light	
Devices	Front passenger airbag	Deactivated
	Front passenger seat cushion airbag	

\*1: The system judges a person of adult size as an adult. When a smaller adult sits in the front passenger seat, the system may not recognize him/her as an adult depending on his/her physique and posture.

\*2: In the event the front passenger is wearing a seat belt.

\*3: In the event the front passenger does not wear a seat belt.

\*4: For some children, child in seat, child in booster seat or child in convertible seat, the system may not recognize him/her as a child. Factors which may affect this can be the physique or posture.

\*5: Never install a rear-facing child restraint system on the front passenger seat. A forward-facing child restraint system should only be installed on the front passenger seat when it is unavoidable. (→P.53)

\*6: In case the indicator light is not illuminated, consult this manual on how to install the child restraint system properly. (→P.50)

## Exhaust gas precautions

**Harmful substance to the human body is included in exhaust gases if inhaled.**

### **WARNING**

Exhaust gases contain harmful carbon monoxide (CO), which is colorless and odorless. Observe the following precautions. Failure to do so may cause exhaust gases to enter the vehicle and may lead to an accident caused by light-headedness, or may lead to death or a serious health hazard.

#### ■ **Important points while driving**

- Keep the back door closed.
- If you smell exhaust gases in the vehicle even when the back door is closed, open the side windows and have the vehicle inspected at your Toyota dealer as soon as possible.

#### ■ **When parking**

- If the vehicle is in a poorly ventilated area or a closed area, such as a garage, stop the engine.
- Do not leave the vehicle with the engine running for a long time.  
If such a situation cannot be avoided, park the vehicle in an open space and ensure that exhaust fumes do not enter the vehicle interior.

- Do not leave the engine running in an area with snow build-up, or where it is snowing. If snowbanks build up around the vehicle while the engine is running, exhaust gases may collect and enter the vehicle.

#### ■ **Exhaust pipe**

The exhaust system needs to be checked periodically. If there is a hole or crack caused by corrosion, damage to a joint or abnormal exhaust noise, be sure to have the vehicle inspected and repaired by your Toyota dealer.



## Riding with children

**Observe the following precautions when children are in the vehicle.**

**Use a child restraint system appropriate for the child, until the child becomes large enough to properly wear the vehicle's seat belt.**

- It is recommended that children sit in the rear seats to avoid accidental contact with the shift lever, wiper switch, etc.
- Use the rear door child-protector lock or the window lock switch to avoid children opening the door while driving or operating the power window accidentally.  
(→P.112, 158)
- Do not let small children operate equipment which may catch or pinch body parts, such as the power window, hood, back door, seats, etc.

### **WARNING**

#### **■ When children are in the vehicle**

Never leave children unattended in the vehicle, and never allow children to have or use the key.

Children may be able to start the vehicle or shift the vehicle into neutral. There is also a danger that children may injure themselves by playing with the side windows, the moon roof (if equipped), the panoramic moon roof (if equipped) or other features of the vehicle. In addition, heat build-up or extremely cold temperatures inside the vehicle can be fatal to children.

## Child restraint systems

**Before installing a child restraint system in the vehicle, there are precautions that need to be observed, different types of child restraint systems, as well as installation methods, etc., written in this manual.**

Use a child restraint system when riding with a small child that cannot properly use a seat belt. For the child's safety, install the child restraint system to a rear seat. Be sure to follow the installation method that is in the operation manual enclosed with the restraint system.

### Table of contents

Points to remember: P.50

Child restraint system: P.52

When using a child restraint system: P.53

Child restraint system installation method

- Fixed with a seat belt: P.54
- Fixed with a child restraint LATCH anchor: P.59
- Using an anchor bracket (for top tether strap): P.61

### Points to remember

The laws of all 50 states of the U.S.A. as well as Canada now require the use of child restraint systems.

- Prioritize and observe the warnings, as well as the laws and regulations for child restraint systems.
- Use a child restraint system until the child becomes large enough to properly wear the vehicle's seat belt.
- Choose a child restraint system that suits your vehicle and is appropriate to the age and size of the child.

### WARNING

#### ■ When a child is riding

Observe the following precautions.

Failure to do so may result in death or serious injury.

- For effective protection in automobile accidents and sudden stops, a child must be properly restrained, using a seat belt or child restraint system which is correctly installed. For installation details, refer to the operation manual enclosed with the child restraint system. General installation instructions are provided in this manual.

**WARNING**

- Toyota strongly urges the use of a proper child restraint system that conforms to the weight and size of the child, installed on the rear seat. According to accident statistics, the child is safer when properly restrained in the rear seat than in the front seat.
- Holding a child in your or someone else's arms is not a substitute for a child restraint system. In an accident, the child can be crushed against the windshield or between the holder and the interior of the vehicle.

**■ Handling the child restraint system**

If the child restraint system is not properly fixed in place, the child or other passengers may be seriously injured or even killed in the event of sudden braking, sudden swerving, or an accident.

- If the vehicle were to receive a strong impact from an accident, etc., it is possible that the child restraint system has damage that is not readily visible. In such cases, do not reuse the restraint system.
- Make sure you have complied with all installation instructions provided with the child restraint system manufacturer and that the system is properly secured.
- Keep the child restraint system properly secured on the seat even if it is not in use. Do not store the child restraint system unsecured in the passenger compartment.
- If it is necessary to detach the child restraint system, remove it from the vehicle or store it securely in the luggage compartment.

**Child restraint system**

■ **Types of child restraint system installation methods**

Confirm with the operation manual enclosed with the child restraint system about the installation of the child restraint system.

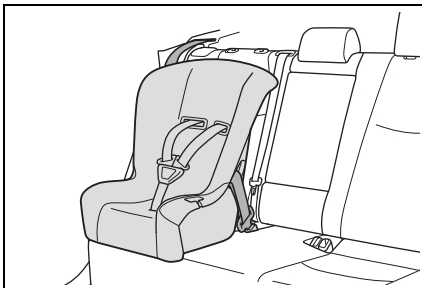
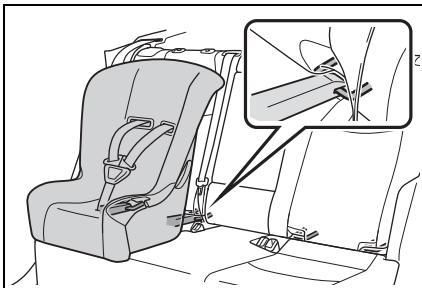
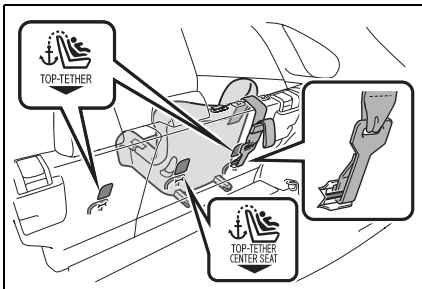
Installation method	Page
<p>Seat belt attachment</p>	 <p>P.54</p>
<p>Child restraint LATCH anchors attachment</p>	 <p>P.59</p>
<p>Anchor brackets (for top tether strap) attachment</p>	 <p>P.61</p>

### When using a child restraint system

#### ■ When installing a child restraint system to a front passenger seat

For the safety of a child, install a child restraint system to a rear seat. When installing a child restraint system to the front passenger seat is unavoidable, adjust the seat as follows and install the child restraint system.

- Adjust the seatback angle to the most upright position.
- Move the front seat fully rearward.
- If the head restraint interferes with the child restraint system installation and the head restraint can be removed, remove the head restraint. Otherwise, put the head restraint in the upper most position.

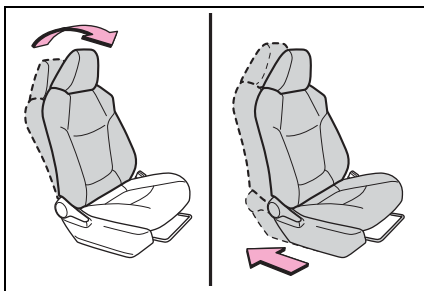

### ⚠ WARNING

#### ■ When using a child restraint system

Observe the following precautions.

Failure to do so may result in death or serious injury.

- Never install a rear-facing child restraint system on the front passenger seat even if the "AIR BAG OFF" indicator light is illuminated. In the event of an accident, the force of the rapid inflation of the front passenger airbag can cause death or serious injury to the child if the rear-facing child restraint system is installed on the front passenger seat.
- A forward-facing child restraint system may be installed on the front passenger seat only when it is unavoidable. A child restraint system that requires a top tether strap should not be used in the front passenger seat since there is no top tether strap anchor for the front passenger seat.

- A forward-facing child restraint system may be installed on the front passenger seat only when it is unavoidable. When installing a forward-facing child restraint system on the front passenger seat, adjust the seat-back angle to the most upright position, move the seat to the rearmost position, even if the "AIR BAG OFF" indicator light is illuminated.

If the head restraint interferes with the child restraint system installation and the head restraint can be removed, remove the head restraint.

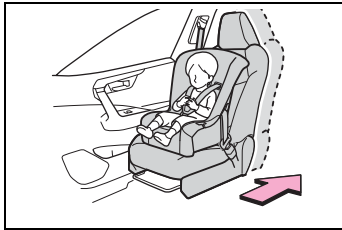

#### **⚠ WARNING**

- Do not allow the child to lean his/her head or any part of his/her body against the door or the area of the seat, front or rear pillars, or roof side rails from which the SRS side airbags or SRS curtain shield airbags deploy even if the child is seated in the child restraint system. It is dangerous if the SRS side and curtain shield airbags inflate, and the impact could cause death or serious injury to the child.



- When a booster seat is installed, always ensure that the shoulder belt is positioned across the center of the child's shoulder. The belt should be kept away from the child's neck, but not so that it could fall off the child's shoulder.

- Use a child restraint system suitable to the age and size of the child and install it to the rear seat.
- If the driver's seat interferes with the child restraint system and prevents it from being attached correctly, attach the child restraint system to the right-hand rear seat.

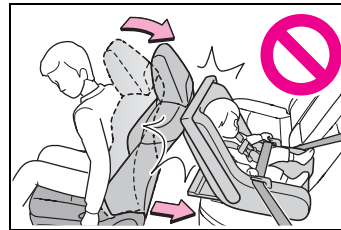

- Adjust the front passenger seat so that it does not interfere with the child restraint system.

#### **Child restraint system fixed with a seat belt**

A child restraint system for a small child or baby must itself be properly restrained on the seat with the lap portion of the lap/shoulder belt.

#### **■ Installing child restraint system using a seat belt (child restraint lock function belt)**

Install the child restraint system in accordance to the operation

manual enclosed with the child restraint system.

### ■ Rear-facing — Infant seat/convertible seat

- 1 Adjust the rear seat.

If there is a gap between the child restraint system and the seatback, adjust the seatback angle until good contact is achieved.

- 2 Place the child restraint system on the rear seat facing the rear of the vehicle.

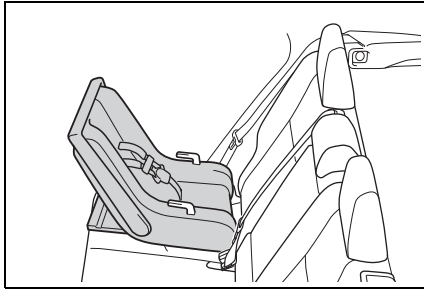

- 3 Run the seat belt through the child restraint system and insert the plate into the buckle. Make sure that the belt is not twisted.

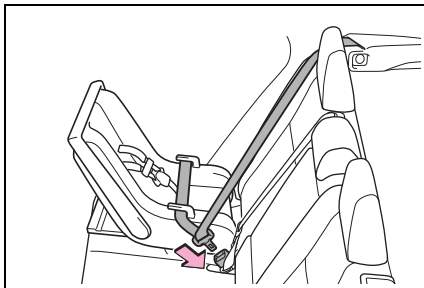

- 4 Fully extend the shoulder belt and allow it to retract to put it

in lock mode. In lock mode, the belt cannot be extended.

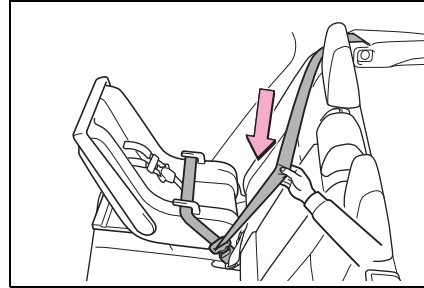

- 5 While pushing the child restraint system down into the rear seat, allow the shoulder belt to retract until the child restraint system is securely in place.

After the shoulder belt has retracted to a point where there is no slack in the belt, pull the belt to check that it cannot be extended.

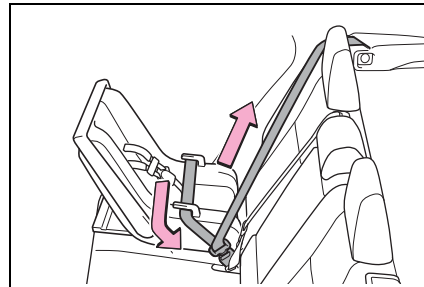

- 6 After installing the child restraint system, rock it back and forth to ensure that it is installed securely. (→P.58)

### ■ Forward-facing — Convertible seat

- 1 Adjust the seat.

When using the front passenger seat: If installing the child restraint system to the front passenger seat is unavoidable, refer to P.53 for front passenger seat adjustment.

When using the rear seat: If there is a gap between the child restraint system and the seatback, adjust the seatback angle until good contact is achieved.

- 2 If the head restraint interferes with the child restraint system installation and the head restraint can be removed, remove the head restraint. (→P.141)

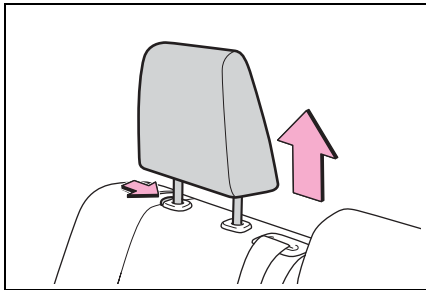

- 3 Place the child restraint system on the seat facing the front of the vehicle.

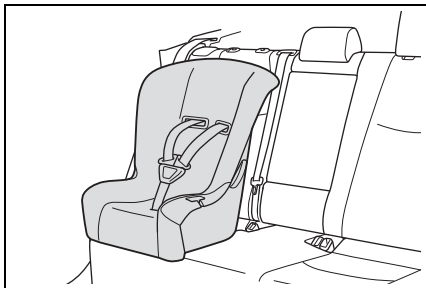

- 4 Run the seat belt through the child restraint system and insert the plate into the

buckle. Make sure that the belt is not twisted.

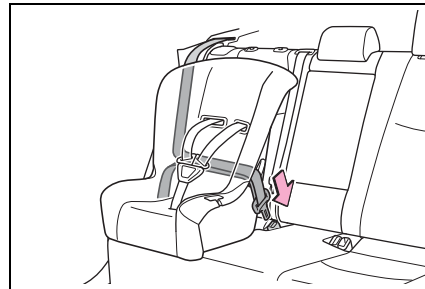

- 5 Fully extend the shoulder belt and allow it to retract to put it in lock mode. In lock mode, the belt cannot be extended.

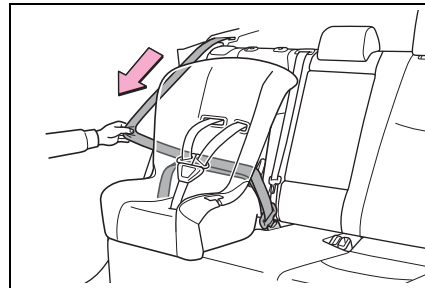

- 6 While pushing the child restraint system into the rear seat, allow the shoulder belt to retract until the child restraint system is securely in place.

After the shoulder belt has retracted to a point where there is no slack in the belt, pull the belt to



check that it cannot be extended.

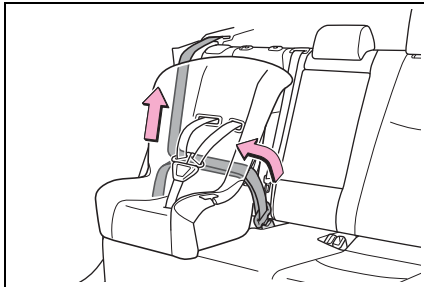

- 7 If the child restraint has a top tether strap, follow the child restraint manufacturer's operation manual regarding the installation, using the top tether strap to latch onto the top tether strap anchor. (→P.61)

- 8 After installing the child restraint system, rock it back and forth to ensure that it is installed securely. (→P.58)

#### ■ Booster seat

- 1 If installing the child restraint system to the front passenger seat is unavoidable, refer to P.53 for front passenger seat adjustment.
- 2 High back type: If the head restraint interferes with your child restraint system, and the head restraint can be

removed, remove the head restraint. (→P.141)

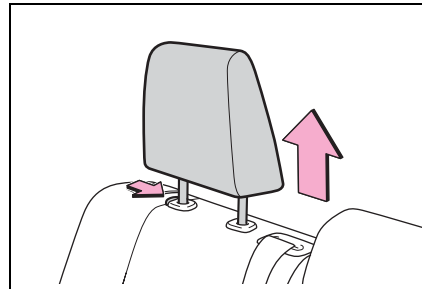

- 3 Place the child restraint system on the seat facing the front of the vehicle.

#### ► Booster type

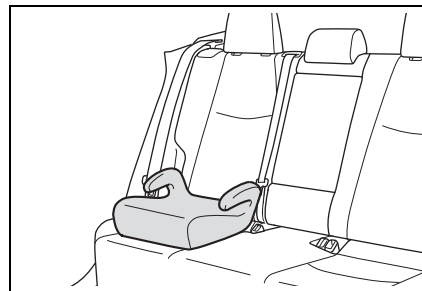

#### ► High back type

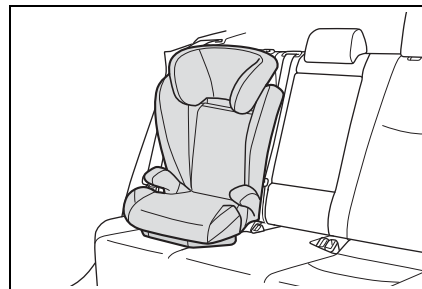

- 4 Sit the child in the child restraint system. Fit the seat belt to the child restraint system according to the manufacturer's instructions and insert the plate into the

buckle. Make sure that the belt is not twisted.

Check that the shoulder belt is correctly positioned over the child's shoulder and that the lap belt is as low as possible. (→P.29)

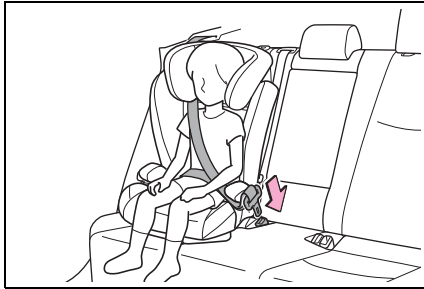

#### ■ Removing a child restraint system installed with a seat belt

Press the buckle release button and fully retract the seat belt.

When releasing the buckle, the child restraint system may spring up due to the rebound of the seat cushion. Release the buckle while holding down the child restraint system.

Since the seat belt automatically reels itself, slowly return it to the stowing position.

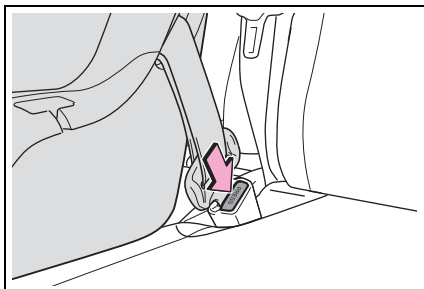

#### ⚠ WARNING

##### ■ When installing a child restraint system

Observe the following precautions. Failure to do so may result in death or serious injury.

- Do not allow children to play with the seat belt. If the seat belt becomes twisted around a child's neck, it may lead to choking or other serious injuries that could result in death. If this occurs and the buckle cannot be unfastened, scissors should be used to cut the belt.
- Ensure that the belt and plate are securely locked and the seat belt is not twisted.
- Shake the child restraint system left and right, and forward and backward to ensure that it has been securely installed.
- After securing a child restraint system, never adjust the seat.
- When a booster seat is installed, always ensure that the shoulder belt is positioned across the center of the child's shoulder. The belt should be kept away from the child's neck, but not so that it could fall off the child's shoulder.
- Follow all installation instructions provided by the child restraint system manufacturer.

- When securing some types of child restraint systems in rear seats, it may not be possible to properly use the seat belts in positions next to the child restraint without interfering with it or affecting seat belt effectiveness. Be sure your seat belt fits snugly across your shoulder and low on your hips. If it does not, or if it interferes with the child restraint, move to a different position. Failure to do so may result in death or serious injury.

- When installing a child restraint system in the center rear seat, adjust both seatbacks at the same angle. Otherwise, the child restraint system cannot be securely restrained and this may cause death or serious injuries in the event of sudden braking, sudden swerving or an accident.

#### ■ When installing a booster seat

To prevent the belt from going into ALR lock mode, do not fully extend the shoulder belt. ALR mode causes the belt to tighten only. This could cause injury or discomfort to the child. (→P.31)

#### ⚠ WARNING

#### ■ Do not use a seat belt extender

If a seat belt extender is used when installing a child restraint system, the seat belt will not securely hold the child restraint system, which could cause death or serious injury to the child or other passengers in the event of sudden braking, sudden swerving or an accident.

### Child restraint system fixed with a child restraint LATCH anchor

#### ■ Child restraint LATCH anchors

LATCH anchors are provided for the outboard rear seats.

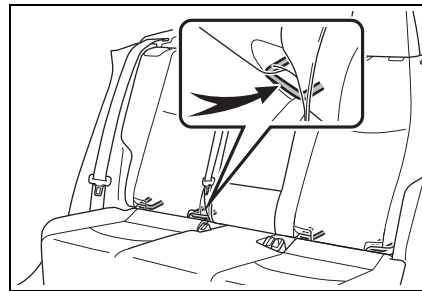

#### ■ When installing in the rear outboard seats

Install the child restraint system in accordance to the operation manual enclosed with the child restraint system.

- 1 Adjust the seat.

If there is a gap between the child restraint system and the seatback, adjust the seatback angle until good contact is achieved.

- 2 If the head restraint interferes with the child restraint system installation and the head restraint can be removed,

remove the head restraint.  
(→P.141)

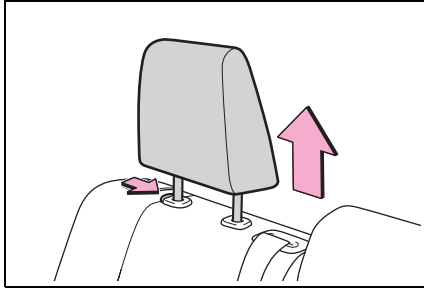

► With flexible lower attachments

3 Latch the hooks of the lower attachments onto the LATCH anchors.

For owners in Canada:  
The symbol on a child

restraint system indicates **A**  
the presence of a lower connector system.

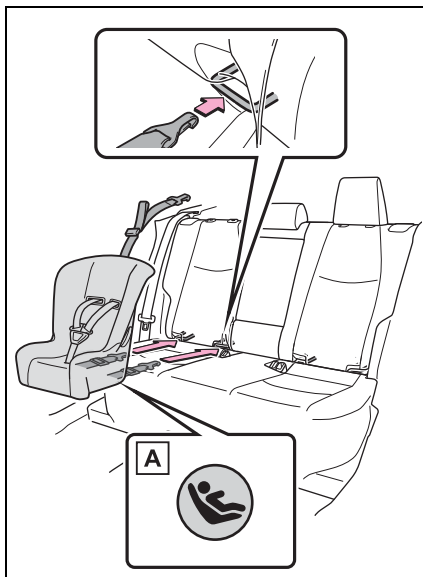

► With rigid lower attachments

3 Latch the buckles onto the LATCH anchors.

For owners in Canada:  
The symbol on a child

restraint system indicates **A**  
the presence of a lower connector system.

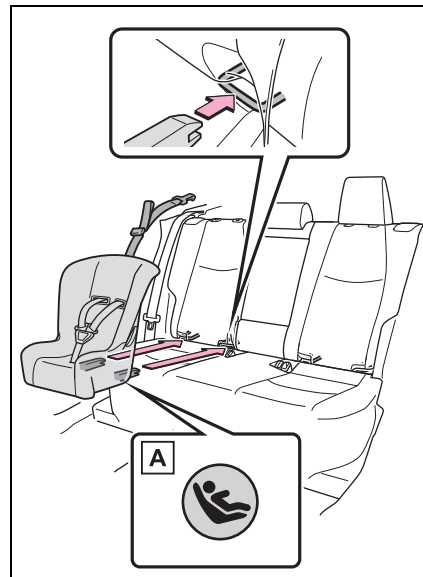

4 If the child restraint has a top tether strap, follow the child restraint manufacturer's operation manual regarding the installation, using the top tether strap to latch onto the top tether strap anchor.

(→P.61)

5 After installing the child restraint system, rock it back and forth to ensure that it is installed securely. (→P.58)

### ■ When installing in the rear center seat

There are no LATCH anchors behind the rear center seat. However, the inboard LATCH anchors of the outboard seats, which are 17.3 in. (440 mm) apart, can be used if the child restraint system manufacturer's instructions permit use of those anchors with the anchor spacing stated.

Child restraint systems with rigid lower attachments cannot be installed in the center seat. This type of child restraint system can only be installed in the outboard seat.

### ■ Laws and regulations pertaining to anchors

The LATCH system conforms to FMVSS225 or CMVSS210.2. Child restraint systems conforming to FMVSS213 or CMVSS213 specifications can be used. This vehicle is designed to conform to SAE J1819.



#### WARNING

#### ■ When installing a child restraint system

Observe the following precautions.

Failure to do so may result in death or serious injury.

- When using the LATCH anchors, be sure that there are no foreign objects around the anchors and that the seat belt is not caught behind the child restraint system.

- Follow all installation instructions provided by the child restraint system manufacturer.
- Never attach two child restraint system attachments to the same anchor. In a collision, one anchor may not be strong enough to hold two child restraint system attachments and may break. If the LATCH anchors are already in use, use the seat belt to install a child restraint system in the center seat.
- When securing some types of child restraint systems in rear seats, it may not be possible to properly use the seat belts in positions next to the child restraint without interfering with it or affecting seat belt effectiveness. Be sure your seat belt fits snugly across your shoulder and low on your hips. If it does not, or if it interferes with the child restraint, move to a different position. Failure to do so may result in death or serious injury.
- If the seat is adjusted, reconfirm the security of the child restraint system.

### Using an anchor bracket (for top tether strap)

#### ■ Anchor brackets (for top tether strap)

Anchor brackets are provided for each rear seat.

Use anchor brackets when fixing the top tether strap.

▶ Outboard rear seats

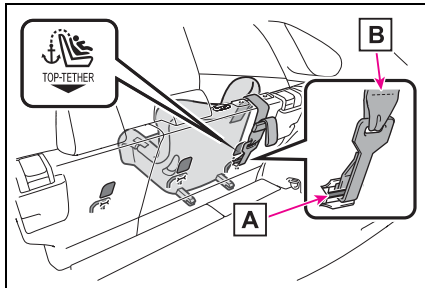

**A** Anchor brackets

**B** Top tether strap

▶ Center rear seat

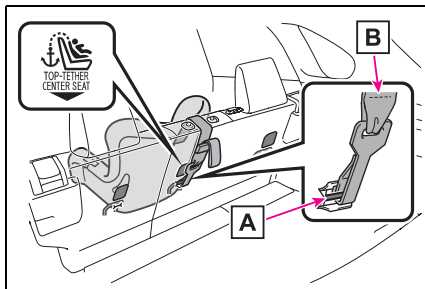

**A** Anchor bracket

**B** Top tether strap

■ **Fixing the top tether strap to the anchor bracket**

Install the child restraint system in accordance to the operation manual enclosed with the child restraint system.

▶ Outboard rear seats

- 1 Remove the head restraint. (→P.141)

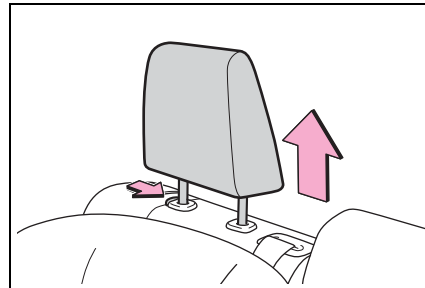

- 2 Latch the hook onto the anchor bracket and tighten the top tether strap.

Make sure the top tether strap is securely latched. (→P.58)

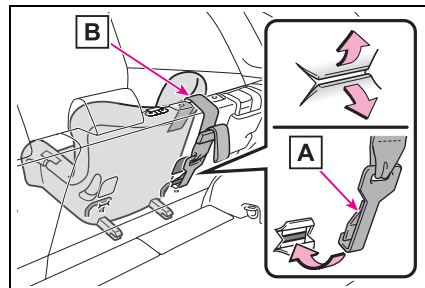

**A** Hook

**B** Top tether strap

- 3 If the head restraint does not interfere with the child

restraint system installation,  
install the head restraint.

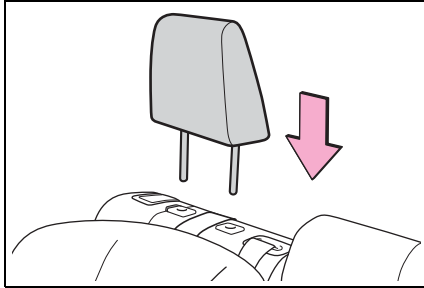

► Center rear seat

- 1 Adjust the head restraint to the upmost position.

If the head restraint interferes with your child restraint system, and the head restraint can be removed, remove the head restraint. (→P.141)

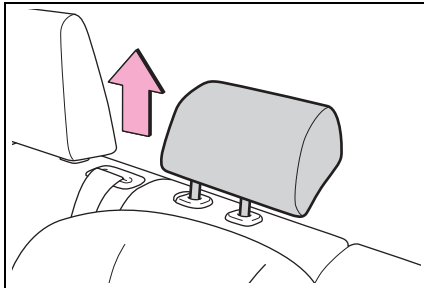

- 2 Latch the hook onto the anchor bracket and tighten the top tether strap.

Make sure the top tether strap is securely latched.

When installing the child restraint system with the head restraint being raised, be sure to have the top tether strap pass underneath the head restraint.

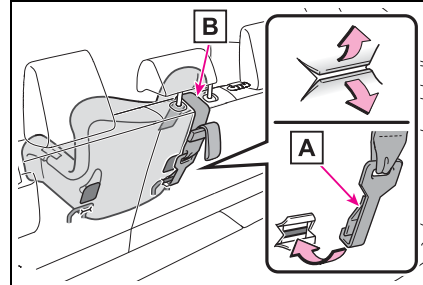

A Hook

B Top tether strap

■ **Laws and regulations pertaining to anchors**

The LATCH system conforms to FMVSS225 or CMVSS210.2. Child restraint systems conforming to FMVSS213 or CMVSS213 specifications can be used. This vehicle is designed to conform to SAE J1819.

**⚠ WARNING**

■ **When installing a child restraint system**

Observe the following precautions. Failure to do so may result in death or serious injury.

- Firmly attach the top tether strap and make sure that the belt is not twisted.
- Do not attach the top tether strap to anything other than the anchor bracket.
- After securing a child restraint system, never adjust the seat.
- Follow all installation instructions provided by the child restraint system manufacturer.

**WARNING**

- Center rear seat: When installing the child restraint system with the head restraint being raised, after the head restraint has been raised and then the anchor bracket has been fixed, do not lower the head restraint.



## Safety Connect\*

\*: If equipped

**Safety Connect is a subscription-based telematics service that uses Global Positioning System (GPS) data and embedded cellular technology to provide safety and security features to subscribers. Safety Connect is supported by Toyota's designated response center, which operates 24 hours per day, 7 days per week.**

**Safety Connect service is available by subscription on select, telematics hardware-equipped vehicles.**

**By using the Safety Connect service, you are agreeing to be bound by the Telematics Subscription Service Agreement and its Terms and Conditions, as in effect and amended from time to time, a current copy of which is available at [Toyota.com](http://Toyota.com) in the United States, [Toyotapr.com](http://Toyotapr.com) in Puerto Rico and [Toyota.ca](http://Toyota.ca) in Canada. All use of the Safety Connect service is subject to such then-applicable Terms and Conditions.**

## System components

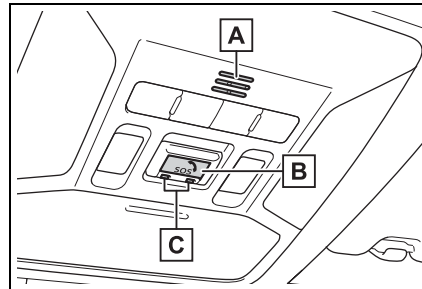

- A** Microphone
- B** "SOS" button
- C** LED light indicators

### ■ Certification for the Safety Connect

FCC ID: BEJTL19BNN  
IC: 2703H-TL19BNN

#### FCC/IC WARNING:

Changes or modifications not expressly approved by the manufacture could void the user's authority to operate the equipment.

This device complies with Part 15 of the FCC Rules and Industry Canada license-exempt RSS standards. Operation is subject to the following two conditions:

- (1) this device may not cause harmful interference, and
- (2) this device must accept any interference, including interference that may cause undesired operation of the device.

This equipment complies with IC RSS-102 radiation exposure limits set forth for uncontrolled environment.

The antennas used for this transmitter must be installed to provide a separation distance of least 20cm from all persons.

#### FCC/IC AVERTISSEMENT:

L'utilisateur est averti que les changements ou modifications non expressément approuvés par le fabricant pourraient annuler l'autorité de l'utilisateur à utiliser l'équipement.

Ce appareil est compatible avec la Partie 15 du règlement FCC et de la Licence de l'industrie canadienne et des normes exemptes de RSS. Opération soumise aux deux conditions suivantes :

- (1) ce appareil ne doit pas causer des interférences nuisibles, et
- (2) cet appareil doit accepté toutes les interférences, y compris les interférences qui peuvent entraîner un fonctionnement indésirable de l'appareil.

Cet appareil est compatible aux limites d'exposition aux radiation IC RSS-102 définies pour un environnement non contrôlé.

Les antennes utilisées pour cet émetteur doivent être installées à une distance d'au moins 20 cm de toutes les personnes.

### Services

Subscribers have the following Safety Connect services available:

- Automatic Collision Notification\*

Helps drivers receive necessary response from emergency service providers. (→P.68)

\*: U.S. Patent No. 7,508,298 B2

- Stolen Vehicle Location

Helps drivers in the event of vehicle theft. (→P.68)

- Emergency Assistance Button

**“SOS”**

Connects drivers to response-center support. (→P.68)

- **Enhanced Roadside Assistance**

Provides drivers various on-road assistance. (→P.69)

### Subscription

After you have signed the Telematics Subscription Service Agreement and are enrolled, you can begin receiving services.

A variety of subscription terms are available for purchase. Contact your Toyota dealer, call the following appropriate Customer Experience Center or push the “SOS” button in your vehicle for further subscription details.

- **The United States**

1-800-331-4331

- **Canada**

1-888-869-6828

- **Puerto Rico**

1-877-855-8377

#### ■ **Safety Connect Services Information**

- Phone calls using the vehicle’s Bluetooth® technology will not be possible when Safety Connect is active and in use.
- Safety Connect is available beginning Fall 2009 on select Toyota models (in the contiguous United States only). Contact with the Safety Connect response center

is dependent upon the telematics device being in operative condition, cellular connection availability, and GPS satellite signal reception, which can limit the ability to reach the response center or receive emergency service support. Enrollment and Telematics Subscription Service Agreement are required. A variety of subscription terms are available; charges vary by subscription term selected and location.

- Automatic Collision Notification, Emergency Assistance and Stolen Vehicle Location are available in the United States, including Hawaii and Alaska, Puerto Rico and Canada, and Enhanced Roadside Assistance are available in the United States, Puerto Rico and Canada.
- Automatic Collision Notification, Emergency Assistance, Stolen Vehicle and Enhanced Road Assistance are not available in the U.S. Virgin Islands. For vehicles first sold in the U.S. Virgin Islands, no Safety Connect services will function in or outside the U.S. Virgin Islands.
- Safety Connect services are not subject to section 255 of the Telecommunications Act and the device is not TTY compatible.

#### ■ **Languages**

The Safety Connect response center will offer support in multiple languages. The Safety Connect system will offer voice prompts in English, Spanish, and French. Please indicate your language of choice when enrolling.

#### ■ **When contacting the response center**

You may be unable to contact the response center if the network is busy.

### Safety Connect LED light Indicators

When the engine switch is turned to ON, the red indicator light comes on for 2 seconds then turns off. Afterward, the green indicator light comes on, indicating that the service is active.

The following indicator light patterns indicate specific system usage conditions:

- Green indicator light on = Active service
- Green indicator light flashing = Safety Connect call in process
- Red indicator light (except at vehicle start-up) = System malfunction (contact your Toyota dealer)
- No indicator light (off) = Safety Connect service not active

### Safety Connect services

#### ■ Automatic Collision Notification

In case of either airbag deployment or severe rear-end collision, the system is designed to automatically call the response center. The responding agent receives the vehicle's location and attempts to speak with the vehicle occupants to assess the

level of emergency. If the occupants are unable to communicate, the agent automatically treats the call as an emergency, contacts the nearest emergency services provider to describe the situation, and requests that assistance be sent to the location.

#### ■ Stolen Vehicle Location

If your vehicle is stolen, Safety Connect can work with local authorities to assist them in locating and recovering the vehicle. After filing a police report, call the Customer Experience Center at 1-800-331-4331 in the United States, 1-877-855-8377 in Puerto Rico or 1-888-869-6828 in Canada, and follow the prompts for Safety Connect to initiate this service.

In addition to assisting law enforcement with recovery of a stolen vehicle, Safety-Connect-equipped vehicle location data may, under certain circumstances, be shared with third parties to locate your vehicle. Further information is available at Toyota.com in the United States, Toyotapr.com in Puerto Rico and Toyota.ca in Canada.

#### ■ Emergency Assistance Button ("SOS")

In the event of an emergency on the road, push the "SOS" button to reach the Safety Connect response center. The answer-

ing agent will determine your vehicle's location, assess the emergency, and dispatch the necessary assistance required.

If you accidentally press the "SOS" button, tell the response-center agent that you are not experiencing an emergency.

#### ■ **Enhanced Roadside Assistance**

Enhanced Roadside Assistance adds GPS data to the already included warranty-based Toyota roadside service.

Subscribers can press the "SOS" button to reach a Safety Connect response-center agent, who can help with a wide range of needs, such as: towing, flat tire, fuel delivery, etc. For a description of the Enhanced Roadside Assistance services and their limitations, please see the Safety Connect Terms and Conditions, which are available at [Toyota.com](http://Toyota.com) in the United States, [Toyotapr.com](http://Toyotapr.com) in Puerto Rico and [Toyota.ca](http://Toyota.ca) in Canada.

#### **Safety information for Safety Connect**

Important! Read this information before using Safety Connect.

#### ■ **Exposure to radio frequency signals**

The Safety Connect system installed in your vehicle is a low-

power radio transmitter and receiver. It receives and also sends out radio frequency (RF) signals.

In August 1996, the Federal Communications Commission (FCC) adopted RF exposure guidelines with safety levels for mobile wireless phones. Those guidelines are consistent with the safety standards previously set by the following U.S. and international standards bodies.

- ANSI (American National Standards Institute) C95.1 [1992]
- NCRP (National Council on Radiation Protection and Measurement) Report 86 [1986]
- ICNIRP (International Commission on Non-Ionizing Radiation Protection) [1996]

Those standards were based on comprehensive and periodic evaluations of the relevant scientific literature. Over 120 scientists, engineers, and physicians from universities, and government health agencies and industries reviewed the available body of research to develop the ANSI Standard (C95.1).

The design of Safety Connect complies with the FCC guidelines in addition to those standards.

### Engine immobilizer system

**The vehicle's keys have built-in transponder chips that prevent the engine from starting if a key has not been previously registered in the vehicle's on-board computer.**

**Never leave the keys inside the vehicle when you leave the vehicle.**

This system is designed to help prevent vehicle theft but does not guarantee absolute security against all vehicle thefts.

#### Operating the system

- ▶ Vehicles without smart key system

The indicator light flashes after the key has been removed from the engine switch to indicate that the system is operating. The indicator light stops flashing after the registered key has been inserted into the engine switch to indicate that the system has been canceled.

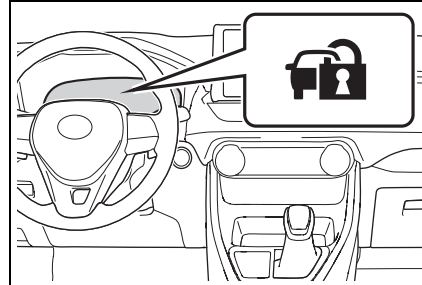

- ▶ Vehicles with smart key system

The indicator light flashes after the engine switch has been turned to OFF to indicate that the system is operating.

The indicator light stops flashing after the engine switch has been turned to ACC or ON to indicate that the system has been canceled.

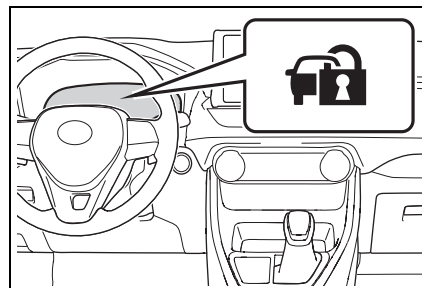

#### ■ System maintenance

The vehicle has a maintenance-free type engine immobilizer system.

#### ■ Conditions that may cause the system to malfunction

- If the grip portion of the key is in contact with a metallic object
- If the key is in close proximity to or touching a key to the security system (key with a built-in transponder chip) of another vehicle

**■ Certification for the engine immobilizer system**

- For vehicles sold in the U.S.A., Hawaii, American Samoa, Guam, Saipan and Puerto Rico

FCC ID : MOZRI-57BTY

This device complies with part 15 of the FCC Rules. Operation is subject to the following two conditions: (1) This device may not cause harmful interference, and (2) this device must accept any interference received, including interference that may cause undesired operation.

Changes or modifications not expressly approved by the party responsible for compliance could void the user's authority to operate the equipment.

FCC ID : NI4TMIMB-3

This device complies with part 15 of the FCC Rules. Operation is subject to the following two conditions: (1) This device may not cause harmful interference, and (2) this device must accept any interference received, including interference that may cause undesired operation.

Changes or modifications not expressly approved by the party responsible for compliance could void the user's authority to operate the equipment.

- For vehicles sold in Canada

This device complies with Industry Canada's licence-exempt RSSs. Operation is subject to the following two conditions: (1) This device may not cause interference; and (2) This device must accept any interference, including interference that may cause undesired operation of the device.

Le présent appareil est conforme aux CNR d'Industrie Canada applicables aux appareils radio exempts de licence. L'exploitation est autorisée aux deux conditions suivantes : 1) l'appareil ne doit pas produire de brouillage; 2) l'utilisateur de l'appareil doit accepter tout brouillage radioélectrique subi, même si le brouillage est susceptible d'en compromettre le fonctionnement.

This device complies with Industry Canada's licence-exempt RSSs. Operation is subject to the following two conditions: (1) This device may not cause interference; and (2) This device must accept any interference, including interference that may cause undesired operation of the device.

Le présent appareil est conforme aux CNR d'Industrie Canada applicables aux appareils radio exempts de licence. L'exploitation est autorisée aux deux conditions suivantes : 1) l'appareil ne doit pas produire de brouillage; 2) l'utilisateur de l'appareil doit accepter tout brouillage radioélectrique subi, même si le brouillage est susceptible d'en compromettre le fonctionnement.

**NOTICE****■ To ensure the system operates correctly**

Do not modify or remove the system. If modified or removed, the proper operation of the system cannot be guaranteed.



## Alarm\*

\*: If equipped

**The alarm uses light and sound to give an alert when an intrusion is detected.**

**The alarm is triggered in the following situations when the alarm is set:**

- Vehicles without smart key system: A locked door is unlocked or opened in any way other than using the wireless remote control or key. (The doors will lock again automatically.)
- Vehicles with smart key system: A locked door is unlocked or opened in any way other than using the entry function, wireless remote control or mechanical key. (The doors will lock again automatically.)
- The hood is opened.

### Setting/canceling/stopping the alarm system

#### ■ Items to check before locking the vehicle

To prevent unexpected triggering of the alarm and vehicle theft, make sure of the following:

- Nobody is in the vehicle.
- The side windows and moon roof (if equipped) or pan-

oramic moon roof (if equipped) are closed before the alarm is set.

- No valuables or other personal items are left in the vehicle.

#### ■ Setting

Close the doors and hood, and lock all the doors. The system will be set automatically after 30 seconds.

The security indicator changes from being on to flashing when the system is set.

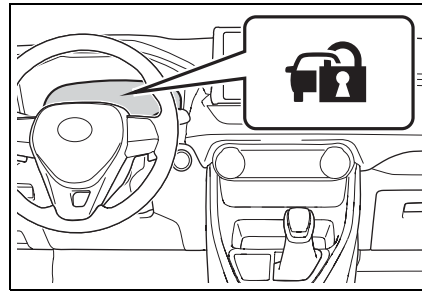

#### ■ Canceling or stopping

Do one of the following to deactivate or stop the alarm:

- Unlock the doors.
- Turn the engine switch to ACC or ON, or start the engine. (The alarm will be deactivated or stopped after a few seconds.)

#### ■ System maintenance

The vehicle has a maintenance-free type alarm system.

#### ■ Triggering of the alarm

The alarm may be triggered in the following situations:

(Stopping the alarm deactivates the alarm system.)

- A person inside the vehicle opens a door or hood, or unlocks the vehicle using an inside lock button.

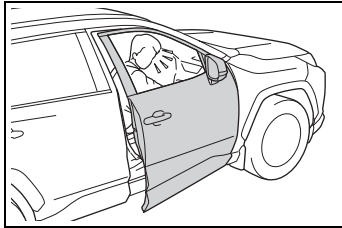

- The battery is recharged or replaced when the vehicle is locked. (→P.655)

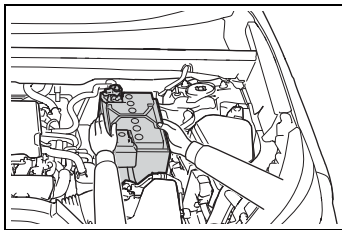

■ **Alarm-operated door lock**

In the following cases, depending on the situation, the door may automatically lock to prevent improper entry into the vehicle:

- When a person remaining in the vehicle unlocks the door and the alarm is activated.
- While the alarm is activated, a person remaining in the vehicle unlocks the door.
- When recharging or replacing the battery.



**NOTICE**

■ **To ensure the system operates correctly**

Do not modify or remove the system. If modified or removed, the proper operation of the system cannot be guaranteed.

**Vehicle status information and indicators**

**2**

75

**2-1. Instrument cluster**

- Warning lights and indicators ..... 76
- Gauges and meters (with 4.2-inch display) ..... 82
- Gauges and meters (with 7-inch display) ..... 85
- Multi-information display 89
- Fuel consumption information ..... 99

**2**

Vehicle status information and indicators

## Warning lights and indicators

The warning lights and indicators on the instrument cluster, center panel and outside rear view mirrors inform the driver of the status of the vehicle's various systems.

### Instrument cluster

For the purpose of explanation, the following illustrations display all warning lights and indicators illuminated.

#### ■ With 4.2-inch display

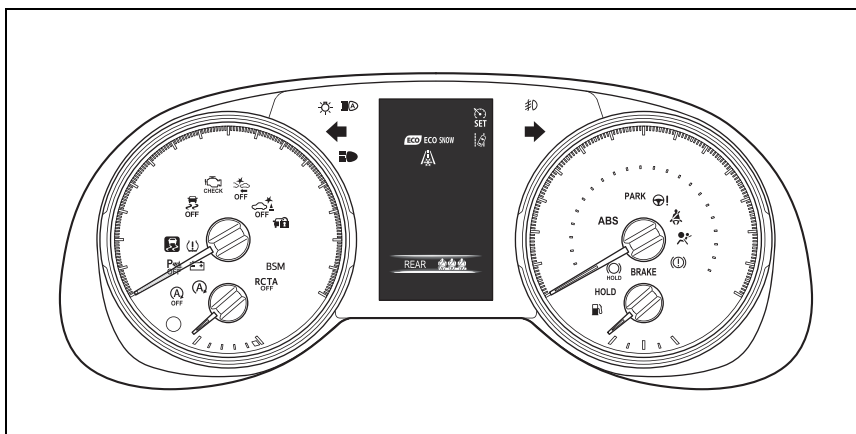

The units used on the meters and some indicators may differ depending on the target region.

#### ■ With 7-inch display

The display of the speedometer can be selected from two types, analog or digital. (→P.94)

- ▶ When analog speedometer is displayed

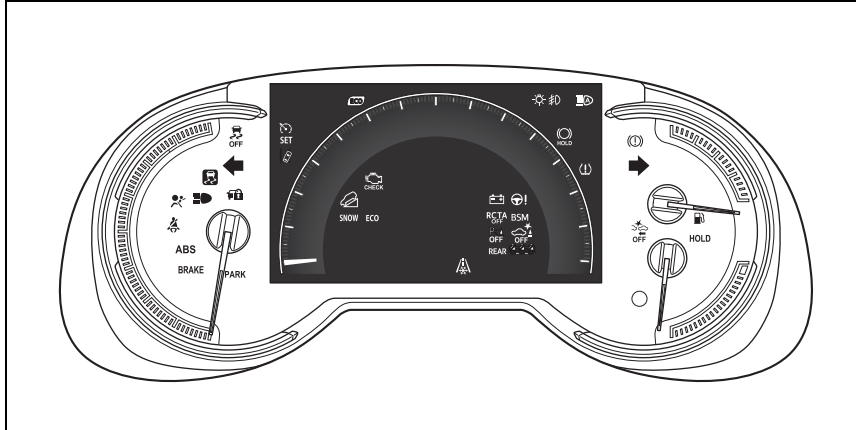

The units used on the meters and some indicators may differ depending on the target region.

- ▶ When digital speedometer is displayed

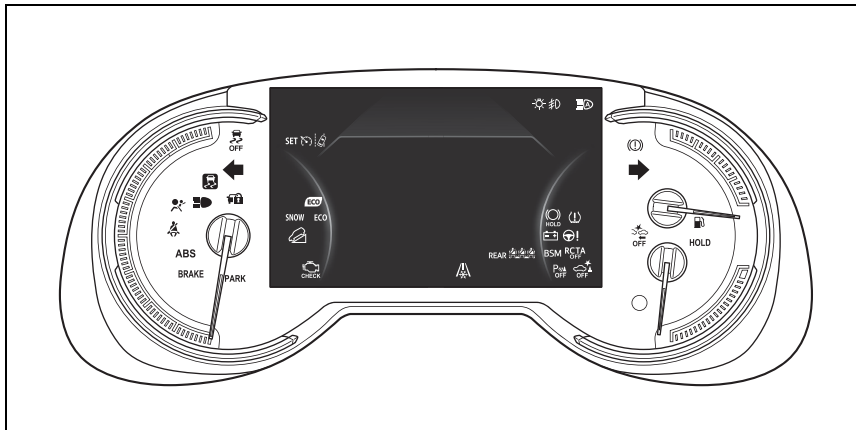

The units used on the meters and some indicators may differ depending on the target region.

### Warning lights

























Warning lights inform the driver of malfunctions in the indicated vehicle's systems.



Brake system warning light\*<sup>1</sup> (→P.628)



Brake system warning light\*<sup>1</sup> (→P.628)

 (Yellow)	Brake system warning light* <sup>1</sup> (→P.628)	 (Flashes)	Intuitive parking assist OFF indicator* <sup>3</sup> (if equipped) (→P.631)
	Charging system warning light* <sup>1</sup> (→P.628)	 OFF	PKSB OFF indicator* <sup>1</sup> (if equipped) (→P.632)
	High coolant temperature warning light* <sup>2</sup> (→P.629)	 (Flashes)	RCTA OFF indicator* <sup>1</sup> (if equipped) (→P.632)
	Low engine oil pressure warning light* <sup>2</sup> (→P.629)		Slip indicator light* <sup>1</sup> (→P.632)
 (U.S.A.)	Malfunction indicator lamp* <sup>1</sup> (→P.629)		Brake Override System/Drive-Start Control/PKSB (if equipped) warning light* <sup>2</sup> (→P.633)
 (Canada)	Malfunction indicator lamp* <sup>1</sup> (→P.629)	 (Flashes)	Brake hold operated indicator* <sup>1</sup> (→P.633)
	SRS warning light* <sup>1</sup> (→P.629)	 (U.S.A.) (Flashes)	Parking brake indicator (→P.634)
 (U.S.A.)	ABS warning light* <sup>1</sup> (→P.630)	 (Canada) (Flashes)	Parking brake indicator (→P.634)
 (Canada)	ABS warning light* <sup>1</sup> (→P.630)		Tire pressure warning light* <sup>1</sup> (if equipped) (→P.634)
 (Red/yellow)	Electric power steering system warning light* <sup>1</sup> (→P.630)		Low fuel level warning light (→P.634)
 (Flashes or illuminates)	PCS warning light* <sup>1</sup> (→P.630)		Driver's and front passenger's seat belt reminder light (→P.635)
 (Orange)	LTA indicator (→P.631)		Rear passengers' seat belt reminder light (if equipped) (→P.635)
 (Flashes)	Stop & Start cancel indicator* <sup>1</sup> (if equipped) (→P.631)		

\*1: These lights turn on when the engine switch is turned to ON to

indicate that a system check is being performed. They will turn off after the engine is started, or after a few seconds. There may be a malfunction in a system if the light does not come on, or turn off. Have the vehicle inspected by your Toyota dealer.

- \*2: This light illuminates on the multi-information display with a message.
- \*3: Intuitive parking assist OFF indicator turns on when the engine switch is turned to ON while the Intuitive parking assist function is on. It will turn off after a few seconds.

**⚠ WARNING**

■ **If a safety system warning light does not come on**

Should a safety system light such as the ABS and SRS warning light not come on when you start the engine, this could mean that these systems are not available to help protect you in an accident, which could result in death or serious injury. Have the vehicle inspected by your Toyota dealer immediately if this occurs.

### Indicators

The indicators inform the driver of the operating state of the vehicle's various systems.



Turn signal indicator (→P.202)



Headlight indicator (→P.209)



Tail light indicator (→P.209)



Headlight high beam indicator (→P.211)



Automatic High Beam indicator (→P.212)



Fog light indicator (if equipped) (→P.437)



Smart key system indicator\*<sup>1</sup> (if equipped) (→P.194)



Cruise control indicator (→P.250)



Dynamic radar cruise control indicator (→P.250)



Cruise control "SET" indicator (→P.250)

























LTA indicator\*<sup>2</sup> (→P.242)



Intuitive parking assist OFF indicator\*<sup>3, 4</sup> (if equipped) (→P.271)



PKSB OFF indicator\*<sup>3, 5</sup> (if equipped) (→P.278)

 (Flashes)	Slip indicator light <sup>*5</sup> (→P.361)		Sport mode indicator (→P.351)
	VSC OFF indicator <sup>*3, 5</sup> (→P.362)		Mud & sand mode indicator (if equipped) (→P.354)
	PCS warning light <sup>*3, 5</sup> (→P.231)		Rock & dirt mode indi- cator (if equipped) (→P.354)
	BSM outside rear view mirror indicators <sup>*5, 6</sup> (if equipped) (→P.261)		Snow mode indicator (if equipped) (→P.357)
	BSM indicator (if equipped) (→P.261)		Downhill assist control system indicator <sup>*5</sup> (if equipped) (→P.358)
	RCTA OFF indicator <sup>*3, 5</sup> (if equipped) (→P.261)		"AIR BAG ON/OFF" indicator <sup>*5, 8</sup> (→P.43)
	Stop & Start indica- tor <sup>*5</sup> (if equipped) (→P.345)		<sup>*1</sup> : This light illuminates on the multi-information display with a message.
	Stop & Start cancel indicator <sup>*3, 5</sup> (if equipped) (→P.346)		<sup>*2</sup> : Depending on the operating con- ditions of the system, the color and state (illuminated/blinking) of the indicator change.
	Brake hold standby indicator <sup>*5</sup> (→P.206)		<sup>*3</sup> : The light comes on when the system is turned off.
	Brake hold operated indicator <sup>*5</sup> (→P.206)		<sup>*4</sup> : Intuitive parking assist OFF indi- cator turns on when the engine switch is turned to ON while the Intuitive parking assist function is on. It will turn off after a few sec- onds.
	Security indicator (→P.70, 73)		<sup>*5</sup> : These lights turn on when the engine switch is turned to ON to indicate that a system check is being performed. They will turn off after the engine is started, or after a few seconds. There may be a malfunction in a system if the lights do not turn on, or turn off. Have the vehicle inspected by your Toyota dealer.
	Low outside tempera- ture indicator <sup>*7</sup> (→P.83, 87)		<sup>*6</sup> : This light illuminates on the out-
	Eco Driving Indicator Light <sup>*5</sup> (→P.92)		
	Parking brake indica- tor (→P.203) (U.S.A.)		
	Parking brake indica- tor (→P.203) (Canada)		
	Eco drive mode indi- cator (→P.351)		



side rear view mirrors.



\*7: When the outside temperature is approximately 37°F (3°C) or lower, the indicator will flash for approximately 10 seconds, then stay on.

\*8: This light illuminates on the center panel.

---

#### ■ BSM (Blind Spot Monitor) outside rear view mirror indicators (if equipped)

In order to confirm operation, the BSM outside rear view mirror indicators illuminate in the following situations:

- When the engine switch is turned to ON while the BSM function is enabled on the  screen of the multi-information display.
- When the BSM function is enabled on the  screen of the multi-information display while the engine switch is in ON.

If the system is functioning correctly, the BSM outside rear view mirror indicators will turn off after a few seconds.

If the BSM outside rear view mirror indicators do not illuminate or do not turn off, there may be a malfunction in the system. If this occurs, have the vehicle inspected by your Toyota dealer.

Gauges and meters (with 4.2-inch display)

The meters display various drive information.

Meter display

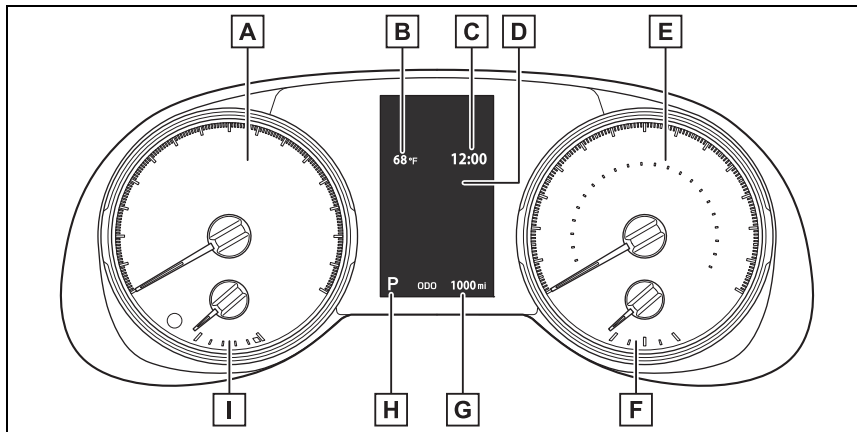

The units used on the meter and display may differ depending on the target region.

- A** Tachometer  
Displays the engine speed in revolutions per minute
- B** Outside temperature (→P.83)
- C** Clock (→P.84)
- D** Multi-information display  
Presents the driver with a variety of driving-related data (→P.89)  
Displays warning messages if a malfunction occurs (→P.639)
- E** Speedometer  
Displays the vehicle speed
- F** Fuel gauge  
Displays the quantity of fuel remaining in the tank
- G** Odometer and trip meter  
Odometer:  
Displays the total distance that the vehicle has been driven  
Trip meter:  
Displays the distance the vehicle has been driven since the meter was last

reset. Trip meters “A” and “B” can be used to record and display different distances independently.

**H** Shift position and shift range indicator

Displays the selected shift position or selected shift range (→P.199)

**I** Engine coolant temperature gauge

Displays the engine coolant temperature

**■ The meters and display illuminate when**

The engine switch is in ON.

**■ Outside temperature display**

- In the following situations, the correct outside temperature may not be displayed, or the display may take longer than normal to change.
  - When stopped, or driving at low speeds (less than 12 mph [20 km/h])
  - When the outside temperature has changed suddenly (at the entrance/exit of a garage, tunnel, etc.)
- When “--” or “E” is displayed, the system may be malfunctioning. Take your vehicle to your Toyota dealer.
- Displays the outside temperature within the range of -40°F (-40°C) to 122°F (50°C).
- When the outside temperature is approximately 37°F (3°C) or lower, the indicator  will flash for approximately 10 seconds, then stay on.

**■ Liquid crystal display**

→P.90

**⚠ WARNING**

**■ The information display at low temperatures**

Allow the interior of the vehicle to warm up before using the liquid crystal information display. At extremely low temperatures, the display monitor may respond slowly, and display changes may be delayed.

For example, there is a lag between the driver's shifting and the new gear number appearing on the display. This lag could cause the driver to downshift again, causing rapid and excessive engine braking and possibly an accident resulting in death or injury.

**⚠ NOTICE**

**■ To prevent damage to the engine and its components**

- Do not let the indicator needle of the tachometer enter the red zone, which indicates the maximum engine speed.
- The engine may be overheating if the engine coolant temperature gauge is in the red zone (“H”). In this case, immediately stop the vehicle in a safe place, and check the engine after it has cooled completely. (→P.659)

**Using the “ODO TRIP” switch**

Switches the items of the odometer, trip meter A and trip meter B by pressing the “ODO TRIP” switch.

When the trip meter is displayed, pressing and holding the switch will reset the trip meter.

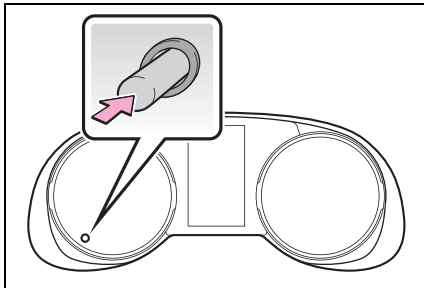

**Instrument panel light control**

The brightness of the instrument panel lights can be adjusted by turning the dial.

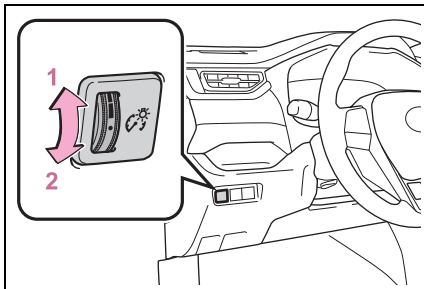

- 1 Brighter
- 2 Darker

**Instrument cluster brightness adjustment**

The instrument cluster brightness

levels when the tail lights are on and off can be adjusted individually. However, when the surroundings are bright (daytime, etc.), turning on the tail lights will not change the instrument cluster brightness.

**Adjusting the clock**

The clocks can be adjusted on the audio system screen.

- ▶ Vehicles with Audio  
→P.415
- ▶ Vehicles with Audio Plus or Premium Audio

Refer to “NAVIGATION AND MULTIMEDIA SYSTEM OWNER’S MANUAL”.

## Gauges and meters (with 7-inch display)

The meters display various drive information.

### Meter display

The display of the speedometer can be selected from two types, analog or digital. (→P.94)

#### ► Analog speedometer

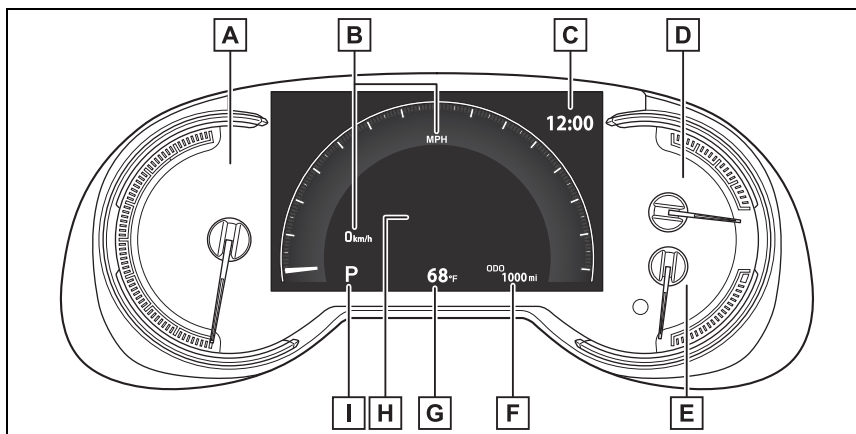

The units used on the meter and display may differ depending on the target region.

#### **A** Tachometer

Displays the engine speed in revolutions per minute

#### **B** Speedometer

Displays the vehicle speed

#### **C** Clock (→P.88)

#### **D** Fuel gauge

Displays the quantity of fuel remaining in the tank

#### **E** Engine coolant temperature gauge

Displays the engine coolant temperature

#### **F** Odometer and trip meter

Odometer:

Displays the total distance that the vehicle has been driven

Trip meter:

Displays the distance the vehicle has been driven since the meter was last reset. Trip meters “A” and “B” can be used to record and display different distances independently.

**G** Outside temperature (→P.87)

**H** Multi-information display

Presents the driver with a variety of driving-related data (→P.89)

Displays warning messages if a malfunction occurs (→P.639)

**I** Shift position and shift range indicator

Displays the selected shift position or selected shift range (→P.199)

► Digital speedometer

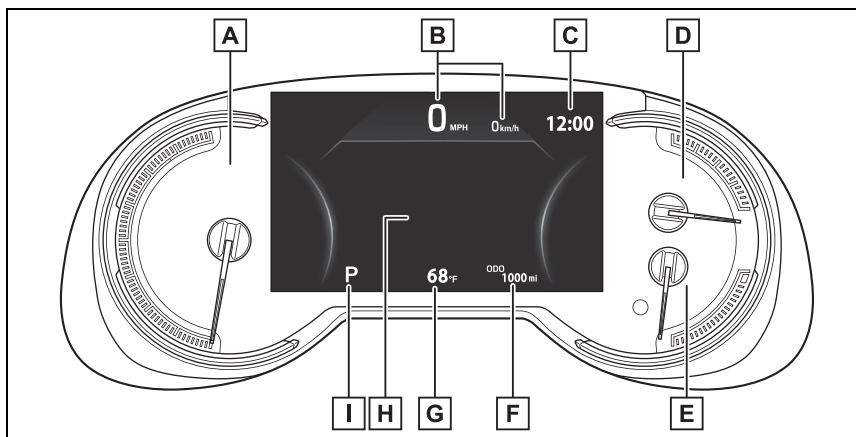

The units used on the meter and display may differ depending on the target region.

**A** Tachometer

Displays the engine speed in revolutions per minute

**B** Speedometer

Displays the vehicle speed

**C** Clock (→P.88)

**D** Fuel gauge

Displays the quantity of fuel remaining in the tank

**E** Engine coolant temperature gauge

Displays the engine coolant temperature

**F** Odometer and trip meter

Odometer:

Displays the total distance that the vehicle has been driven

Trip meter:

Displays the distance the vehicle has been driven since the meter was last reset. Trip meters “A” and “B” can be used to record and display different distances independently.

**G** Outside temperature (→P.83)

**H** Multi-information display

Presents the driver with a variety of driving-related data (→P.89)

Displays warning messages if a malfunction occurs (→P.639)

**I** Shift position and shift range indicator

Displays the selected shift position or selected shift range (→P.199)

#### ■ The meters and display illuminate when

The engine switch is in ON.

#### ■ When changing driving mode

- Speedometer color is changed following the selected driving mode. (→P.351)
- AWD models: Speedometer color is changed following the selected driving mode or Multi-terrain Select mode. (→P.351, 353)

#### ■ Outside temperature display

- In the following situations, the correct outside temperature may not be displayed, or the display may take longer than normal to change.
  - When stopped, or driving at low speeds (less than 12 mph [20 km/h])
  - When the outside temperature has changed suddenly (at the entrance/exit of a garage, tunnel, etc.)
- When “--” or “E” is displayed, the system may be malfunctioning. Take your vehicle to your Toyota dealer.
- Displays the outside temperature within the range of -40°F (-40°C) to 122°F (50°C).
- When the outside temperature is approximately 37°F (3°C) or lower, the indicator  will flash

for approximately 10 seconds, then stay on.

#### ■ Liquid crystal display

→P.90

#### ■ Customization

Settings (e. g. meter display) can be changed on the  screen of the multi-information display. (→P.94)

#### WARNING

##### ■ The information display at low temperatures

Allow the interior of the vehicle to warm up before using the liquid crystal information display. At extremely low temperatures, the display monitor may respond slowly, and display changes may be delayed.

For example, there is a lag between the driver's shifting and the new gear number appearing on the display. This lag could cause the driver to downshift again, causing rapid and excessive engine braking and possibly an accident resulting in death or injury.

 NOTICE

■ **To prevent damage to the engine and its components**

- Do not let the indicator needle of the tachometer enter the red zone, which indicates the maximum engine speed.
- The engine may be overheating if the engine coolant temperature gauge is in the red zone ("H"). In this case, immediately stop the vehicle in a safe place, and check the engine after it has cooled completely. (→P.659)

**Using the "ODO TRIP" switch**

Switches the items of the odometer, trip meter A and trip meter B by pressing the "ODO TRIP" switch.

When the trip meter is displayed, pressing and holding the switch will reset the trip meter.

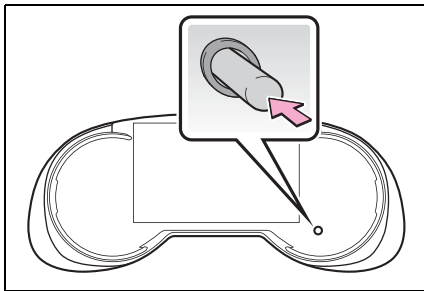

**Instrument panel light control**

The brightness of the instrument panel lights can be adjusted by turning the dial.

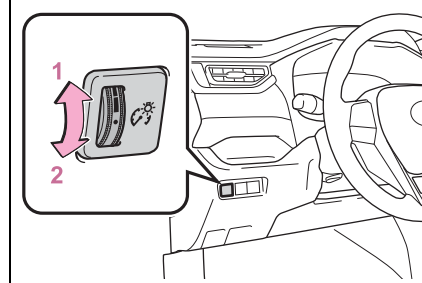

- 1 Brighter
- 2 Darker

■ **Instrument cluster brightness adjustment**

The instrument cluster brightness levels when the tail lights are on and off can be adjusted individually. However, when the surroundings are bright (daytime, etc.), turning on the tail lights will not change the instrument cluster brightness.

**Adjusting the clock**

The clocks can be adjusted on the audio system screen.

- ▶ Vehicles with Audio

→P.415

- ▶ Vehicles with Audio Plus or Premium Audio

Refer to "NAVIGATION AND MULTIMEDIA SYSTEM OWNER'S MANUAL".



Multi-information display

The multi-information display is used to display fuel efficiency related information and various types of driving-related information. The multi-information display can also be used to change the display settings and other settings.

Display contents

Following information is displayed on the multi-information display.

■ Vehicles with 4.2-inch display

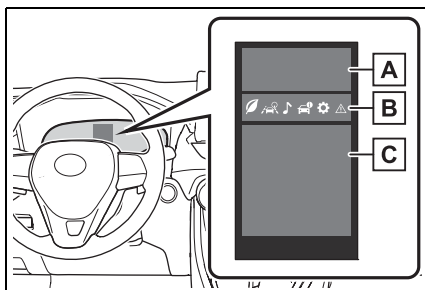

A Driving support system information

Displays recognized signs while the RSA system (if equipped) is operating. (→P.247)

Displays an image when the following systems are operating and a menu icon other than  is selected:

- LTA (Lane Tracing Assist)

(→P.237)

- Dynamic radar cruise control with full-speed range (→P.250)

B Menu icons (→P.90)

C Information display area

A variety of information can be displayed by selecting a menu icon.

Additionally, warning or suggestion/advice pop-up displays will be displayed in some situations.

■ Vehicles with 7-inch display

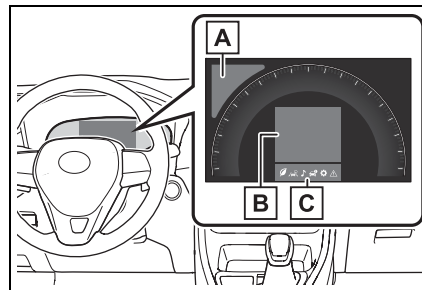

A Driving support system information

Displays recognized signs while the RSA system (if equipped) is operating. (→P.247)

Displays an image when the following systems are operating and a menu icon other than  is selected:

- LTA (Lane Tracing Assist) (→P.237)
- Dynamic radar cruise control with full-speed range (→P.250)

B Information display area

A variety of information can be displayed by selecting a menu icon.

Additionally, warning or suggestion/advice pop-up displays will be displayed in some situations.

C Menu icons (→P.90)

### ■ The multi-information display is displayed when

The engine switch is in ON.

### ■ When changing driving mode

- Background color of the multi-information display is changed following the selected driving mode. (→P.351)
- AWD models: Background color of the multi-information display is changed following the selected driving mode or Multi-terrain Select mode. (→P.351, 353)

### ■ Liquid crystal display

Small spots or light spots may appear on the display. This phenomenon is characteristic of liquid crystal displays, and there is no problem continuing to use the display.

## Changing the display

The multi-information display is operated using the meter control switches.

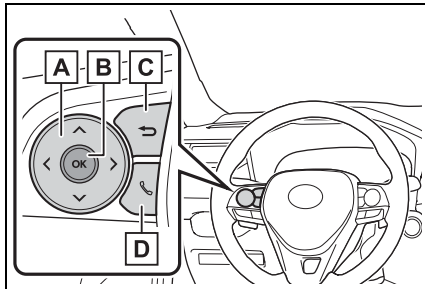

- A** Scroll the screen\*/switch the display\*/move the cursor
- B** Press: Enter/Set  
Press and hold: Reset/Display customizable items
- C** Return to the previous screen
- D** Call sending/receiving and

history display (if equipped)  
Linked with the hands-free system, sending or receiving call is displayed. For details regarding the hands-free system, refer to P.465 (vehicles with Audio) or "NAVIGATION AND MULTIMEDIA SYSTEM OWNER'S MANUAL" (vehicles with Audio Plus or Premium Audio).

- \*: On screens where the screen can be scrolled and the display can be switched, a scroll bar or a round icon that shows the number of registered screens is displayed.

### ⚠ WARNING







#### ■ Caution for use while driving

For safety, avoid operating the meter control switch while driving as much as possible, and do not look continuously at the multi-information display while driving. Stop the vehicle and operate the meter control switch. Failure to do so may cause a steering wheel operation error, resulting in an unexpected accident.

## Menu icons

Information related to each icon can be displayed by selecting the icon with the meter control switches.

Some of the information may be displayed automatically depending on the situation.

Icon	Display
	Driving information display (→P.91)
	Driving support system information display (→P.93)
	Audio system-linked display (if equipped) (→P.93)
	Vehicle information display (→P.93)
	Settings display (→P.94)
	Warning message display (→P.98)

### Driving information display

Select to display fuel consumption data in various forms.

#### ■ Speedometer display/Distance to empty (4.2-inch display)

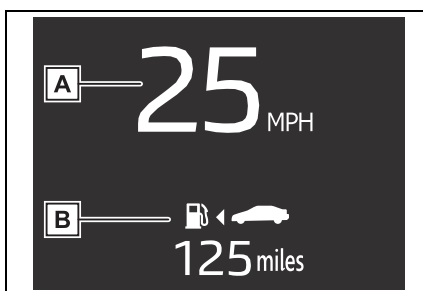

**A** Speedometer display  
Displays the vehicle speed.

**B** Distance to empty  
Displays the driving range with

remaining fuel. (→P.92)

#### ■ Fuel Economy

Following information is displayed.

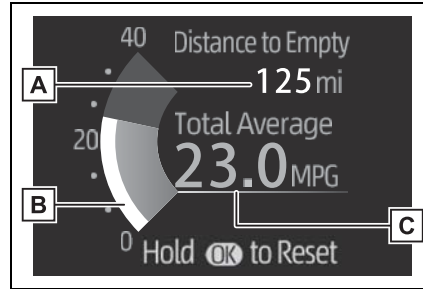

**A** Distance to empty  
Displays the driving range with remaining fuel. (→P.92)

**B** Current fuel economy  
Displays the instantaneous current fuel Economy.

**C** Average fuel economy  
Displays the average fuel economy since the function was reset or the average fuel economy after starting or refueling. \*1, 2,3

The average fuel economy selected by “Fuel Economy” on the  screen is displayed. (→P.94)

\*1: Use the displayed fuel consumption as a reference only.

\*2: Average fuel economy since the function was reset can be reset by pressing and holding .

\*3: Average fuel economy after starting is reset each time the engine stops.

2

Vehicle status information and indicators

### ■ Eco Driving Indicator/Distance to empty

#### ► Display contents

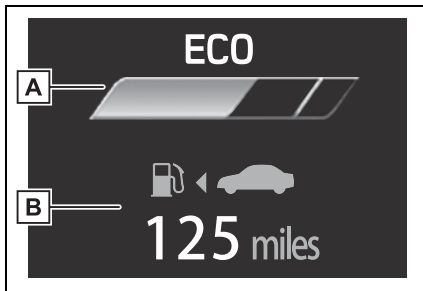

**A** Eco Driving Indicator

**B** Distance to empty

Displays the driving range with remaining fuel. (→P.92)

#### ► Eco Driving Indicator

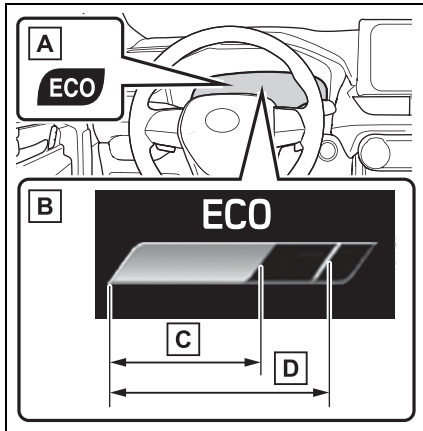

**A** Eco Driving Indicator Light

During Eco-friendly acceleration operation (Eco driving), the Eco Driving Indicator Light will turn on. When the acceleration exceeds Zone of Eco driving, or when the vehicle is stopped, the light turns off.

**B** Eco Driving Indicator Zone

#### Display

Suggests the Zone of Eco driving with current Eco driving ratio based on acceleration.

**C** Eco driving ratio based on acceleration

If the acceleration exceeds Zone of Eco driving, the right side of Eco Driving Indicator Zone Display will illuminate.

At this time, the Eco Driving Indicator Light will turn off.

**D** Zone of Eco driving

### ■ Distance to empty

- This distance is computed based on your average fuel consumption. As a result, the actual distance that can be driven may differ from that displayed.
- When only a small amount of fuel is added to the tank, the display may not be updated. When refueling, turn the engine switch off. If the vehicle is refueled without turning the engine switch off, the display may not be updated.
- When "Refuel" is displayed, the remaining fuel amount is low and the distance that can be driven with the remaining fuel cannot be calculated. Refuel immediately.

### ■ The ECO Driving indicator will not operate when

Eco Driving Indicator will not operate in the following conditions:

- The shift lever is in any position other than D.
- Neither normal mode nor Eco drive mode is selected.
- The vehicle speed is approximately 80 mph (130 km/h) or higher.

### Driving support system information display

#### ■ Driving support system information display

Select to display the operational status of the following systems:

- LTA (Lane Tracing Assist) (→P.237)
- Dynamic radar cruise control with full-speed range (→P.250)

#### ■ Navigation system-linked display (if equipped)

Select to display the following navigation system-linked information.

- Route guidance
- Compass display (north-up display/heading-up display)

### Audio system-linked display (if equipped)

Select to enable selection of an audio source or track on the display.

### Vehicle information display

#### ■ Drive information

2 items that are selected using the “Drive Info Items” setting (average speed, distance and total time) can be displayed vertically.

The displayed information

changes according to the “Drive Info Type” setting (since the system was started or between resets). (→P.94)

Use the displayed information as a reference only.

Following items will be displayed.

- “Trip”
  - “Average Speed”: Displays the average vehicle speed since engine start\*
  - “Distance”: Displays the distance driven since engine start\*
  - “Total Time”: Displays the elapsed time since engine start\*
- \*: These items are reset each time the engine stops.

- “Total”
  - “Average Speed”: Displays the average vehicle speed since the display was reset\*
  - “Distance”: Displays the distance driven since the display was reset\*
  - “Total Time”: Displays the elapsed time since the display was reset\*
- \*: To reset, display the desired item and press and hold .

### ■ AWD system display (AWD models)

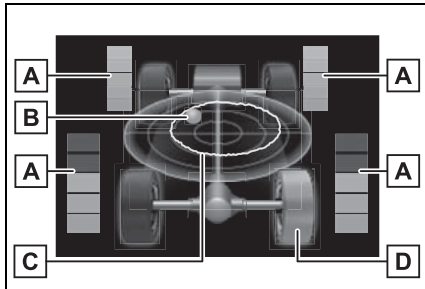

#### A Torque distribution display

Displays the drive status of each wheel in 6 steps from 0 to 5.

#### B G-force display \*

Displays the size and direction of the G-force applied to the vehicle via changes to the position of the ball on the display.

#### C Maximum G-force course \*

This item is linked with the G-force display and the course of the past movement of the ball is displayed.

Press and hold  to reset the record.

#### D Wheel spin display









When a tire is spinning, its icon on the display changes its color and blinks.

\*: This item is displayed only when driving mode is set to sport mode.

### Settings display

Vehicle settings and the content displayed on the screen can be changed by using the meter control switches.

### ■ Setting procedure

- Operate  or  of the meter control switches and select .
- Operate  or  of the meter control switches and select the desired item.
  - If the function is turned on and off or the volume, etc. is changed on the setting screen, the setting is changed each time  is pressed.
  - For functions that allow operation contents, display contents, etc., of function to be selected, the setting screen is displayed by pressing and holding . When the setting screen is displayed, select the setting or desired value (time, etc.) with .
- After changing the settings, press  of the meter control switches.

### ■ LTA (Lane Tracing Assist) (→P.237)

Select to set up the following items.

#### ● “Lane Center”

Select to enable/disable the lane centering function.

#### ● “Steering Assist”

Select to enable/disable steering wheel assistance.

#### ● “Sensitivity”

Select to set the lane departure alert sensitivity.

- “Sway Warning”

Select to enable/disable the vehicle sway warning.

- “Sway Sensitivity”

Select to set the vehicle sway warning sensitivity.

#### ■ **PCS (Pre-Collision System) (→P.229)**

Select to set up the following items.

- PCS on/off

Select to enable/disable the pre-collision system.

- “Sensitivity”

Select to change the pre-collision warning timing.

#### ■ **BSM (Blind Spot Monitor) (if equipped) (→P.260)**

Select to set up the following items.

- BSM (Blind Spot Monitor) on/off

Select to enable/disable the BSM system.

- “Brightness”

Select to switch the brightness of the outside rear view mirror indicators. (→P.261)

- “Sensitivity”

Select to change the alert timing for an approaching vehicle.

#### ■ **(Intuitive parking assist) (if equipped) (→P.270)**

Select to set up the following items.

- Intuitive parking assist on/off

Select to enable/disable the Intuitive parking assist.

- “Volume”

Select to set the volume of the buzzer which sounds when the Intuitive parking assist is operated.

#### ■ **RCTA (Rear Cross Traffic Alert) (if equipped) (→P.260)**

- RCTA (Rear Cross Traffic Alert) on/off

Select to enable/disable the RCTA system.

- “Volume”

Select to change the RCTA buzzer volume.

#### ■ **PKSB (Parking Support Brake System) (if equipped) (→P.277)**

Select to enable/disable the Parking Support Brake function.

#### ■ **RSA (Road Sign Assist) (if equipped) (→P.247)**

Select to set up the following items.

- Road Sign Assist on/off

Select to enable/disable the RSA system.

- “Notification method”

Select to change each notification method used to warn the driver when the system recognizes excess speed, no overtaking and no-entry sign.

- “Notification Level”

Select to change each notification level used to warn the driver when the system recognizes a speed limit sign.

### ■ Vehicle Settings

-  PBD (Power Back Door) (if equipped) (→P.118)

Select to set up the following items.

- System settings

Select to enable/disable the power back door system.

- “Kick Sensor”\*

Select to enable/disable the kick sensor.

- “Opening Adjustment”

Select the open position when power back door is fully open.

- “Volume”

Select to set the volume of the buzzer which sounds when the power back door system operates.

\*: Vehicles with hands free power back door

-  (Stop & Start system) (if equipped) (→P.345)

Select to set the length of time the Stop & Start system will operate when the “A/C” switch of the air conditioning system is on.

- “TPWS” (Tire Pressure Warning System) (if equipped)

(→P.584)

- “Set Pressure”

Select to initialize the tire pressure warning system.

- “Change Wheel” (except for models made in Japan\* without tire inflation pressure display function)

Select to register the ID codes of the tire pressure sensors to the tire pressure warning system.

- “Change Wheel” (for models made in Japan\* without tire inflation pressure display function)

Select to change the tire pressure warning system sensor ID code set. To enable this function, a second set of tire pressure warning system sensor ID codes must be registered by a Toyota dealer. For information regarding changing the registered ID code set, contact your Toyota dealer.

\*: The country of production is written on the Certification Regulation label. (→P.665)

- “Scheduled Maintenance” (→P.565)

Select to reset the scheduled maintenance information (message indicating maintenance is required and distance until the next maintenance) after all maintenance is performed.

### ■ Settings

- “Language”

Select to change the language on the multi-information display.

- “Units”



Select to change the units of measure displayed.

- “Meter Type” (7-inch display)

Select to change the speedometer display.

-  (Eco Driving Indicator Light) (→P.92)

Select to activate/deactivate the Eco Driving Indicator Light.

-  (Driving information display settings)

Select to change the display on Fuel Economy (→P.91).

-  (Audio settings) (if equipped)

Select to enable/disable  screen.

-  (Vehicle information display settings)

- “Display Contents”

Select to enable/disable the AWD system display (→P.94). (AWD models)

- “Drive Info Type”

Select to change the drive information type display between trip and total. (→P.93).

- “Drive Info Items”

Select to set the items on the upper and lower side of the drive information screen. from three items, average speed, distance and total time.

- “Pop-Up Display”

Select to enable/disable the following pop-up displays, which may appear in some situations.

- Intersection guidance display of the navigation system-linked system (if equipped)
  - Incoming call display of the hands-free phone system (if equipped)
  - Audio operation (if equipped)
  - Volume operation (if equipped)
  - Voice control (if equipped)
  - Stop & Start system duration (if equipped)
  - Stop & Start system status (if equipped)
  - “MID OFF”
- A blank screen is displayed
- “Default Settings”
- Select to reset the meter display settings.

#### ■ Suspension of the settings display

- In the following situations, operation of the settings display will be temporarily suspended.
  - When a warning message appears on the multi-information display
  - When the vehicle begins to move
- Settings for functions not equipped to the vehicle are not displayed.
- When a function is turned off, the related settings for that function are not selectable.

**⚠ WARNING****■ Cautions during setting up the display**

As the engine needs to be running during setting up the display, ensure that the vehicle is parked in a place with adequate ventilation. In a closed area such as a garage, exhaust gases including harmful carbon monoxide (CO) may collect and enter the vehicle. This may lead to death or a serious health hazard.

**⚠ NOTICE****■ During setting up the display**

To prevent battery discharge, ensure that the engine is running while setting up the display features.

**Warning message display**

Select to display warning messages and measures to be taken if a malfunction is detected. (→P.639)

**Suggestion function**

Displays suggestions to the driver in the following situations. To select a response to a displayed suggestion, use the meter control switches.

**■ Suggestion to turn on the headlights**

If the headlight switch is in other than  or AUTO, and the vehicle speed is 3 mph (5 km/h) or higher for a certain amount of time when the surroundings are

dark, a suggestion message will be displayed.

**■ Suggestion to turn off the headlights**

If the headlights are left on for a certain amount of time after the engine switch has been turned off, a suggestion message will be displayed.

When the headlight switch is in the AUTO position: The message asking if you wish to turn the headlights off is displayed. To turn the headlights off, select "Yes".

If the driver's door is opened after the engine switch is turned off, this suggestion message will not be displayed.

**■ Customization**

The suggestion function can be turned on/off. (Customizable features: →P.689)

**Fuel consumption information**

**The fuel consumption information can be displayed on the audio system screen.**

**System components**

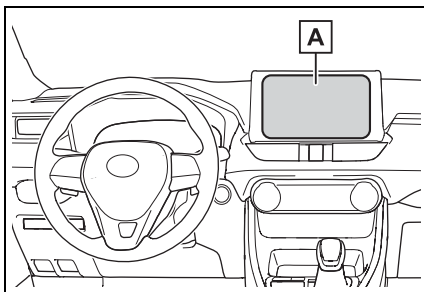

**A** Audio system screen

**Consumption**

■ **Trip information**

► Audio or Audio Plus (vehicles without Data Communication Module)

- 1 Press the "MENU" button.
- 2 Select "Info" on the "Menu" screen.

If the "History" screen is displayed, select "Trip information".

► Audio or Audio Plus (vehicles with Data Communication Module)/Premium Audio

- 1 Press the "MENU" button.
- 2 Select "Info" on the "Menu" screen.

- 3 Select "ECO" on the "Information" screen.

If the "History" screen is displayed, select "Trip information".

The image is an example only, and may vary slightly from actual conditions.

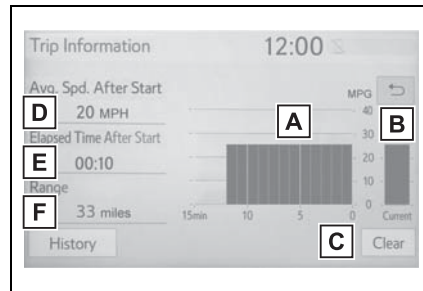

- A** Fuel consumption in the past 15 minutes
- B** Current fuel consumption
- C** Resetting the consumption data
- D** Average vehicle speed since the engine was started
- E** Elapsed time since the engine was started
- F** Cruising range (→P.100)

Average fuel consumption for the past 15 minutes is divided by color into past averages and averages attained since the engine switch was last turned to ON. Use the displayed average fuel consumption as a reference.

2

Vehicle status information and indicators

■ **History**

▶ Audio or Audio Plus (vehicles without Data Communication Module)

- 1 Press the “MENU” button.
- 2 Select “Info” on the “Menu” screen.

If the “Trip Information” screen is displayed, select “History”.

▶ Audio or Audio Plus (vehicles with Data Communication Module)/Premium Audio

- 1 Press the “MENU” button.
- 2 Select “Info” on the “Menu” screen.
- 3 Select “ECO” on the “Information” screen.

If the “Trip Information” screen is displayed, select “History”.

The image is an example only, and may vary slightly from actual conditions.

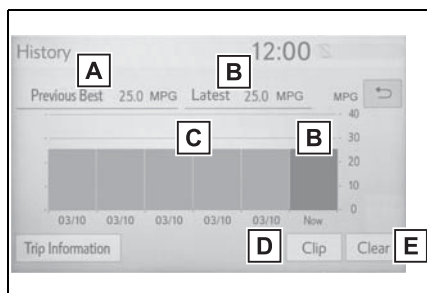

**A** Best recorded fuel consumption

**B** Latest fuel consumption

**C** Previous fuel consumption record

• Audio and Audio Plus:

Displays the daily average fuel consumption.

(Instead of the date, “Trip 1” through “Trip 5” will be displayed.)

• Premium Audio:

Displays the daily average fuel consumption.

**D** Updating the latest fuel consumption data

**E** Resetting the history data

The average fuel consumption history is divided by color into past averages and the average fuel consumption since the last time updated. Use the displayed average fuel consumption as a reference.

■ **Updating the history data**

Update the average fuel consumption by selecting “Clip” to measure the current fuel consumption again.

■ **Resetting the data**

The fuel consumption data can be deleted by selecting “Clear”.

■ **Cruising range**

Displays the estimated maximum distance that can be driven with the quantity of fuel remaining.

This distance is computed based on your average fuel consumption. As a result, the actual distance that can be driven may differ from that displayed.

**Before driving****3****3-1. Key information**

Keys ..... 102

**3-2. Opening, closing and locking the doors**

Side doors ..... 108

Back door ..... 114

Smart key system ..... 128

**3-3. Adjusting the seats**

Front seats ..... 134

Rear seats ..... 135

Driving position memory  
..... 137

Head restraints ..... 140

**3-4. Adjusting the steering wheel and mirrors**

Steering wheel ..... 142

Inside rear view mirror 143

Digital Rear-view Mirror 145

Outside rear view mirrors  
..... 154**3-5. Opening, closing the windows and moon roof**

Power windows ..... 156

Moon roof ..... 159

Panoramic moon roof.. 162

**Keys**

**Key types**

The following keys are provided with the vehicle.

- ▶ Vehicles without smart key system

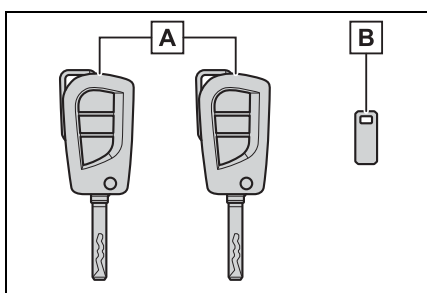

**A Master keys**

Operating the wireless remote control function (→P.104)

**B Key number plate**

- ▶ Vehicles with smart key system

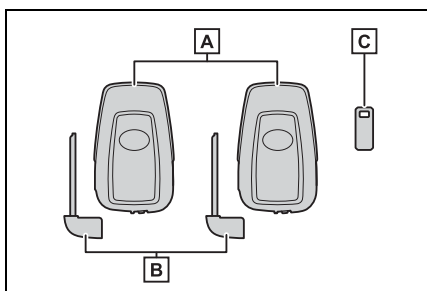

**A Electronic keys**

- Operating the smart key system (→P.128)
- Operating the wireless remote control function (→P.104)

**B Mechanical keys**

**C Key number plate**

**■ When riding in an aircraft**

When bringing a key with wireless remote control function onto an aircraft, make sure you do not press any buttons on the key while inside the aircraft cabin. If you are carrying the key in your bag etc., ensure that the buttons are not likely to be pressed accidentally. Pressing a button may cause the key to emit radio waves that could interfere with the operation of the aircraft.

**■ Key battery depletion**

- ▶ Vehicles without smart key system

- The standard battery life is 1 to 2 years.
- The battery will become depleted even if the wireless key is not used. The following symptoms indicate that the wireless key battery may be depleted. Replace the battery when necessary. (→P.604)
  - The wireless remote control does not operate.
  - The detection area becomes smaller.

- ▶ Vehicles with smart key system

- The standard battery life is 1 to 2 years.
- If the battery becomes low, an alarm will sound in the cabin and a message will be displayed on the multi-information display when the engine stops.
- To reduce key battery depletion when the electronic key is to not be used for long periods of time, set the electronic key to the battery-saving mode. (→P.129)
- As the electronic key always receives radio waves, the battery will become depleted even if the electronic key is not used. The following symptoms indicate that the electronic key battery may be depleted. Replace the battery when necessary.

- The smart key system or the wireless remote control does not operate.
- The detection area becomes smaller.
- The LED indicator on the key surface does not turn on.

You can replace the battery by yourself (→P.604). However, as there is a danger that the electronic key may be damaged, it is recommended that replacement is carried out by your Toyota dealer.

- To avoid serious deterioration, do not leave the electronic key within 3 ft. (1 m) of the following electrical appliances that produce a magnetic field:
  - TVs
  - Personal computers
  - Cellular phones, cordless phones and battery chargers
  - Table lamps
  - Induction cookers

■ **If a message regarding the state of the electronic key or engine switch mode, etc. is shown (vehicles with smart key system)**

To prevent trapping the electronic key inside the vehicle, leaving the vehicle carrying the electronic key on your person without turning the engine switch to OFF or other passengers from unintentionally taking the key out of the vehicle, etc., a message that prompts the user to confirm the state of the electronic key or engine switch mode may be shown on the multi-information display. In those cases, follow the instructions on the display immediately.

■ **If “Key Battery Low Replace Key Battery” is displayed on the multi-information display (vehicles with smart key system)**

The electronic key has a low battery. Replace the electronic key battery.

(→P.604)

■ **Replacing the battery**

→P.604

■ **Confirmation of the registered key number**

The number of keys already registered to the vehicle can be confirmed. Ask your Toyota dealer for details.

■ **If “A New Key has been Registered Contact Your Dealer for Details” is displayed on the multi-information display (vehicles with smart key system)**

This message will be displayed each time the driver’s door is opened when the doors are unlocked from the outside for approximately 10 days after a new electronic key has been registered. If this message is displayed but you have not had a new electronic key registered, ask your Toyota dealer to check if an unknown electronic key (other than those in your possession) has been registered.

	NOTICE
<p>■ <b>To prevent key damage</b></p> <ul style="list-style-type: none"> <li>● Do not drop the keys, subject them to strong shocks or bend them.</li> <li>● Do not expose the keys to high temperatures for long periods of time.</li> <li>● Do not get the keys wet or wash them in an ultrasonic washer, etc.</li> <li>● Do not attach metallic or magnetic materials to the keys or place the keys close to such materials.</li> <li>● Do not disassemble the keys.</li> </ul>	

 NOTICE

- Do not attach a sticker or anything else to the surface of the keys.
- Do not place the keys near objects that produce magnetic fields, such as TVs, audio systems and induction cookers.
- Do not place the keys near medical electrical equipment such as low-frequency therapy equipment or microwave therapy equipment, and do not receive medical attention with the keys on your person.

■ **Carrying the electronic key on your person (vehicles with smart key system)**

Carry the electronic key 3.9 in. (10 cm) or more away from electric appliances that are turned on. Radio waves emitted from electric appliances within 3.9 in. (10 cm) of the electronic key may interfere with the key, causing the key to not function properly.

■ **In case of a smart key system malfunction or other key-related problems (vehicles with smart key system)**

→P.653

■ **When an electronic key is lost (vehicles with smart key system)**

→P.653

**Wireless remote control**

The keys are equipped with the following wireless remote control:

▶ Vehicles without smart key system

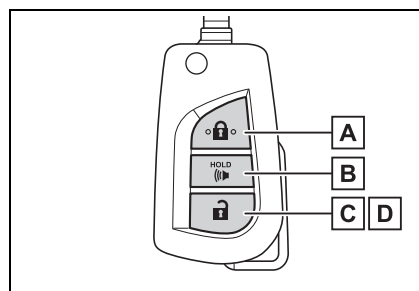

- A** Locks all the doors (→P.108)
- B** Sounds the alarm (→P.105)
- C** Unlocks all the doors (→P.108)
- D** Opens the side windows\* (→P.108)

\*: This setting must be customized at your Toyota dealer.

▶ Vehicles with smart key system

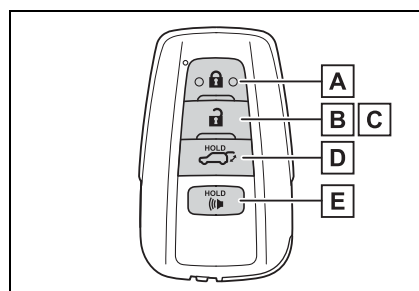

- A** Locks all the doors (→P.108)
- B** Unlocks all the doors (→P.108)
- C** Opens the side windows\*<sup>1</sup> and the moon roof\*<sup>1, 2</sup> or panoramic moon roof\*<sup>1, 2</sup> (→P.108)



**D** Opens and closes the power back door\*<sup>2</sup> (→P.118)

**E** Sounds the alarm (→P.105)

\*<sup>1</sup>: These settings must be customized at your Toyota dealer.

\*<sup>2</sup>: If equipped

**■ Theft deterrent panic mode**

▶ Vehicles without smart key system

When  is pressed for longer than about 1 second, an alarm will sound intermittently and the vehicle lights will flash to deter any person from trying to break into or damage your vehicle.

To stop the alarm, press any button on the key.

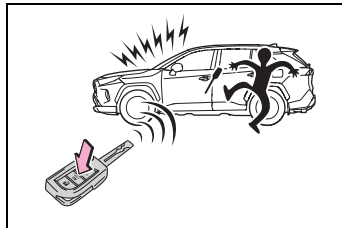

▶ Vehicles with smart key system

When  is pressed for longer than about 1 second, an alarm will sound intermittently and the vehicle lights will flash to deter any person from trying to break into or damage your vehicle.

To stop the alarm, press any button on the electronic key.

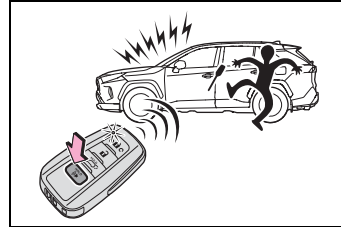

**■ Conditions affecting operation**

▶ Vehicles without smart key system  
The wireless remote control function may not operate normally in the following situations.

- When the wireless key battery is depleted
  - Near a TV tower, electric power plant, gas station, radio station, large display, airport or other facility that generates strong radio waves or electrical noise
  - When carrying a portable radio, cellular phone or other wireless communication device
  - When the wireless key is in contact with, or is covered by a metallic object
  - When other wireless key (that emits radio waves) is being used nearby
  - If window tint with a metallic content or metallic objects are attached to the rear window
- ▶ Vehicles with smart key system  
→P.129

■ Certification for wireless remote control

FCC ID:HYQ23ABE  
FCC ID:HYQ12BFW

NOTE:

This device complies with part 15 of the FCC Rules. Operation is subject to the following two conditions: (1) This device may not cause harmful interference, and (2) this device must accept any interference received, including interference that may cause undesired operation.

FCC WARNING:

Changes or modifications not expressly approved by the party responsible for compliance could void the user's authority to operate the equipment.

<For 12BFW>

The FCC ID is affixed inside the equipment. You can find the ID when replacing the battery.

<RKE Transmitter, TPM/RKE Integrated Receiver>  
TRW Automotive

RKE Transmitter  
Model: 336600  
FCC ID: GQ4-73T  
IC: 1470A-54T

Integrated Receiver  
Model: 337136  
FCC ID: GQ4-50R  
CAN RSS-GEN/CNR-GEN

MADE IN U.S.A.

This device complies with Part 15 of the FCC Rules and with Canada license-exempt RSS standard(s). Operation is subject to the following two conditions:

- (1) This device may not cause harmful interference, and
- (2) This device must accept any interference received, including interference that may cause undesired operation.

Le present appareil est conforme aux CNR d' Industrie Canada applicable aux appareils radio exempts de licence.

L' exploitation est autorisee aux deux conditions suivantes:

- (1) L' appareil ne doit pas produire de brouillage.
- (2) L' utilisateur de l' appareil doit accepter tout brouillage radioelectrique subi, meme si le brouillage est susceptible d' en compromettre le fonctionnement.

WARNING: Changes or modifications not expressly approved by TRW Automotive U.S. LLC could void the user's authority to operate the equipment.  
The term "IC:" before the radio certification

**Using the master key  
(vehicles without smart  
key system)**

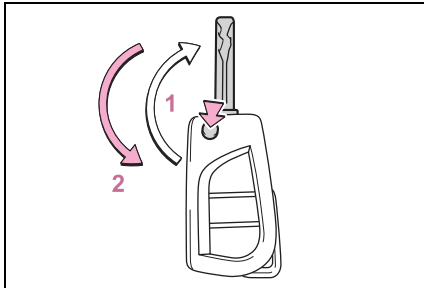

- 1 Releasing**  
To release the key, press the button.
- 2 Folding**  
To stow the key back in its case, push the key back to the stowed position while pressing the button.

**Using the mechanical key  
(vehicles with smart key  
system)**

To take out the mechanical key, slide the release lever **A** and take the key out.

The mechanical key can only be inserted in one direction, as the key only has grooves on one side. If the key cannot be inserted in a lock cylinder, turn it over and re-attempt to insert it.

After using the mechanical key, store it in the electronic key. Carry the mechanical key together with the electronic key. If the electronic key battery is depleted or the entry function does not operate properly, you will need the mechanical key.

(→P.653)

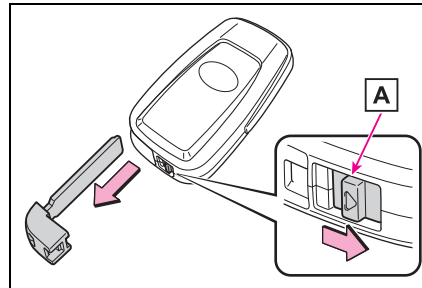

- **If you lose your keys**  
→P.653
- **If a wrong key is used**  
The key cylinder rotates freely to isolate inside mechanism.

**3**  
Before driving

Side doors

The vehicle can be locked and unlocked using the entry function, wireless remote control, key or door lock switch.

Unlocking and locking the doors from the outside

■ Using the entry function (vehicles with smart key system)

Carry the electronic key to enable this function.

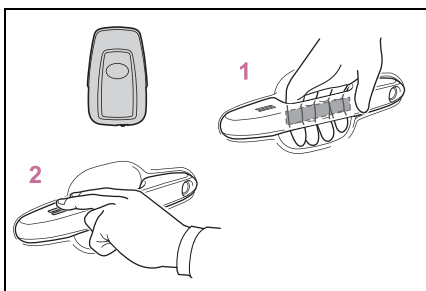

- 1 Grip the driver's door handle to unlock the door. Holding the driver's door handle for approximately 2 seconds unlocks all the doors. Grip the front passenger's door handle or rear door handle (some models) to unlock all the doors\*.

Make sure to touch the sensor on the back of the handle. The doors cannot be unlocked for 3 seconds after the doors are locked.

\*: The door unlock settings can be

changed. (→P.109)

- 2 Touch the lock sensor (the indentation on the upper part of the door handle) to lock the doors.

Check that the door is securely locked.

■ Using the wireless remote control

- ▶ Vehicles without smart key system

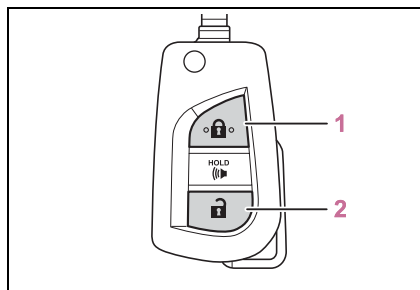

- 1 Locks all the doors

Check that the door is securely locked.

- 2 Unlocks all the doors

Pressing the button unlocks the driver's door. Pressing the button again within 5 seconds unlocks the other doors.

Press and hold to open the side windows.\*

\*: This setting must be customized at your Toyota dealer.

▶ Vehicles with smart key system

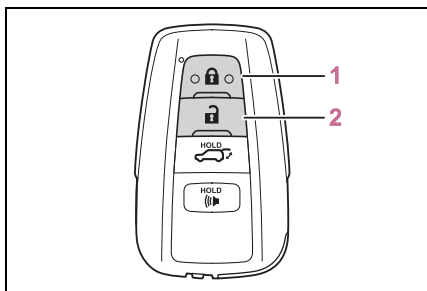

- 1 Locks all the doors  
Check that the door is securely locked.
- 2 Unlocks all the doors  
Pressing the button unlocks the driver's door. Pressing the button again within 5 seconds unlocks the other doors.  
Press and hold to open the side windows and moon roof (if equipped) or panoramic moon roof (if equipped).\*

\*: This setting must be customized at your Toyota dealer.

■ Using the key

▶ Vehicles without smart key system

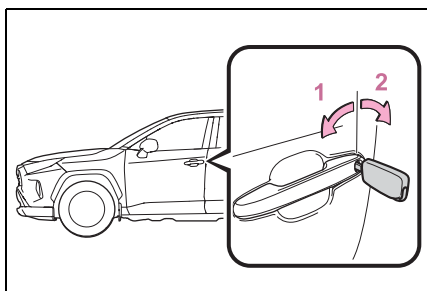

- 1 Locks all the doors  
Turn and hold to close the side windows.\*

- 2 Unlocks all the doors  
Turning the key unlocks the driver's door. Turning the key again within 5 seconds unlocks the other doors.  
Turn and hold to open the side windows.\*





\*: These settings must be customized at your Toyota dealer.

▶ Vehicles with smart key system



The doors can also be locked and unlocked with the mechanical key. (→P.653)

■ Switching the door unlock function (vehicles with smart key system)

It is possible to set which doors the entry function unlocks using the wireless remote control.

- 1 Turn the engine switch to OFF.
- 2 When the indicator light on the key surface is not on, press and hold  ,  or  for approximately 5 seconds while pressing and holding  .

The setting changes each time an operation is performed, as shown below. (When changing the setting continuously, release the buttons, wait for at least 5 seconds, and repeat step 2.)

Multi-information display/Beep	Unlocking function
 <p>Exterior: Beeps 3 times Interior: Pings once</p>	<p>Holding the driver's door handle unlocks only the driver's door.</p> <hr/> <p>Holding the passenger's door handle or pressing the back door opener switch unlocks all the doors.</p>
 <p>Exterior: Beeps twice Interior: Pings once</p>	<p>Holding a door handle or pressing the back door opener switch unlocks all the doors.</p>

Vehicles with alarm: To prevent unintended triggering of the alarm, unlock the doors using the wireless remote control and open and close a door once after the settings have been changed. (If a door is not opened within 60 seconds after

 is pressed, the doors will be locked again and the alarm will automatically be set.) In a case that the alarm is triggered, immediately stop the alarm. (→P.73)

■ **Operation signals**

Doors: A buzzer sounds and the emergency flashers flash to indicate that the doors have been locked/unlocked using the entry function or wireless remote control. (Locked: Once; Unlocked: Twice)

Side windows and moon roof (if equipped) or panoramic moon roof (if equipped): A buzzer sounds to indicate that the side windows and moon roof or panoramic moon roof

are operating using the wireless remote control.

■ **Security feature**

▶ Vehicles without smart key system

If a door is not opened within approximately 60 seconds after the vehicle is unlocked using the wireless remote control, the security feature automatically locks the vehicle again.

▶ Vehicles with smart key system

If a door is not opened within approximately 60 seconds after the vehicle is unlocked using the entry function or wireless remote control, the security feature automatically locks the vehicle again. (However, depending on the location of the electronic key, the key may be detected as being in the vehicle. In this case, vehicle may be unlocked.)

■ **When the door cannot be locked by the lock sensor on the upper part of the door handle (vehicles with smart key system)**

If the door will not lock even when the topside sensor area is touched, try touching both the topside and underside sensor areas at the same time.

When gloves are being worn, remove the gloves.

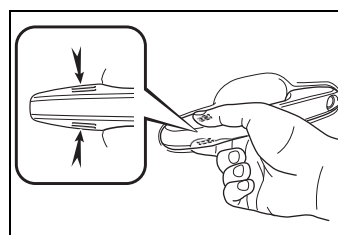

■ **Door lock buzzer (vehicles with smart key system)**

If an attempt to lock the doors using the entry function or wireless remote control is made when a door is not fully closed, a buzzer sounds continuously for 5 seconds. Fully close the door to stop the buzzer, and lock the

vehicle once more.

■ **Setting the alarm (if equipped)**

Locking the doors will set the alarm system. (→P.73)

■ **Conditions affecting the operation of the smart key system or wireless remote control**

▶ Vehicles without smart key system  
→P.105

▶ Vehicles with smart key system  
→P.129

■ **If the smart key system (if equipped) or the wireless remote control does not operate properly**

- Vehicles with smart key system: Use the mechanical key to lock and unlock the doors. (→P.653)
- Replace the key battery with a new one if it is depleted. (→P.604)

■ **If the battery is discharged**

The doors cannot be locked and unlocked using the smart key system (if equipped) or wireless remote control. Lock or unlock the doors using the key (vehicles without smart key system) or mechanical key (vehicles with smart key system). (→P.109, 653)

■ **Customization**

Settings (e.g. unlocking function using a key) can be changed. (Customizable features: →P.690)



**WARNING**

■ **To prevent an accident**

Observe the following precautions while driving the vehicle. Failure to do so may result in a door opening and an occupant could be thrown out of the vehicle, resulting in death or serious injury.

- Ensure that all doors are properly closed and locked.

● Do not pull the inside handle of the doors while driving. Be especially careful for the front doors, as the doors may be opened even if the inside lock buttons are in locked position.

● Set the rear door child-protector locks when children are seated in the rear seats.

■ **When opening or closing a door**

Check the surroundings of the vehicle such as whether the vehicle is on an incline, whether there is enough space for a door to open and whether a strong wind is blowing. When opening or closing the door, hold the door handle tightly to prepare for any unpredictable movement.

■ **When using the wireless remote control, key or mechanical key and operating the power windows, moon roof (if equipped) or panoramic moon roof (if equipped)**

Operate the power window, moon roof or panoramic moon roof after checking to make sure that there is no possibility of any passenger having any of their body parts caught in the side window, moon roof or panoramic moon roof. Also, do not allow children to operate the wireless remote control, key or mechanical key. It is possible for children and other passengers to get caught in the side window, moon roof or panoramic moon roof.

### Unlocking and locking the doors from the inside

#### ■ Using the door lock switch

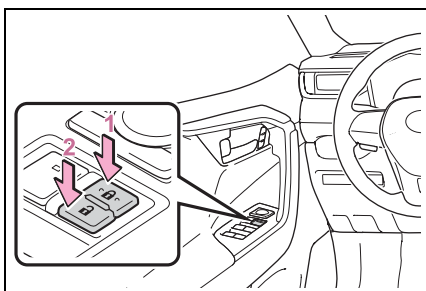

- 1 Locks all the doors
- 2 Unlocks all the doors

#### ■ Using the inside lock buttons

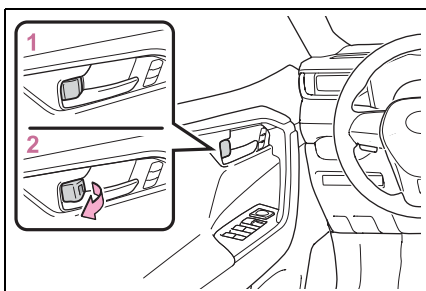

- 1 Locks the door
- 2 Unlocks the door

The front doors can be opened by pulling the inside handle even if the lock buttons are in the lock position.

#### ■ Locking the front doors from the outside without a key

- 1 Move the inside lock button to the lock position.
- 2 Close the door.

#### ▶ Vehicles without smart key system

The door cannot be locked if the key is in the engine switch.

#### ▶ Vehicles with smart key system

The door cannot be locked if the engine switch is in ACC or ON, or the electronic key is left inside the vehicle.

Depending on the position of the electronic key, the key may not be detected correctly and the door may be locked.

#### ■ Open door warning buzzer

If the vehicle speed reaches 3 mph (5 km/h), a buzzer sounds to indicate that the door(s) or the hood is not fully closed.

The open door(s) or hood is displayed on the multi-information display.

#### ■ When all the doors are locked with the entry function (vehicles with smart key system), wireless remote control or key

- The doors cannot be unlocked with the door lock switch.
- The door lock switch can be reset by unlocking all the doors with the entry function (vehicles with smart key system), wireless remote control or key.

### Rear door child-protector lock

The door cannot be opened from inside the vehicle when the lock is set.





- 1 Unlock
- 2 Lock

These locks can be set to prevent children from opening the rear doors. Push down on each rear door switch to lock both rear doors.

### Automatic door locking and unlocking systems

The following functions can be set or canceled:

For instructions on customizing, refer to P.688.

Function	Operation
Speed linked door locking function	All doors are automatically locked when vehicle speed is approximately 12mph (20 km/h) or higher.
Shift position linked door locking function	All doors are automatically locked when shifting the shift lever to position other than P.
Shift position linked door unlocking function	All doors are automatically unlocked when shifting the shift lever to P.
Driver's door linked door unlocking function	All doors are automatically unlocked when driver's door is opened within approximately 45 seconds after turning the engine switch off.

3

Before driving

## Back door

**The back door can be locked/unlocked and opened/closed by the following procedures.**

### WARNING

Observe the following precautions. Failure to do so may result in death or serious injury.

#### ■ Before driving

- Make sure that the back door is fully closed. If the back door is not fully closed, it may open unexpectedly while driving and hit nearby objects or luggage in the luggage compartment may be thrown out, causing an accident.
- Do not allow children to play in the luggage compartment. If a child is accidentally locked in the luggage compartment, they could get heat exhaustion or other injuries.
- Do not allow a child to open or close the back door. Doing so may cause the back door to operate unexpectedly, or cause the child's hands, head, or neck to be caught by the closing back door.

#### ■ Important points while driving

- Keep the back door closed while driving. If the back door is left open, it may hit near-by objects or luggage in the luggage compartment may be thrown out, causing an accident.

- Never let anyone sit in the luggage compartment. In the event of sudden braking, sudden swerving or a collision, they are susceptible to death or serious injury.

#### ■ Back door handles

Do not hang any object to the back door handles. If any object is hung, the back door may suddenly shut, causing parts of the body to be caught, resulting in death or serious injury.

#### ■ Operating the back door

- Observe the following precautions. Failure to do so may cause parts of the body to be caught, resulting in death or serious injury.
- Remove any heavy loads, such as snow and ice, from the back door before opening it. Failure to do so may cause the back door to suddenly shut again after it is opened.
  - When opening or closing the back door, thoroughly check to make sure the surrounding area is safe.
  - If anyone is in the vicinity, make sure they are safe and let them know that the back door is about to open or close.
  - Use caution when opening or closing the back door in windy weather as it may move abruptly in strong wind.

**⚠ WARNING**

- Vehicles without power back door: The back door may suddenly shut if it is not opened fully. It is more difficult to open or close the back door on an incline than on a level surface, so beware of the back door unexpectedly opening or closing by itself. Make sure that the back door is fully open and secure before using the luggage compartment.

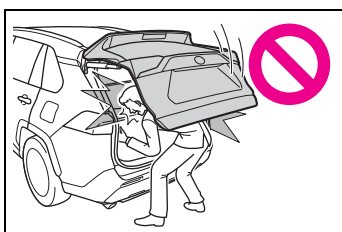

- Vehicles with power back door: The back door may suddenly shut if it is not opened fully, while on a steep incline. Make sure that the back door is secured before using the luggage compartment.
- When closing the back door, take extra care to prevent your fingers, etc. from being caught.

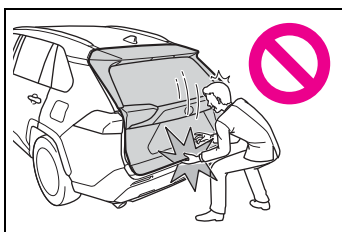

- Vehicles without power back door: When closing the back door, make sure to press it lightly on its outer surface. If the back door handle is used to fully close the back door, it may result in hands or arms being caught.

- Do not pull on the back door damper stay (vehicles without power back door) (→P.118) or back door spindle (vehicles with power back door) (→P.125) to close the back door, and do not hang on the back door damper stay (vehicles without power back door) or back door spindle (vehicles with power back door). Doing so may cause hands to be caught or the back door damper stay (vehicles without power back door) or back door spindle (vehicles with power back door) to break, causing an accident.
- Vehicles without power back door: If a bicycle carrier or similar heavy object is attached to the back door, it may suddenly shut again after being opened, causing someone's hands, head or neck to be caught and injured. When installing an accessory part to the back door, using a genuine Toyota part is recommended.

**Unlocking and locking the back door from the outside**

- **Using the entry function (vehicles with smart key system)**

Carry the electronic key to enable this function.

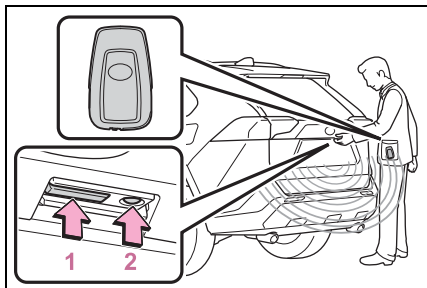

**1** Unlocks all the doors

The doors cannot be unlocked for 3 seconds after the doors are locked.

**2** Locks all the doors

Check that the door is securely locked.

■ **Using the wireless remote control**

→P.108

■ **Operation signals**

A buzzer sounds and the emergency flashers flash to indicate that the doors have been locked/unlocked using the entry function (if equipped) or wireless remote control. (Locked: once; Unlocked: twice)

■ **Security feature**

▶ **Vehicles without smart key system**

If a door is not opened within approximately 60 seconds after the vehicle is unlocked using the wireless remote control, the security feature automatically locks the vehicle again.

▶ **Vehicles with smart key system**

If a door is not opened within approximately 60 seconds after the vehicle is unlocked using the entry function or wireless remote control, the security feature automatically locks the vehicle again. (However, depending on the location of the

electronic key, the key may be detected as being in the vehicle. In this case, vehicle may be unlocked.)

**Unlocking and locking the back door from the inside**

■ **Using the door lock switch**

→P.112

**Opening/closing the back door (vehicles without power back door)**

■ **Open**

Raise the back door while pressing up the back door opener switch.

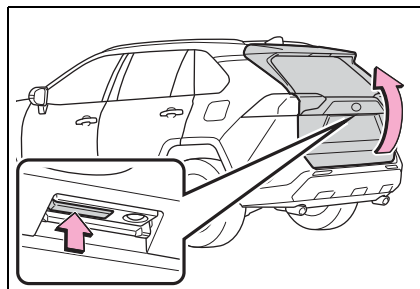

■ **Close**

Lower the back door using the back door handle **A**, and make sure to push the back door down from the outside to close it.

Be careful not to pull the back door sideways when closing the back door with the handle.

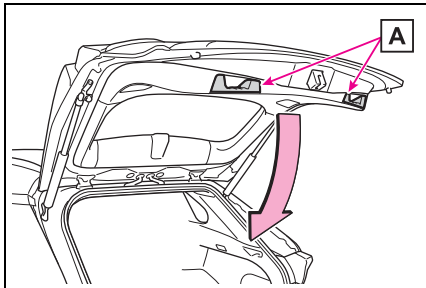

■ **Luggage compartment light**

The luggage compartment light turns on when the back door is opened with the luggage compartment light switch on.

When the engine switch is turned to OFF, the light will go off automatically after 20 minutes.

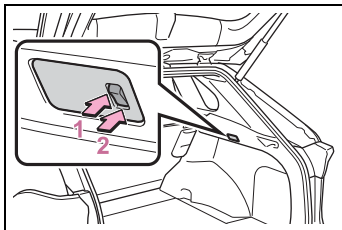

- 1 On
- 2 Off

■ **If the back door opener is inoperative**

The back door can be unlocked from the inside.

- 1 Remove the cover.

To prevent damage, cover the tip of the screwdriver with a rag.

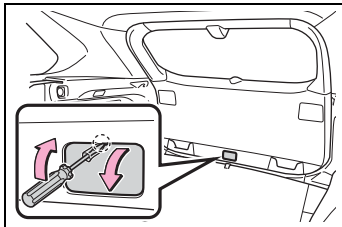

- 2 Loosen the screw.

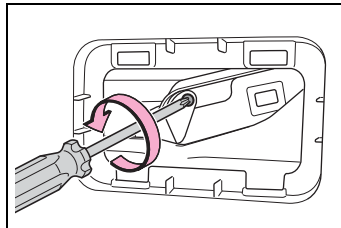

- 3 Turn the cover.

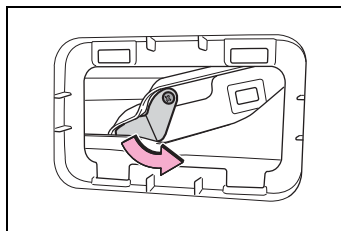

- 4 Move the lever.

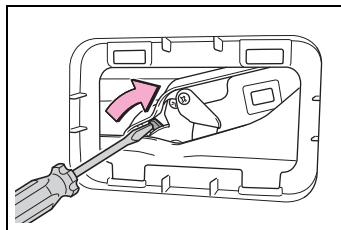

- 5 When installing, reverse the steps listed.

■ **Open door warning buzzer**

→P.112

3  
Before driving

 NOTICE

■ **Back door damper stays**

The back door is equipped with damper stays that hold the back door in place. Observe the following precautions. Failure to do so may cause damage to the back door damper stay, resulting in malfunction.

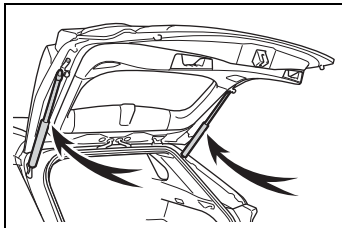

- Do not attach any foreign objects, such as stickers, plastic sheets, or adhesives to the damper stay rod.
- Do not touch the damper stay rod with gloves or other fabric items.
- Do not attach any accessories other than genuine Toyota parts to the back door.
- Do not place your hand on the damper stay or apply lateral forces to it.

**Opening/closing the back door (vehicles with power back door)**

■ **Using the wireless remote control**

Press and hold the switch.

The power back door automatically opens/closes.

Pressing the switch while the power back door is opening/closing stops

the operation. When the switch is pressed again during the halted operation, the back door will perform the reverse operation.

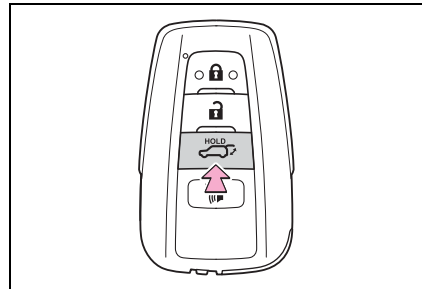

■ **Using the power back door switch on the instrument panel**

Press and hold the switch.

The power back door automatically opens/closes.

Unlock the back door before operating.

Pressing the switch while the power back door is opening/closing stops the operation. When the switch is pressed again during the halted operation, the back door will perform the reverse operation.

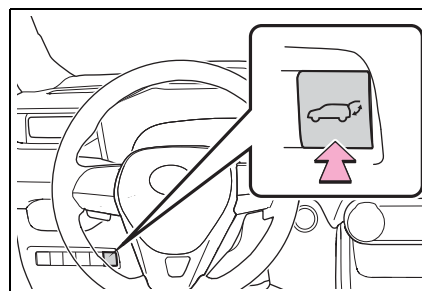

■ **Using the back door opener switch**

When the back door is unlocked: Press the back door

opener switch.

When the back door is locked:  
While carrying the electronic key on your person, press and hold the back door opener switch.

The power back door automatically opens.

Pressing the switch while the power back door is opening/closing stops the operation.

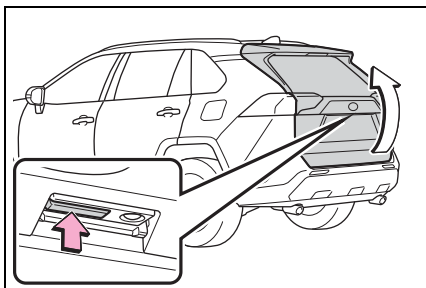

■ **Using the power back door switch on the back door**

Press the switch.

The power back door automatically closes.

Pressing the switch while the power back door is operating will stop the operation.

When the switch is pressed again during the halted operation, the back door will perform the reverse operation.

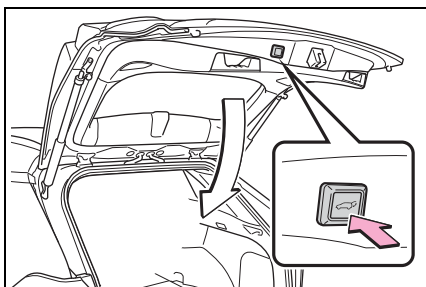

■ **Using the back door handles**

Lower the back door using the back door handle **A**.

The back door closing assist (→P.121) will be activated, and the power back door will fully close automatically.

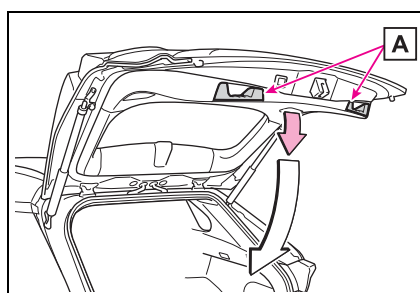

■ **Using the kick sensor (vehicles with Hands Free Power Back Door)**

The Hands Free Power Back Door enables automatic opening and closing of the power back door by putting your foot near the lower center part of the rear bumper and moving it away from the rear bumper. When operating the Hands Free Power Back Door, make sure that the engine switch is in OFF, the kick sensor operation is enabled (→P.94) and you are carrying an electronic key.

- 1 While carrying an electronic key, stand within the smart key system operation range, approximately 11.8 to 19.7 in.

(30 to 50 cm) from the rear bumper.

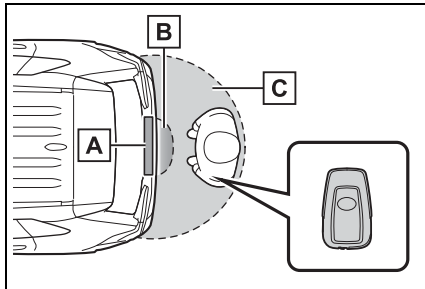

- A** Kick sensor
- B** Hands Free Power Back Door operation detection area
- C** Smart key system operation detection area (→P.128)

2 Perform a kick operation by moving your foot to within approximately 3.9 in. (10 cm) of the rear bumper and then pulling it back.

Perform the entire kick operation within 1 second.

The back door will not start operating while a foot is detected under the rear bumper.

Operate the Hands Free Power Back Door without contacting the rear bumper with your foot.

If another electronic key is in the cabin or luggage compartment, it may take slightly longer than nor-

mal for the operation to occur.

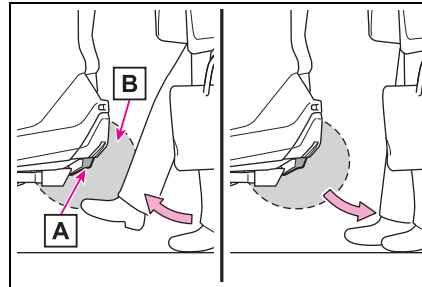

- A** Kick sensor
- B** Hands Free Power Back Door operation detection area

3 When the kick sensor detects that your foot is pulled back, a buzzer will sound and the back door will automatically fully open/close.

If a foot is moved under the rear bumper while the back door is opening/closing, the back door will stop moving.

If a foot is moved under the rear bumper again during the halted operation, the back door will perform the reverse operation.

#### ■ Luggage compartment light

The luggage compartment light turns on when the back door is opened with the luggage compartment light switch on.

When the engine switch is turned to OFF, the light will go off automatically after 20 minutes.

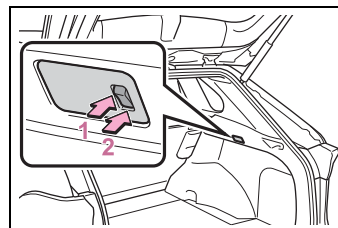



1 On

2 Off

#### ■ Back door closer

In the event that the back door is left slightly open, the back door closer will automatically close it to the fully closed position.

Whatever the state of the engine switch, the back door closer operates.

#### ■ Power back door operating conditions

The power back door can automatically open and close under the following conditions:

- When the power back door system is enabled. (→P.94)
- When the engine switch is in ON, in addition to the above for the opening operations, the back door operates for any of the following conditions:
  - Parking brake is engaged
  - The brake pedal is depressed
  - The shift lever is in P.

#### ■ Operation of the power back door

- A buzzer sounds and the emergency flashers flash twice to indicate that the back door is opening/closing.
- When the power back door system is disabled, the power back door does not operate but it can be opened and closed by hand.
- When the power back door automatically opens, if an abnormality due to people or objects is detected, operation will stop.

#### ■ Jam protection function

Sensors are equipped on both sides of the power back door. If anything obstructs the power back door while it is closing, the back door will automatically operate in the opposite direction or stop.

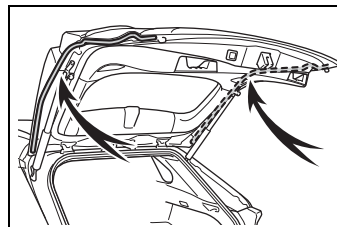

#### ■ Fall-down protection function

While the power back door is opening automatically, applying excessive force to it will stop the opening operation to prevent the power back door from suddenly shutting.

#### ■ Back door closing assist

If the back door is lowered manually when the back door is stopped at an open position, the back door will fully close automatically.

#### ■ Back door reserve lock function

This function is a function which reserves locking of all doors, beforehand, when the power back door is open.

When the following procedure is performed, all the doors except the power back door are locked and then power back door will also be locked at the same time it is closed.

- 1 Close all doors, except the back door.
- 2 During the power back door closing operation, lock the doors using the smart key system from the side doors (→P.108) or the wireless remote control. (→P.108)

A buzzer sounds and the emergency flashers flash to indicate that all the doors have been closed and locked.

- If the electronic key is placed inside the vehicle after starting a close operation via the door reserve lock function, the electronic key may become locked inside the vehicle.
- If the power back door does not fully close due to the operation of

3

Before driving

the jam protection function, etc., while the back door is automatically closing after a door reserve lock operation is performed, the door reserve lock function is canceled and all the doors will unlock.

- Before leaving the vehicle, make sure that all the doors are closed and locked.
- **Kick sensor operating conditions (vehicles with Hands Free Power Back Door)**

The Hands Free Power Back Door will open/close automatically when the following conditions are met:

- The kick sensor operation is enabled (→P.94)
- The engine switch is in OFF.
- The electronic key is within the operational range. (→P.128)
- A foot is put near the lower center part of the rear bumper and moved away from the rear bumper.

The power back door may also be operated by putting a hand, an elbow, a knee, etc. near the lower center part of the rear bumper and moving it away from the rear bumper. Make sure to put it close enough to the center part of the rear bumper.

- **Situations in which the Hands Free Power Back Door may not operate properly (vehicles with Hands Free Power Back Door)**

In the following situations, the Hands Free Power Back Door may not operate properly:

- When a foot remains under the rear bumper
- If the rear bumper is strongly hit with a foot or is touched for a while

If the rear bumper has been touched for a while, wait for a short time before attempting to operate the Hands Free Power Back Door again.

- When operated while a person is too close to the rear bumper
- When an external radio wave source interferes with the communication between the electronic key and the vehicle (→P.129)
- When the vehicle is parked near an electrical noise source which affects the sensitivity of the Hands Free Power Back Door, such as a pay parking spot, gas station, electrically heated road, or fluorescent light
- When the vehicle is near a TV tower, electric power plant, radio station, large display, airport or other facility that generates strong radio waves or electrical noise
- When a large amount of water is applied to the rear bumper, such as when the vehicle is being washed or in heavy rain
- When mud, snow, ice, etc. is attached to the rear bumper
- When the vehicle has been parked for a while near objects that may move and contact the rear bumper, such as plants
- When an accessory is installed to the rear bumper

If an accessory has been installed, turn the Hands Free Power Back Door (kick sensor) operation setting off.

- **Preventing unintentional operation of the Hands Free Power Back Door (vehicles with Hands Free Power Back Door)**

When an electronic key is in the operation range, the Hands Free Power Back Door may operate unintentionally, so be careful in the following situations.

- When a large amount of water is applied to the rear bumper, such as when the vehicle is being washed or in heavy rain
- When dirt is wiped off the rear

bumper

- When a small animal or small object, such as a ball, moves under the rear bumper
  - When an object is moved from under the rear bumper
  - If someone is swinging their legs while sitting on the rear bumper
  - If the legs or another part of someone's body contacts the rear bumper while passing by the vehicle
  - When the vehicle is parked near an electrical noise source which affects the sensitivity of the Hands Free Power Back Door, such as a pay parking spot, gas station, electrically heated road, or fluorescent light
  - When the vehicle is near a TV tower, electric power plant, radio station, large display, airport or other facility that generates strong radio waves or electrical noise
  - When the vehicle is parked in a place where objects such as plants are near the rear bumper
  - If luggage, etc. is set near the rear bumper
  - If accessories or a vehicle cover is installed/removed near the rear bumper
  - When the vehicle is being towed
- To prevent unintentional operation, turn the Hands Free Power Back Door (kick sensor) operation setting off. (→P.94)

■ **When reconnecting the battery**

To enable the power back door to operate properly, close the back door manually.

■ **If the back door opener is inoperative**

The back door can be unlocked from the inside.

- 1 Remove the cover.

To prevent damage, cover the tip of the screwdriver with a rag.

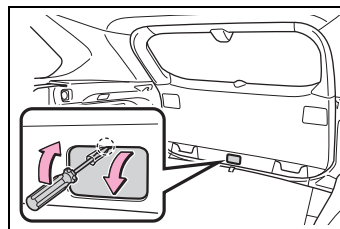

- 2 Loosen the screw.

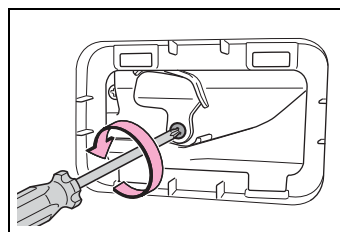

- 3 Turn the cover.

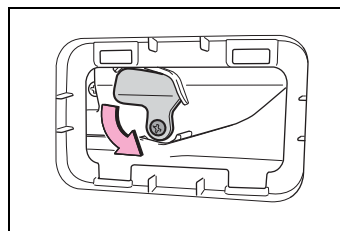

- 4 Move the lever.

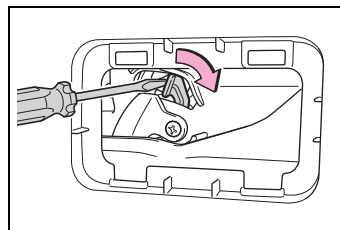

- 5 When installing, reverse the steps listed.

■ **Customization**

Settings (e.g. power back door opening angle) can be changed. (Customizable features: →P.692)

3 Before driving

**⚠ WARNING**

■ **Back door closer**

- In the event that the back door is left slightly open, the back door closer will automatically close it to the fully closed position. It takes several seconds before the back door closer begins to operate. Be careful not to catch fingers or anything else in the back door, as this may cause bone fractures or other serious injuries.

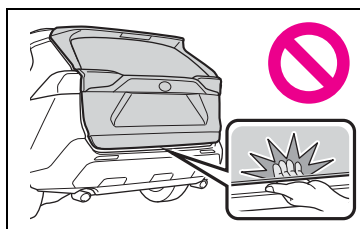

- Use caution when using the back door closer as it still operates when the power back door system is canceled.

■ **Power back door**

Observe the following precautions when operating the power back door.

Failure to do so may cause death or serious injury.

- Check the safety of the surrounding area to make sure there are no obstacles or anything that could cause any of your belongings to get caught.
- If anyone is in the vicinity, make sure they are safe and let them know that the back door is about to open or close.

- If the power back door system is turned off while the back door is operating automatically, the automatic operation is stopped. The back door then has to be operated manually. Take extra care when on an incline, as the back door may open or close unexpectedly.

- If the operating conditions of the power back door are no longer met, a buzzer may sound and the back door may stop opening or closing. The back door then has to be operated manually. Take extra care when on an incline, as the back door may open or close abruptly.

- On an incline, the back door may suddenly shut after it opens. Make sure the back door is fully open and secure.

- In the following situations, the power back door may detect an abnormality and automatic operation may be stopped. In this case, the back door has to be operated manually. Take extra care when on an incline, as the back door may open or close abruptly.

- When the back door contacts an obstacle
- When the battery voltage suddenly drops, such as when the engine switch is turned to ON or the engine is started during automatic operation

- If a bicycle carrier or similar heavy object is attached to the back door, it may suddenly shut again after being opened, causing someone's hands, head or neck to be caught and injured. When installing an accessory part to the back door, using a genuine Toyota part is recommended.

**⚠ WARNING****■ Jam protection function**

Observe the following precautions.  
Failure to do so may cause death or serious injury.

- Never use any part of your body to intentionally activate the jam protection function.
- The jam protection function may not work if something gets caught just before the back door fully closes. Be careful not to catch fingers or anything else.
- The jam protection function may not work depending on the shape of the object that is caught. Be careful not to catch fingers or anything else.

**■ Hands Free Power Back Door (if equipped)**

Observe the following precautions when operating the Hands Free Power Back Door.  
Failure to do so may cause death or serious injury.

- Check the safety of the surrounding area to make sure there are no obstacles or anything that could cause any of your belongings to get caught.
- When putting your foot near the lower center part of the rear bumper and moving it from the rear bumper, be careful not to touch the exhaust pipes until they have cooled down sufficiently, as touching hot exhaust pipes can cause burns.
- Do not leave the electronic key within the effective range (detection area) of the luggage compartment.

**⚠ NOTICE****■ Back door spindles**

The back door is equipped with spindles that hold the back door in place.

Observe the following precautions.

Failure to do so may cause damage to the back door spindle, resulting in malfunction.

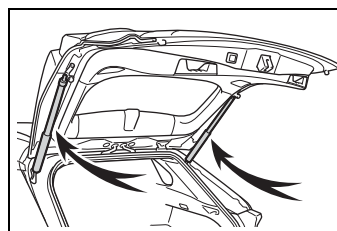

- Do not attach any foreign objects, such as stickers, plastic sheets, or adhesives to the spindle rod.
- Do not touch the spindle rod with gloves or other fabric items.
- Do not attach heavy accessories to the back door. When attaching, ask your Toyota dealer for details.
- Do not place your hand on the spindle or apply lateral forces to it.

**■ To prevent back door closer malfunction**

Do not apply excessive force to the back door while the back door closer is operating. Applying excessive force may cause the back door closer to malfunction.



## NOTICE

■ **To prevent damage to the power back door**

- Make sure that there is no ice between the back door and frame that would prevent movement of the back door. Operating the power back door when excessive load is present on the back door may cause a malfunction.
- Do not apply excessive force to the back door while the power back door is operating.
- Take care not to damage the sensors (installed on the right and left edges of the power back door) with a knife or other sharp object. If the sensor is disconnected, the power back door will not close automatically.

■ **Hands Free Power Back Door precautions (if equipped)**

The kick sensor is located behind lower center part of the rear bumper. Observe the following to ensure that the Hands Free Power Back Door function operates properly:

- Keep the lower center part of the rear bumper clean at all times.  
If the lower center part of the rear bumper is dirty or covered with snow, the kick sensor may not operate. In this situation, clean off the dirt or snow, move the vehicle from the current position and then check if the kick sensor operates.  
If it does not operate, have the vehicle inspected by your Toyota dealer.
- Do not apply coatings that have a rain clearing (hydrophilic) effect, or other coatings, to the lower center part of the rear bumper.

- Do not park the vehicle near objects that may move and contact the lower center part of the rear bumper, such as grass or trees.

If the vehicle has been parked for a while near objects that may move and contact the lower center part of the rear bumper, such as grass or trees, the kick sensor may not operate. In this situation, move the vehicle from the current position and then check if the kick sensor operates. If it does not operate, have the vehicle inspected by your Toyota dealer.

- Do not subject the kick sensor or its surrounding area to a strong impact.  
If the kick sensor or its surrounding area has been subjected to a strong impact, the kick sensor may not operate properly. If the kick sensor does not operate in the following situations, have the vehicle inspected by your Toyota dealer.
  - The kick sensor or its surrounding area has been subjected to a strong impact.
  - The lower center part of the rear bumper is scratched or damaged.
- Do not disassemble the rear bumper.
- Do not attach stickers to the rear bumper.
- Do not paint the rear bumper.
- If a bicycle carrier or similar heavy object is attached to the power back door, disable the kick sensor. (→P.94)

### Changing settings of the power back door system (vehicles with power back door)

The settings of the power back door system can be changed by displaying the "Vehicle Settings" - "PBD" screen from the

⚙️ screen of the multi-information display. (→P.94)

The changed power back door settings are not reset by turning the engine switch to OFF. In order to restore the original settings, they need to be changed back on the

⚙️ screen of the multi-information display.

### Adjusting the open position of the back door (vehicles with power back door)

The open position of the power back door can be adjusted.

- 1 Stop the back door in the desirable position. (→P.118)
- 2 Press and hold the power back door switch on the back door for approximately 2 seconds.

When the settings are completed, the buzzer sounds 4 times.

When opening the back door the next time, the back door will stop at

that position.

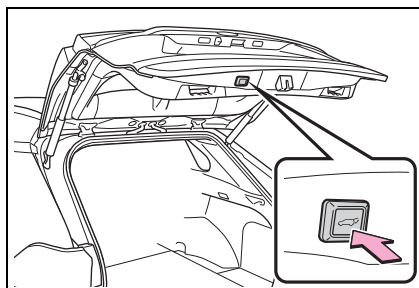

### Canceling the adjusted open position of the back door

Press and hold the power back door switch on the back door for approximately 7 seconds.

After the buzzer sounds 4 times, it sounds twice more. When the power back door does the opening operation the next time, the door will open to the initial settings position.

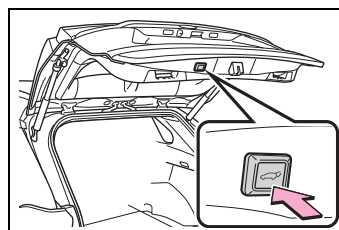

### Customization

The opening position can be set with the multi-information display. (→P.94)

Priority for the stop position is given to the last position set by either the power back door switch on the back door or multi-information display.

### Smart key system\*

\*: If equipped

The following operations can be performed simply by carrying the electronic key on your person, for example in your pocket. The driver should always carry the electronic key.

- Locks and unlocks the side doors (→P.108)
- Locks and unlocks the back door (→P.115)
- Starts the engine (→P.194)

#### ■ Antenna location

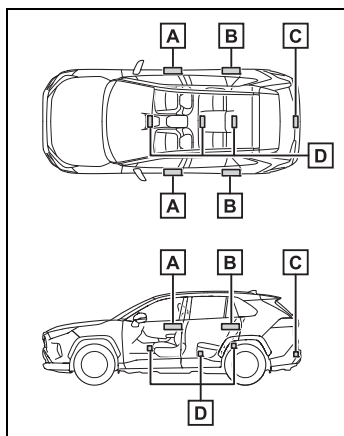

- A** Antennas outside the cabin (front)
- B** Antennas outside the cabin (rear) (if equipped)
- C** Antenna outside the luggage compartment
- D** Antennas inside the cabin

#### ■ Effective range (areas within which the electronic key is detected)

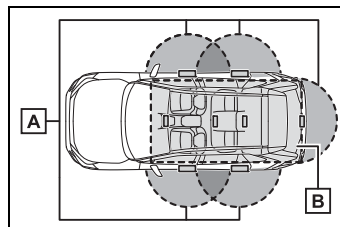

- A** When locking or unlocking the doors

The system can be operated when the electronic key is within about 2.3 ft. (0.7 m) of the front door handles, rear door handles (if equipped) and back door opener switch. (Only the doors detecting the key can be operated.)

- B** When starting the engine or changing engine switch modes

The system can be operated when the electronic key is inside the vehicle.

#### ■ If an alarm sounds or a warning message is displayed

An alarm sounds and warning message displays shown on the multi-information display are used to protect against unexpected accidents or theft of the vehicle resulting from erroneous operation. When a warning message is displayed, take appropriate measures based on the displayed message.

When only an alarm sounds, circumstances and correction procedures are as follows.



- When an exterior alarm sounds once for 5 seconds

Situation	Correction procedure
An attempt was made to lock the vehicle while a door was open.	Close all of the doors and lock the doors again.

- When an interior alarm pings continuously

Situation	Correction procedure
The engine switch was turned to ACC while the driver's door was open (or the driver's door was opened while the engine switch was in ACC).	Turn the engine switch to OFF and close the driver's door.

■ **Battery-saving function**



The battery-saving function will be activated in order to prevent the electronic key battery and the battery from being discharged while the vehicle is not in operation for a long time.

- In the following situations, the smart key system may take some time to unlock the doors.
  - The electronic key has been left in an area of approximately 6 ft. (2 m) of the outside of the vehicle for 10 minutes or longer.
  - The smart key system has not been used for 5 days or longer.
  - If the smart key system has not been used for 14 days or longer, the doors cannot be unlocked at any doors except the driver's door. In this case, take hold of the driver's door handle, or use the wireless remote control or the

mechanical key, to unlock the doors.

■ **Turning an electronic key to battery-saving mode**

- When battery-saving mode is set, battery depletion is minimized by stopping the electronic key from receiving radio waves.

Press  twice while pressing and holding .

Confirm that the electronic key indicator flashes 4 times.

While the battery-saving mode is set, the smart key system cannot be used. To cancel the function, press any of the electronic key buttons.

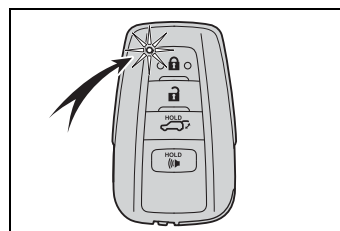

- Electronic keys that will not be used for long periods of time can be set to the battery-saving mode in advance.

■ **Conditions affecting operation**

The smart key system uses weak radio waves. In the following situations, the communication between the electronic key and the vehicle may be affected, preventing the smart key system, wireless remote control and engine immobilizer system from operating properly. (Ways of coping: →P.653)

- When the electronic key battery is depleted
- Near a TV tower, electric power plant, gas station, radio station, large display, airport or other facility that generates strong radio waves or electrical noise
- When the electronic key is in con-

tact with, or is covered by the following metallic objects

- Cards to which aluminum foil is attached
- Cigarette boxes that have aluminum foil inside
- Metallic wallets or bags
- Coins
- Hand warmers made of metal
- Media such as CDs and DVDs
- When other wireless key (that emits radio waves) is being used nearby
- When carrying the electronic key together with the following devices that emit radio waves
  - Portable radio, cellular phone, cordless phone or other wireless communication devices
  - Another vehicle's electronic key or a wireless key that emits radio waves
  - Personal computers or personal digital assistants (PDAs)
  - Digital audio players
  - Portable game systems
- If window tint with a metallic content or metallic objects are attached to the rear window
- When the electronic key is placed near a battery charger or electronic devices
- When parking in a coin-operated parking lot (Radio waves used to detect vehicles may affect the smart key system.)

■ **Note for the entry function**

- Even when the electronic key is within the effective range (detection areas), the system may not operate properly in the following cases:
  - The electronic key is too close to the window or outside door handle, near the ground, or in a high place when the doors are locked or unlocked.
  - The electronic key is on the instrument panel, luggage cover or floor, or in the door pockets or glove box when the engine is

started or engine switch modes are changed.

- Do not leave the electronic key on top of the instrument panel or near the door pockets when exiting the vehicle. Depending on the radio wave reception conditions, it may be detected by the antenna outside the cabin and the door will become lockable from the outside, possibly trapping the electronic key inside the vehicle.
- As long as the electronic key is within the effective range, the doors may be locked or unlocked by anyone. However, only the doors detecting the electronic key can be used to unlock the vehicle.
- Even if the electronic key is not inside the vehicle, it may be possible to start the engine if the electronic key is near the window.
- The doors may unlock if a large amount of water splashes on the door handle, such as in the rain or in a car wash when the electronic key is within the effective range. (The doors will automatically be locked after approximately 60 seconds if the doors are not opened and closed.)
- If the wireless remote control is used to lock the doors when the electronic key is near the vehicle, there is a possibility that the door may not be unlocked by the entry function. (Use the wireless remote control to unlock the doors.)
- Touching the door lock sensor while wearing gloves may delay or prevent lock operation. Remove the gloves and touch the lock sensor again.
- When the lock operation is performed using the lock sensor, recognition signals will be shown up to two consecutive times. After this, no recognition signals will be given.
- If the door handle becomes wet while the electronic key is within

the effective range, the door may lock and unlock repeatedly. In that case, follow the following correction procedures to wash the vehicle:

- Place the electronic key in a location 6 ft. (2 m) or more away from the vehicle. (Take care to ensure that the key is not stolen.)
- Set the electronic key to battery-saving mode to disable the smart key system. (→P.129)
- If the electronic key is inside the vehicle and a door handle becomes wet during a car wash, a message may be shown on the multi-information display and a buzzer will sound outside the vehicle. To turn off the alarm, lock all the doors.
- The lock sensor may not work properly if it comes into contact with ice, snow, mud, etc. Clean the lock sensor and attempt to operate it again, or use the lock sensor on the lower part of the door handle.
- A sudden approach to the effective range or door handle may prevent the doors from being unlocked. In this case, return the door handle to the original position and check that the doors unlock before pulling the door handle again.
- If there is another electronic key in the detection area, it may take slightly longer to unlock the doors after the door handle is gripped.

#### ■ When the vehicle is not driven for extended periods

- To prevent theft of the vehicle, do not leave the electronic key within 6 ft. (2 m) of the vehicle.
- The smart key system can be deactivated in advance. (→P.691)
- Battery-saving mode can reduce the power consumption of electronic keys. (→P.129)

#### ■ To operate the system properly

Make sure to carry the electronic key when operating the system. Do not get the electronic key too close to the vehicle when operating the system from the outside of the vehicle.

Depending on the position and holding condition of the electronic key, the key may not be detected correctly and the system may not operate properly. (The alarm may go off accidentally, or the door lock prevention may not operate.)

#### ■ If the smart key system does not operate properly

- Locking and unlocking the doors: Use the mechanical key. (→P.653)
- Starting the engine: →P.654

#### ■ Customization

Settings (e.g. smart key system) can be changed.  
(Customizable features: →P.691)

If the smart key system has been deactivated in a customized setting, refer to the explanations for the following operations.

- Locking and unlocking the doors: Use the wireless remote control or mechanical key. (→P.108, 653)
- Starting the engine and changing engine switch modes: →P.654
- Stopping the engine: →P.196

■ **Certification for the smart key system**

- ▶ For vehicles sold in the U.S.A., Hawaii, American Samoa, Guam, Saipan and Puerto Rico

FCC ID:NI4TMLF15-1

This device complies with part 15 of the FCC Rules. Operation is subject to the following two conditions: (1) This device may not cause harmful interference, and (2) this device must accept any interference received, including interference that may cause undesired operation.

Changes or modifications not expressly approved by the party responsible for compliance could void the user's authority to operate the equipment.

FCC ID:HYQ23AAY

FCC ID:HYQ14FBC

**NOTE:**

This device complies with part 15 of the FCC Rules. Operation is subject to the following two conditions: (1) This device may not cause harmful interference, and (2) this device must accept any interference received, including interference that may cause undesired operation.

**FCC WARNING:**

Changes or modifications not expressly approved by the party responsible for compliance could void the user's authority to operate the equipment.

- ▶ For vehicles sold in Canada

This device complies with Industry Canada's licence-exempt RSSs. Operation is subject to the following two conditions: (1) This device may not cause interference; and (2) This device must accept any interference, including interference that may cause undesired operation of the device.

Le présent appareil est conforme aux CNR d'Industrie Canada applicables aux appareils radio exempts de licence. L'exploitation est autorisée aux deux conditions suivantes : 1) l'appareil ne doit pas produire de brouillage; 2) l'utilisateur de l'appareil doit accepter tout brouillage radioélectrique subi, même si le brouillage est susceptible d'en compromettre le fonctionnement.

NOTE:  
This device complies with Industry Canada's licence-exempt RSSs.  
Operation is subject to the following two conditions:

- (1) This device may not cause interference; and
- (2) This device must accept any interference, including interference that may cause undesired operation of the device.

NOTE:  
Le présent appareil est conforme aux CNR d'Industrie Canada applicables aux appareils radio exempts de licence. L'exploitation est autorisée aux deux conditions suivantes:

- (1) l'appareil ne doit pas produire de brouillage;
- (2) l'utilisateur de l'appareil doit accepter tout brouillage radioélectrique subi, même si le brouillage est susceptible d'en compromettre le fonctionnement.

 **WARNING**

■ **Caution regarding interference with electronic devices**

- People with implantable cardiac pacemakers, cardiac resynchronization therapy-pacemakers or implantable cardioverter defibrillators should maintain a reasonable distance between themselves and the smart key system antennas. (→P.128)

The radio waves may affect the operation of such devices. If necessary, the entry function can be disabled. Ask your Toyota dealer for details, such as the frequency of radio waves and timing of the emitted radio waves. Then, consult your doctor to see if you should disable the entry function.

- Users of any electrical medical device other than implantable cardiac pacemakers, cardiac resynchronization therapy-pacemakers or implantable cardioverter defibrillators should consult the manufacturer of the device for information about its operation under the influence of radio waves. Radio waves could have unexpected effects on the operation of such medical devices.

Ask your Toyota dealer for details on disabling the entry function.

### Front seats

The seats can be adjusted (longitudinally, vertically, etc.). Adjust the seat to ensure the correct driving posture.

### Adjustment procedure

#### ► Manual seat

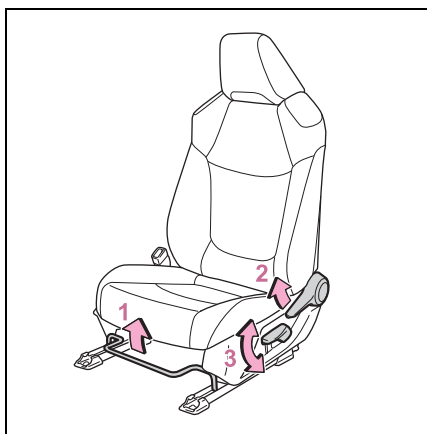

- 1 Seat position adjustment lever
- 2 Seatback angle adjustment lever
- 3 Vertical height adjustment lever (driver's side only)

#### ► Power seat (driver's side only)

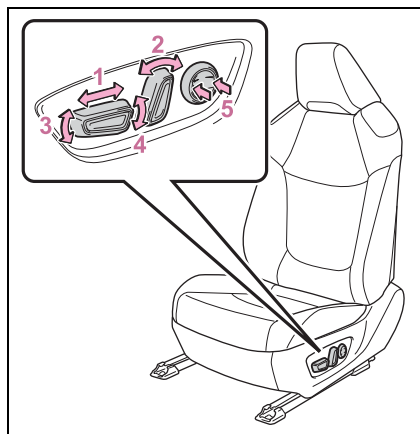

- 1 Seat position adjustment switch
- 2 Seatback angle adjustment switch
- 3 Seat cushion (front) angle adjustment switch
- 4 Vertical height adjustment switch
- 5 Lumbar support adjustment switch

#### ■ When adjusting the seat

Take care when adjusting the seat so that the head restraint does not touch the ceiling.

#### ⚠ WARNING

##### ■ When adjusting the seat position

- Take care when adjusting the seat position to ensure that other passengers are not injured by the moving seat.

**⚠ WARNING**

- Do not put your hands under the seat or near the moving parts to avoid injury. Fingers or hands may become jammed in the seat mechanism.
- Make sure to leave enough space around the feet so they do not get stuck.
- Manual seat only: After adjusting the seat, make sure that the seat is locked in position.

**■ Seat adjustment**

To reduce the risk of sliding under the lap belt during a collision, do not recline the seat more than necessary. If the seat is too reclined, the lap belt may slide past the hips and apply restraint forces directly to the abdomen, or your neck may contact the shoulder belt, increasing the risk of death or serious injury in the event of an accident. Adjustments should not be made while driving as the seat may unexpectedly move and cause the driver to lose control of the vehicle.

Rear seats

**Reclining adjustments and folding the seatbacks can be done with lever operation.**

**Adjustment procedure**

Pull the seatback angle adjustment lever **A**, and adjust the seatback angle.

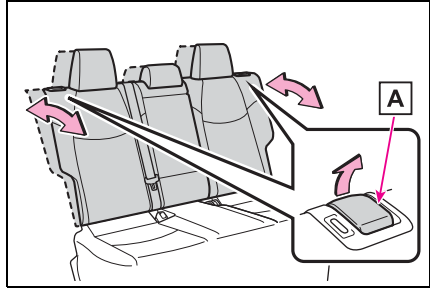

3

Before driving

**⚠ WARNING**

**■ When operating the seatback**

Observe the following precautions. Failure to do so may cause death or serious injury.

- Keep other passengers from being hit with the seatback.
- Do not bring your hands close to the moving parts or between the seats, as well as do not let any part of your body get caught.

**⚠ WARNING**

- After adjusting the seat, make sure that the seat is locked in position. If the seatback is not securely locked, the red marking will be visible. Make sure that the red marking is not visible.

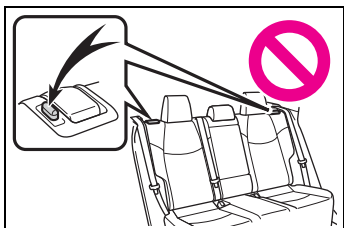

**Folding down the rear seatbacks**

■ **Before folding down the seatbacks**

- 1 Park the vehicle in a safe place.  
Apply the parking brake (→P.203) and shift the shift lever to P. (→P.200)
- 2 Adjust the position of the front seat and the angle of the seatback. (→P.134)  
Depending on the position of the front seat, if the seatback is folded backward, it may interfere with the operation of the rear seat.
- 3 Lift up and push down the head restraints of the rear outboard seats, and lower the head restraint of the rear center seat. (→P.140)
- 4 Stow the armrest of the rear seat if it is pulled out. (→P.547)

This step is not necessary when operating the left side seat only.

■ **Folding down the seatbacks**

While pulling the seatback angle adjustment lever **A**, fold the seatback down.

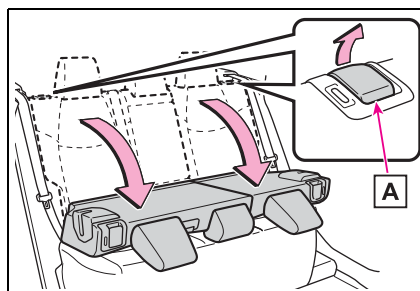

■ **Returning the rear seatbacks**

To avoid trapping the seat belt between the seat and the inside of the vehicle, pass the seat belt outside the seat belt guide **A** and then return the seatback securely to the locked position.

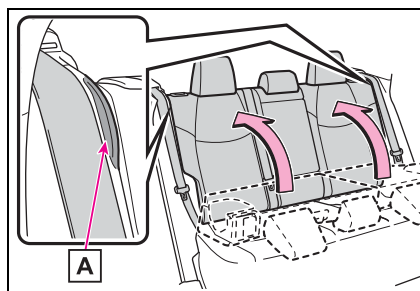

**⚠ WARNING**

Observe the following precautions. Failure to do so may result in death or serious injury.



**⚠ WARNING**

■ **When folding the rear seatbacks down**

- Do not fold the seatbacks down while driving.
- Stop the vehicle on level ground, set the parking brake and shift the shift lever to P.
- Do not allow anyone to sit on a folded seatback or in the luggage compartment while driving.
- Do not allow children to enter the luggage compartment.
- Do not operate the rear seat if it is occupied.
- Be careful not to get feet or hands caught in the moving parts or joints of the seats during operation.
- Do not allow children to operate the seat.

■ **After returning the rear seatback to the upright position**

- Make sure that the seatback is securely locked in position by lightly pushing it back and forth. If the seatback is not securely locked, the red marking will be visible. Make sure that the red marking is not visible.

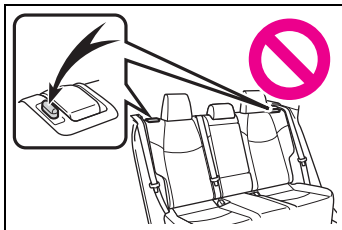

- Check that the seat belts are not twisted or caught in the seatback.

**Driving position memory\***

\*: If equipped

**This feature automatically adjusts the driver's seat to suit your preferences.**

**Your preferred driving position (the position of the driver's seat) can be recorded and recalled by pressing a button.**

**Two different driving positions can be recorded into memory.**

**Each electronic key can be registered to recall your preferred driving position.**

**Recording/recalling a driving position**

■ **Recording procedure**

- 1 Check that the shift lever is in P.
- 2 Turn the engine switch to ON.
- 3 Adjust the driver's seat to the desired positions.
- 4 While pressing the "SET" button, press button "1" or "2" until the buzzer sounds.

If the selected button has already been preset, the previously recorded position will be overwritten.

ten.

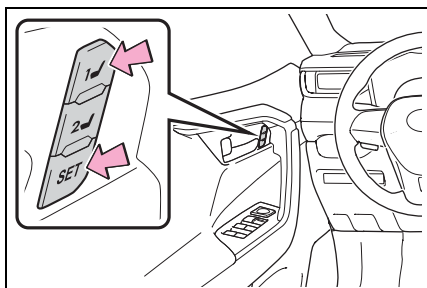

■ **Recall procedure**

- 1 Check that the shift lever is in P.
- 2 Turn the engine switch to ON.
- 3 Press one of the buttons for the driving position you want to recall until the buzzer sounds.

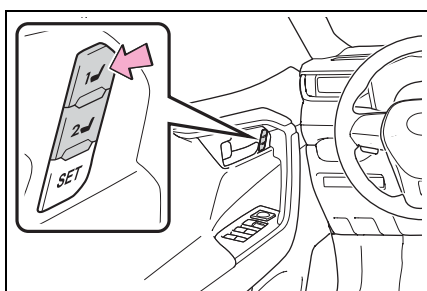

■ **To stop the position recall operation part-way through**

Perform any of the following:

- Press the "SET" button.
- Press button "1" or "2".
- Operate any of the seat adjustment switches.

■ **Seat positions that can be memorized (→P.134)**

The adjusted positions other than the position adjusted by lumbar support switch can be recorded.

■ **Operating the driving position memory after turning the engine switch to OFF**

Recorded seat positions can be activated up to 180 seconds after the driver's door is opened and another 60 seconds after it is closed again.

■ **In order to correctly use the driving position memory function**

If a seat position is already in the furthest possible position and the seat is operated in the same direction, the recorded position may be slightly different when it is recalled.

■ **When recalling the driving position**

Take care when recalling the driving position so that the head restraint does not touch the ceiling.

■ **If the battery is disconnected**

The memorized positions are erased.

**⚠ WARNING**

■ **Seat adjustment caution**

Take care during seat adjustment so that the seat does not strike the rear passenger or squeeze your body against the steering wheel.

**Registering/recall/canceling a driving position to an electronic key (memory recall function)**

■ **Registering procedure**

Record your driving position to button "1" or "2" before performing the following:

Carry only the key you want to register, and then close the

driver's door.

If 2 or more keys are in the vehicle, the driving position cannot be recorded properly.

- 1 Check that the shift lever is in P.
- 2 Turn the engine switch to ON.
- 3 Recall the driving position that you want to record.
- 4 While pressing the recalled button, press and hold the door lock switch (either lock or unlock) until the buzzer sounds.

If the button could not be registered, the buzzer sounds continuously for approximately 3 seconds.

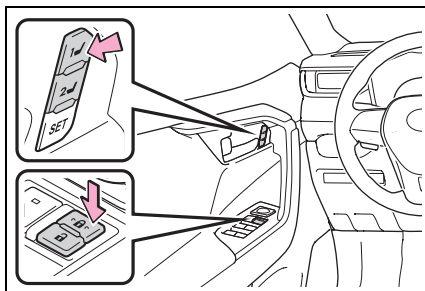

■ **Recall procedure**

Make sure that the doors are locked before recalling the driving position. Carry the electronic key that has been registered to the driving position, and then unlock and open the driver's door using the smart key system or wireless remote control.

The driving position will move to the recorded position.

If the driving position is in a position

that has already been recorded, the seat will not move.

■ **Cancelation procedure**

Carry only the key you want to cancel and then close the driver's door.

If 2 or more keys are in the vehicle, the driving position cannot be canceled properly.

- 1 Check that the shift lever is in P.
- 2 Turn the engine switch to ON.
- 3 While pressing the "SET" button, press and hold the door lock switch (either lock or unlock) until the buzzer sounds twice.

If the button could not be canceled, the buzzer sounds continuously for approximately 3 seconds.

■ **Recalling the driving position using the memory recall function**

- Different driving positions can be registered for each electronic key. Therefore, the driving position that is recalled may be different depending on the key being carried.
- If a door other than the driver's door is unlocked with smart key system, the driving position cannot be recalled. In this case, press the driving position button which has been set.

■ **Customization**

Settings (e.g. the unlock door settings of the memory recall function) can be customized. (Customizable features: →P.693)

## Head restraints

**Head restraints are provided for all seats.**

### WARNING

#### ■ Head restraint precautions

Observe the following precautions regarding the head restraints. Failure to do so may result in death or serious injury.

- Use the head restraints designed for each respective seat.
- Adjust the head restraints to the correct position at all times.
- After adjusting the head restraints, push down on them and make sure they are locked in position.
- Do not drive with the head restraints removed.

## Vertical adjustment

### ■ Front seats

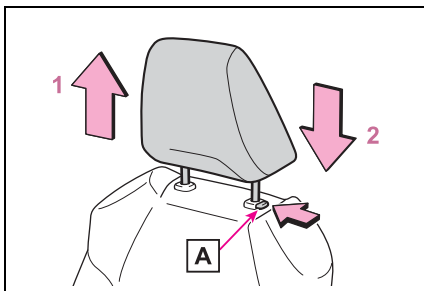

#### 1 Up

Pull the head restraints up.

#### 2 Down

Push the head restraint down while pressing the lock release button

**A**.

### ■ Center rear seat

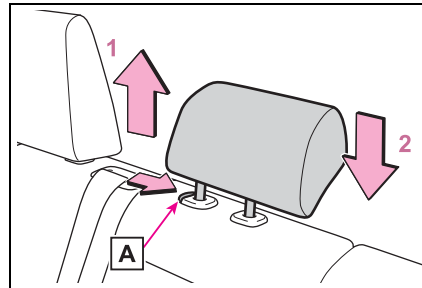

#### 1 Up

Pull the head restraints up.

#### 2 Down

Push the head restraint down while pressing the lock release button

**A**.

### ■ Outboard rear seats

Head restraints cannot be adjusted.

### ■ Adjusting the height of the head restraints (front seats)

Make sure that the head restraints are adjusted so that the center of the head restraint is closest to the top of your ears.

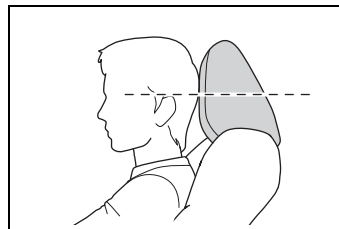

### ■ Adjusting the center rear seat head restraint

Always raise the head restraint one level from the stowed position when using.

### Removing the head restraints

Pull the head restraint up while pressing the lock release button

**A**.

If the head restraint touches the ceiling, making the removal difficult, change the seat height or angle. (→P.134)

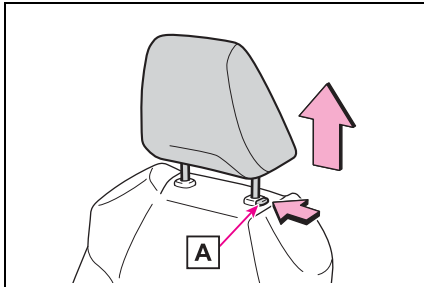

### ■ Outboard rear seats

Align the head restraint with the installation holes and push it down to the lowest lock position.

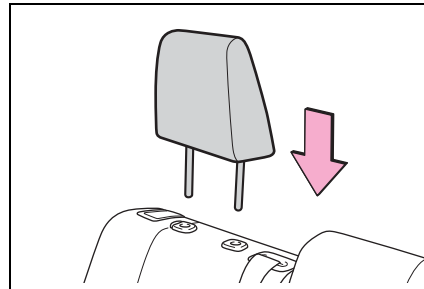

### Installing the head restraints

#### ■ Front and center rear seats

Align the head restraint with the installation holes and push it down to the lock position.

Press and hold the lock release button **A** when lowering the head restraint.

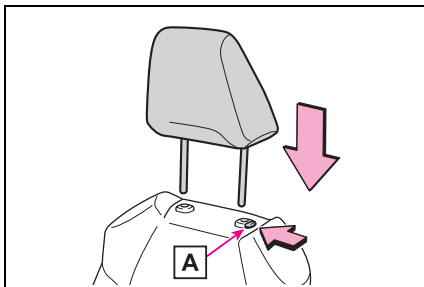

3

Before driving

### Steering wheel

#### Adjustment procedure

- 1 Hold the steering wheel and push the lever down.

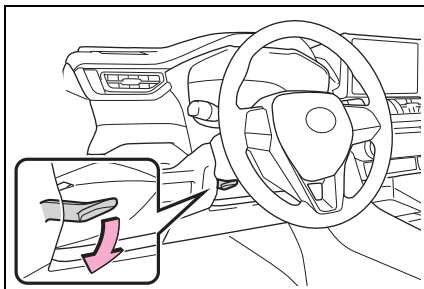

- 2 Adjust to the ideal position by moving the steering wheel horizontally and vertically.

After adjustment, pull the lever up to secure the steering wheel.

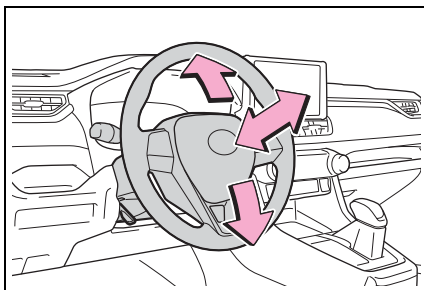

#### WARNING

##### ■ Caution while driving

Do not adjust the steering wheel while driving. Doing so may cause the driver to mishandle the vehicle and cause an accident, resulting in death or serious injury.

##### ■ After adjusting the steering wheel

Make sure that the steering wheel is securely locked. Otherwise, the steering wheel may move suddenly, possibly causing an accident, and resulting in death or serious injury. Also, the horn may not sound if the steering wheel is not securely locked.

#### Sounding the horn

To sound the horn, press on or close to the  mark.

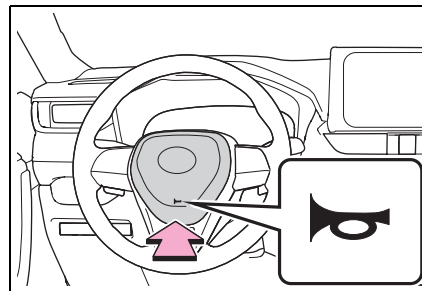

**Inside rear view mirror\***

\*: If equipped

**The rear view mirror's position can be adjusted to enable sufficient confirmation of the rear view.**

**Adjusting the height of rear view mirror**

The height of the rear view mirror can be adjusted to suit your driving posture.

Adjust the height of the rear view mirror by moving it up and down.

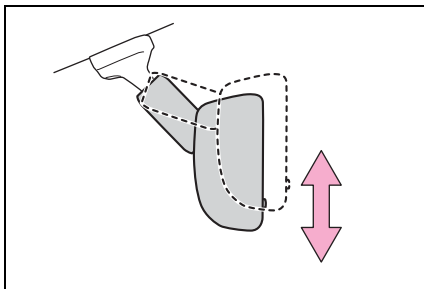

**⚠ WARNING**

**■ Caution while driving**

Do not adjust the position of the mirror while driving. Doing so may lead to mishandling of the vehicle and cause an accident, resulting in death or serious injury.

**Anti-glare function (vehicles with manual anti-glare inside rear view mirror)**

Reflected light from the headlights of vehicles behind can be reduced by operating the lever.

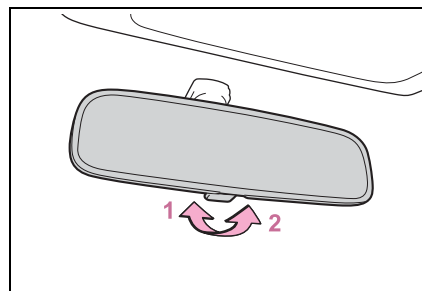

- 1 Normal position
- 2 Anti-glare position

**Anti-glare function (vehicles with auto anti-glare inside rear view mirror)**

Responding to the level of brightness of the headlights of vehicles behind, the reflected light is automatically reduced.

Changing automatic anti-glare function mode on/off

When the automatic anti-glare function is in ON mode, the indicator **A** illuminates.

The function will set to ON mode each time the engine switch is turned to ON.

Pressing the button turns the function to OFF mode. (The indicator

**A** also turns off.)

**3** Before driving

- ▶ Vehicles without garage door opener

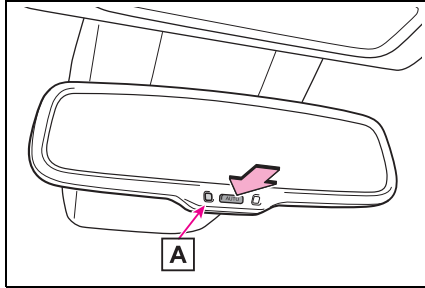

- ▶ Vehicles with garage door opener

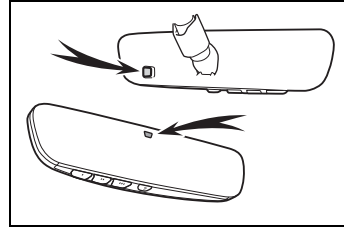

- ▶ Vehicles with garage door opener

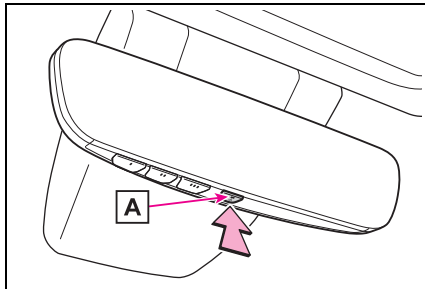

■ To prevent sensor error (vehicles with auto anti-glare inside rear view mirror)

To ensure that the sensors operate properly, do not touch or cover them.

- ▶ Vehicles without garage door opener

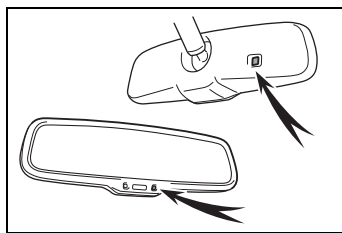



## Digital Rear-view Mirror\*

\*: If equipped

**The Digital Rear-view Mirror is a system that uses the camera on the rear of the vehicle and displays its image on the display of the Digital Rear-view Mirror.**

**The Digital Rear-view Mirror can be changed between optical mirror mode and digital mirror mode by operating the lever.**

**The Digital Rear-view Mirror allows the driver to see the rear view despite obstructions, such as the head restraints or luggage, ensuring rear visibility. Also, the rear seats are not displayed and privacy of the passengers is enhanced.**

### WARNING

Observe the following precautions.

Failure to do so may result in death or serious injury.

#### ■ Before using the Digital Rear-view Mirror

- Make sure to adjust the mirror before driving. (→P.147)
- Change to optical mirror mode and adjust the position of the Digital Rear-view Mirror so that the area behind your vehicle can be viewed properly.

- Change to digital mirror mode and adjust the display settings.

- As the range of the image displayed by the Digital Rear-view Mirror is different from that of the optical mirror, make sure to check this difference before driving.

### System components

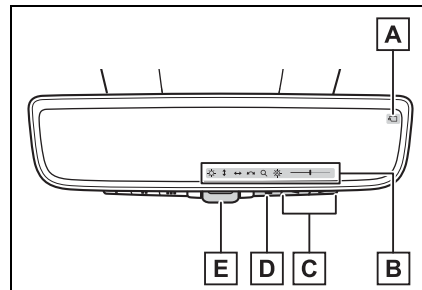

#### **A** Camera indicator

Indicates that the camera is operating normally.

#### **B** Icon display area

Displays icons, adjusting gauge, etc. (→P.147)

#### **C** Select button

Press to change the setting of the item you want to adjust.

#### **D** Menu button

Press to display the icon display area and select the item you want to adjust.

#### **E** Lever

Operate to change between digital mirror mode and optical mirror mode.

3

Before driving

### Changing modes

Operate the lever to change between digital mirror mode and optical mirror mode.

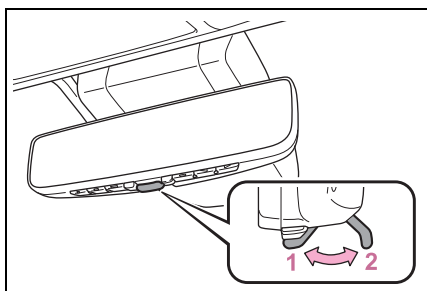

#### 1 Digital mirror mode

Displays an image of the area behind the vehicle.

 will illuminate in this mode.

#### 2 Optical mirror mode

Turns off the display of the Digital Rear-view Mirror allows it to be used as an optical mirror.

#### ■ Digital mirror mode operating condition

The engine switch is turned to ON. When the engine switch is changed from ON to OFF or ACC, the image will disappear after several seconds.

#### ■ When using the Digital Rear-view Mirror in digital mirror mode

- If it is difficult to see the displayed image due to light reflected off the Digital Rear-view Mirror, the camera being dirty, or if lights of a vehicle behind your vehicle or the displayed image are bothering you, change to optical mirror mode.
- When the back door is open, the Digital Rear-view Mirror image may not display properly. Before driving, make sure the back door

is closed.

- If the display is difficult to see due to reflected light, close the sunshade for the moon roof (if equipped) or the electronic sunshade for the panoramic moon roof (if equipped).
- Any of the following conditions may occur when driving in the dark, such as at night. None of them indicates that a malfunction has occurred.
  - Colors of objects in the displayed image may differ from their actual color.
  - Depending on the height of the lights of the vehicle behind, the area around the vehicle may appear white and blurry.
  - Automatic image adjustment for brighter surrounding image may cause flickering.
- If it is difficult to see the displayed image or flickering bothers you, change to optical mirror mode.
- The Digital Rear-view Mirror may become hot while it is in digital mirror mode. This is not a malfunction.
- Depending on your physical condition or age, it may take longer than usual to focus on the displayed image. In this case, change to optical mirror mode.
- Do not let passengers stare at the displayed image when the vehicle is being driven, as doing so may cause motion sickness.

#### ■ When the system malfunctions

If the symbol shown in the illustration is displayed when using the Digital Rear-view Mirror in digital mirror mode, the system may be malfunctioning. The symbol will disappear in a few seconds. Operate the lever, change to optical mirror mode and have the vehicle inspected by your Toyota dealer.

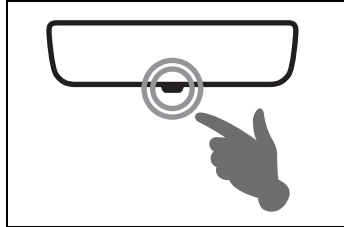

**Adjusting the mirror**

■ **Adjusting the mirror height**

The height of the rear view mirror can be adjusted to suit your driving posture.

Change to optical mirror mode, adjusting the height of the rear view mirror by moving it up and down.

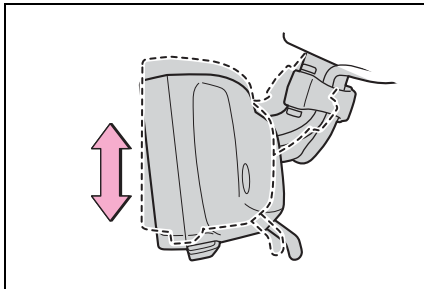

■ **Display settings (digital mirror mode)**

Settings of the display in the digital mirror mode, on/off operation of the automatic anti-glare function, etc. can be changed.

- 1 Press the menu button.

The icons will be displayed.

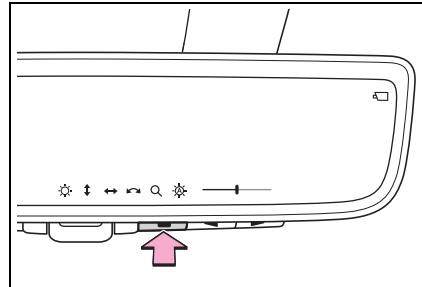

- 2 Press the menu button repeatedly and select the item you want to adjust.

- 3 Press or to change the setting.

The icons will disappear if a button is not operated for approximately 5 seconds or more.

Icons	Settings
	Select to adjust the brightness of the display.
	Select to adjust the area displayed up/down.
	Select to adjust the area displayed to the left/right.
	Select to adjust the angle of the displayed image.

3

Before driving

Icons	Settings
Q	Select to zoom in/out the displayed image.
	<p>Select to enable/disable the automatic anti-glare function.*</p> <p>Responding to the brightness of the headlights of vehicles behind, the reflected light is automatically adjusted.</p> <p>The automatic anti-glare function is enabled each time the engine switch is changed to ON.</p>

\*: This is a function for the optical mirror mode, however, the setting can also be changed while using the digital mirror mode.

**■ Enabling/disabling the automatic anti-glare function (optical mirror mode)**

The automatic anti-glare function in the optical mirror mode can be enabled/disabled. The setting can be changed in both the digital mirror mode and the optical mirror mode.

- ▶ When using the digital mirror mode

→P.147

- ▶ When using the optical mirror mode

1 Press the menu button.

The icons will be displayed.

- 2 Press the menu button repeatedly and select

The setting display will be displayed.

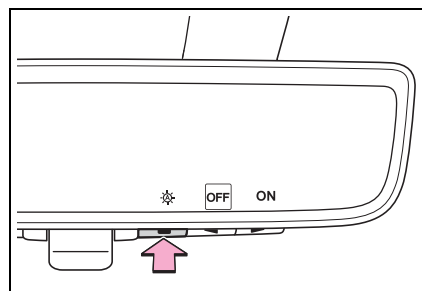

- 3 Press or to enable (ON)/disable (OFF) the automatic anti-glare function.

The icons will disappear if a button is not operated for approximately 5 seconds or more.

**■ Adjusting the display (digital mirror mode)**

- If the displayed image is adjusted, it may appear distorted. This is not a malfunction.
- If the brightness of the Digital Rear-view Mirror is set too high, it may cause eye strain. Adjust the Digital Rear-view Mirror to an appropriate brightness. If your eyes become tired, change to optical mirror mode.
- The brightness of the Digital Rear-view Mirror will change automatically according to the brightness of the area in front of your vehicle.

**■ To prevent the light sensors from malfunctioning**

To prevent the light sensors from malfunctioning, do not touch or cover them.

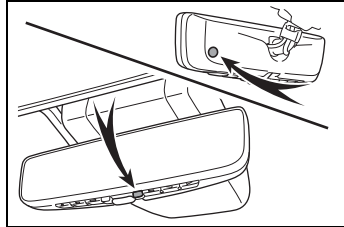

**⚠ WARNING**

Observe the following precautions. Failure to do so may result in death or serious injury.

■ **While driving**

- Do not adjust the position of the Digital Rear-view Mirror or adjust the display settings while driving. Stop the vehicle and operate the Digital Rear-view Mirror control switches. Failure to do so may cause a steering wheel operation error, resulting in an unexpected accident.

- Always pay attention to the vehicle's surroundings.

The size of the vehicles and other objects may look different when in digital mirror mode and optical mirror mode.

When backing up, make sure to directly check the safety of the area around your vehicle, especially behind the vehicle. Additionally, if a vehicle approaches from the rear in the dark, such as at night, the surrounding area may appear dim.

■ **To prevent causes of fire**

If the driver continues using the Digital Rear-view Mirror while smoke or odor comes from the mirror, it may result in fire. Stop using the system immediately and contact your Toyota dealer.

**Cleaning the Digital Rear-view Mirror**

■ **Cleaning the mirror surface**

If the mirror surface is dirty, the image on the display may be difficult to see.

Clean the mirror surface gently using a soft dry cloth.

■ **Cleaning the camera**

If the camera lens is dirty, the displayed image may not be clear. In this case, clean it with a soft cloth dampened with water or a swab.

■ **The camera**

The camera for the Digital Rear-view Mirror is located as shown.

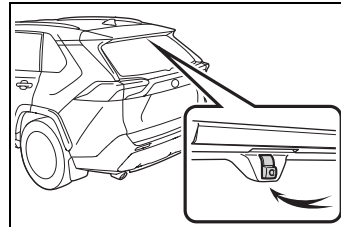

**NOTICE****■ To prevent the Digital Rear-view Mirror from malfunctioning**

- Do not use detergents, such as thinner, benzene, and alcohol to clean the mirror. They may discolor, deteriorate or damage the mirror surface.
- Do not smoke, use matches, use cigarette lighters or allow open flames near the mirror. It may damage the mirror or cause a fire.
- Do not remove, disassemble or modify the mirror.

**■ To prevent the camera from malfunctioning**

- Observe the following precautions, otherwise the Digital Rear-view Mirror may not operate properly.
- Do not strike or hit the camera or subject it to a strong impact, as the camera installation position and angle may be changed.

- Do not remove, disassemble or modify the camera.
- Do not allow an organic solvent, car wax, window cleaner or glass coating to adhere to the camera. If this happens, wipe it off as soon as possible.
- When cleaning the camera lens, wipe the camera lens with a damp soft cloth. Do not strongly rub the camera lens, as it may be scratched and will not be able to transmit a clear image.
- When applying colored film (including transparent film) to the rear window glass, do not apply it to the area in front of the camera. If film is applied to the area in front of the camera, the image from the camera may not display properly.
- Do not subject the camera to a strong impact as this could cause a malfunction. If this happens, have the vehicle inspected by your Toyota dealer as soon as possible.

**If you notice any symptoms**



If you notice any of the following symptoms, refer to the following table for the likely cause and the solution.

If the symptom is not resolved by the solution, have the vehicle inspected by your Toyota dealer.



Symptom	Likely cause	Solution
The image is difficult to see.	The mirror surface is dirty.	Clean the mirror surface gently, using a soft dry cloth.
	Sunlight or headlights are shining directly into the Digital Rear-view Mirror.	Change to optical mirror mode. (If the light is coming through the moon roof [if equipped] or panoramic moon roof [if equipped], close the sunshade or electronic sunshade.)
	<ul style="list-style-type: none"> <li>• The vehicle is in a dark area.</li> <li>• The vehicle is near a TV tower, broadcasting station, electric power plant, or other location where strong radio waves or electrical noise may be present.</li> <li>• The temperature around the camera is extremely high/low.</li> <li>• The ambient temperature is extremely low.</li> <li>• It is raining or humid.</li> <li>• Sunlight or headlights are shining directly into the camera lens.</li> <li>• The vehicle is under fluorescent lights, sodium lights, mercury lights, etc.</li> <li>• Exhaust gas is obstructing the camera.</li> </ul>	Change to optical mirror mode. (Change back to digital mirror mode when the conditions have improved.)

3

Before driving

Symptom	Likely cause	Solution
The image is difficult to see.	The luggage in the luggage compartment is reflected off the rear window glass and obstructing the camera.	<ul style="list-style-type: none"> <li>• Change to optical mirror mode.</li> <li>• Move the luggage to a position where it does not obstruct the camera or cover it with a black cloth to reduce the amount it is reflected off the rear window glass.</li> </ul>
	The rear window glass is fogged up.	Change to optical mirror mode. After defogging the rear window using the rear window defogger (→P.517), use the digital mirror mode again.
	The outside of the rear window glass is dirty.	Use the rear window wiper to remove dirt.
	The inside of the rear window glass is dirty.	Wipe the inside of rear window glass with a damp soft cloth.
The image is out of alignment.	The back door is not fully closed.	Fully close the back door.
	The camera or its surrounding area has received a strong impact.	Change to optical mirror mode and have the vehicle inspected by your Toyota dealer.
The display is dim and  is displayed.	The system may be malfunctioning.	Change to optical mirror mode and have the vehicle inspected by your Toyota dealer.
 goes off.		



Symptom	Likely cause	Solution
 is displayed.	The Digital Rear-view Mirror is extremely hot. (The display will gradually become more dim. If the temperature continues to increase, the Digital Rear-view Mirror will turn off.)	Reducing the cabin temperature is recommended to reduce the temperature of the mirror. (  will disappear when the mirror becomes cool.)  If  does not disappear even though the mirror is cool, have the vehicle inspected by your Toyota dealer.
The lever cannot be operated properly.	The lever may be malfunctioning.	Change to optical mirror mode and have the vehicle inspected by your Toyota dealer. (To change to optical mirror mode, press and hold the menu button for approximately 10 seconds.)

### Outside rear view mirrors

**The rear view mirror's position can be adjusted to enable sufficient confirmation of the rear view.**

#### ■ Defogging the mirrors (if equipped)

The outside rear view mirrors can be cleared using the mirror defoggers. Turn on the rear window defogger to turn on the outside rear view mirror defoggers. (→P.511, 517)

#### ⚠ WARNING

##### ■ Important points while driving

Observe the following precautions while driving. Failing to do so may result in loss of control of the vehicle and cause an accident, resulting in death or serious injury.

- Do not adjust the mirrors while driving.
- Do not drive with the mirrors folded.
- Both the driver and passenger side mirrors must be extended and properly adjusted before driving.

##### ■ When the mirror defoggers are operating (if equipped)

Do not touch the rear view mirror surfaces, as they can become very hot and burn you.

### Adjustment procedure

- 1 To select a mirror to adjust, press the switch.

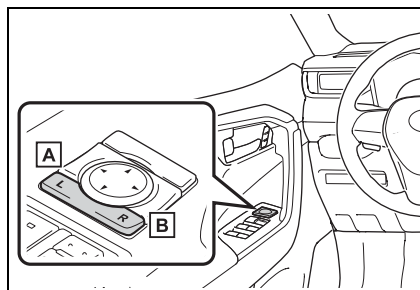

A Left

B Right

- 2 To adjust the mirror, press the switch.

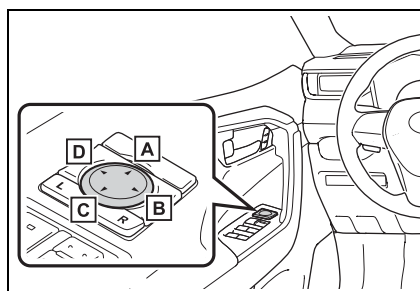

A Up

B Right

C Down

D Left

#### ■ Mirror angle can be adjusted when

The engine switch is in ACC or ON.

### Folding the mirrors

Push the mirror back in the direction of the vehicle's rear.

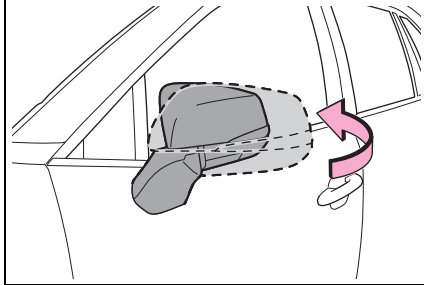

**⚠ WARNING**

**■ When a mirror is moving**

To avoid personal injury and mirror malfunction, be careful not to get your hand caught by the moving mirror.

## Power windows

### Opening and closing the power windows

The power windows can be opened and closed using the switches.

Operating the switch moves the side windows as follows:

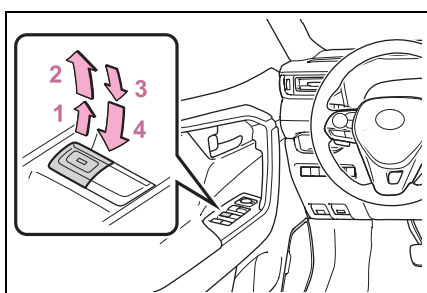

- 1 Closing
- 2 One-touch closing\*
- 3 Opening
- 4 One-touch opening\*

\*: To stop the side window partway, operate the switch in the opposite direction.

#### ■ The power windows can be operated when

The engine switch is in ON.

#### ■ Operating the power windows after turning the engine off

The power windows can be operated for approximately 45 seconds even after the engine switch is turned to ACC or OFF. They cannot, however, be operated once either front door is opened.

#### ■ Jam protection function

If an object becomes jammed between the side window and the

window frame while the side window is closing, side window movement is stopped and the side window is opened slightly.

#### ■ Catch protection function

If an object becomes caught between the door and side window while the side window is opening, side window movement is stopped.

#### ■ When the power window cannot be opened or closed

When the jam protection function or catch protection function operates unusually and the side window cannot be opened and closed, perform the following operations with the power window switch of that door.

- Stop the vehicle. With the engine switch in ON, within 4 seconds of the jam protection function or catch protection function activating, continuously operate the power window switch in the one-touch closing direction or one-touch opening direction so that the side window can be opened and closed.
- If the side window cannot be opened and closed even when performing the above operations, perform the following procedure for function initialization.
  - 1 Turn the engine switch to ON.
  - 2 Pull and hold the power window switch in the one-touch closing direction and completely close the side window.
  - 3 Release the power window switch for a moment, resume pulling the switch in the one-touch closing direction, and hold it there for approximately 6 seconds or more.
  - 4 Press and hold the power window switch in the one-touch opening direction. After the side window is completely opened, continue holding the switch for an additional 1 second or more.

- 5 Release the power window switch for a moment, resume pushing the switch in the one-touch opening direction, and hold it there for approximately 4 seconds or more.
- 6 Pull and hold the power window switch in the one-touch closing direction again. After the side window is completely closed, continue holding the switch for a further 1 second or more.

If you release the switch while the side window is moving, start again from the beginning.

If the side window reverses and cannot be fully closed or opened, have the vehicle inspected by your Toyota dealer.

■ **Door lock linked power window operation**

- The power windows can be opened and closed using the key (vehicles without smart key system) or mechanical key (vehicles with smart key system).\* (→P.109, 654)
- The power windows can be opened using the wireless remote control.\* (→P.108)
- Vehicles with alarm: The alarm may be triggered if the alarm is set and the power window is closed using the door lock linked power window operation function. (→P.73)

\*: These settings must be customized at your Toyota dealer.

■ **Power window open reminder function**

▶ Vehicles without smart key system  
The buzzer sounds and a message is shown on the multi-information display when the key has been removed from the engine switch and the driver's door is opened with the power windows open.

▶ Vehicles with smart key system  
The buzzer sounds and a message is shown on the multi-information display when the engine switch is turned to OFF and the driver's door is opened with the power windows open.

■ **Customization**

Settings (e.g. linked door lock operation) can be changed. (Customizable features: →P.693)

**! WARNING**

Observe the following precautions. Failing to do so may result in death or serious injury.

■ **Closing the power windows**

- The driver is responsible for all the power window operations, including the operation for the passengers. In order to prevent accidental operation, especially by a child, do not let a child operate the power windows. It is possible for children and other passengers to have body parts caught in the power window. Also, when riding with a child, it is recommended to use the window lock switch. (→P.158)
- Check to make sure that all passengers do not have any part of their body in a position where it could be caught when a power window is being operated.

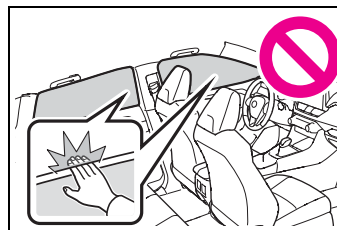

**⚠ WARNING**

- When using the wireless remote control, key or mechanical key and operating the power windows, operate the power window after checking to make sure that there is no possibility of any passenger having any of their body parts caught in the side window. Also, do not let a child operate the power window by the wireless remote control, key or mechanical key. It is possible for children and other passengers to get caught in the power window.
  - When exiting the vehicle, turn the engine switch to OFF, carry the key and exit the vehicle along with the child. There may be accidental operation, due to mischief, etc., that may possibly lead to an accident.
- **Jam protection function**
- Never use any part of your body to intentionally activate the jam protection function.
  - The jam protection function may not work if something gets jammed just before the side window is fully closed. Be careful not to get any part of your body jammed in the side window.
- **Catch protection function**
- Never use any part of your body or clothing to intentionally activate the catch protection function.
  - The catch protection function may not work if something gets caught just before the side window is fully opened. Be careful not to get any part of your body or clothing caught in the side window.

**Preventing accidental operation (window lock switch)**

This function can be used to prevent children from accidentally opening or closing a passenger window.

Press the switch.

The indicator **A** will come on and the passenger windows will be locked.

The passenger windows can still be opened and closed using the driver's switch even if the lock switch is on.

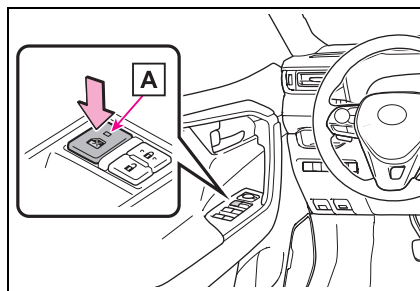
**■ The window lock switch can be operated when**

The engine switch is in ON.

**■ When the battery is disconnected**

The window lock switch is disabled. If necessary, press the window lock switch after reconnecting the battery.

**Moon roof\***

\*: If equipped

**Use the overhead switches to open and close the moon roof and tilt it up and down.**

**Operating the moon roof**

■ **Opening and closing**

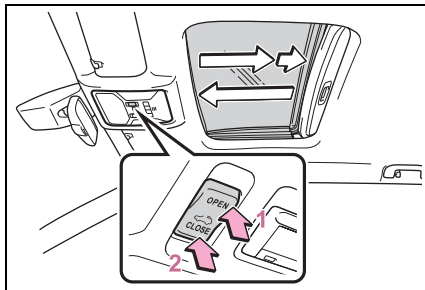

**1** Opens the moon roof\*

The moon roof stops slightly before the fully open position to reduce wind noise.

Press the switch again to fully open the moon roof.

**2** Closes the moon roof\*

\*: Lightly press either side of the moon roof switch to stop the moon roof partway.

■ **Tilting up and down**

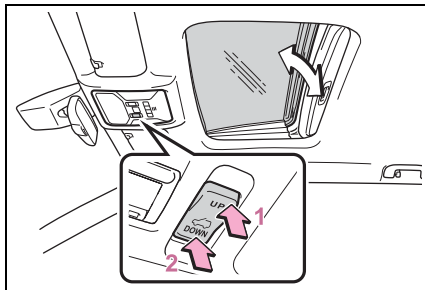

**1** Tilts the moon roof up\*

**2** Tilts the moon roof down\*

\*: Lightly press either side of the moon roof switch to stop the moon roof partway.

■ **The moon roof can be operated when**

The engine switch is in ON.

■ **Operating the moon roof after turning the engine off**

The moon roof can be operated for approximately 45 seconds after the engine switch is turned to ACC or OFF. It cannot, however, be operated once either front door is opened.

■ **Jam protection function**

If an object is detected between the moon roof and the frame while the moon roof is closing or tilting down, travel is stopped and the moon roof opens slightly.

■ **Sunshade**

The sunshade can be opened and closed manually. However, the sunshade will open automatically when the moon roof is opened.

■ **Door lock linked moon roof operation**

● The moon roof can be opened and closed using the mechanical key.\* (→P.654)

● The moon roof can be opened using the wireless remote control.\* (→P.108)

● Vehicles with alarm: The alarm may be triggered if the alarm is set and the moon roof is closed using the door lock linked moon roof operation function. (→P.73)

\*: These settings must be customized at your Toyota dealer.

■ **When the moon roof does not close normally**

Perform the following procedure:

- 1 Stop the vehicle.
- 2 Press and hold the “CLOSE” switch.\*

The moon roof will close, reopen and pause for approximately 10 seconds. Then it will close again and stop at the completely closed position.

- 3 Check to make sure that the moon roof is completely closed and then release the switch.

\*: If the switch is released at the incorrect time, the procedure will have to be performed again from the beginning.

If the moon roof does not fully close even after performing the above procedure correctly, have the vehicle inspected by your Toyota dealer.

■ **If the moon roof does not move normally**

If the moon roof does not open or close normally or the automatic opening function does not operate, perform the following initialization procedure.

- 1 Stop the vehicle.
- 2 Press and hold the “DOWN” switch.\*

The moon roof will stop at the tilt-up position. After that, it will open, close, tilt up, tilt down, and stop at the fully closed position.

- 3 Confirm that the moon roof has completely stopped and release the switch.

\*: If you release the switch while the moon roof is moving, perform the procedure again from the beginning.

If, after performing the above procedures correctly, the moon roof still does not open or close normally or

the automatic opening function does not operate, have the vehicle inspected by your Toyota dealer.

■ **Moon roof open reminder function**

The buzzer sounds and a message is shown on the multi-information display when the engine switch is turned to OFF and the driver's door is opened with the moon roof open.

■ **Customization**

Settings (e.g. linked door lock operation) can be changed. (Customizable features: →P.693)

 **WARNING**

Observe the following precautions.

Failure to do so may cause death or serious injury.

■ **Opening the moon roof**

● Do not allow any passengers to put their hands or head outside the vehicle while it is moving.

● Do not sit on top of the moon roof.

■ **Opening and closing the moon roof**

● The driver is responsible for moon roof opening and closing operations.

In order to prevent accidental operation, especially by a child, do not let a child operate the moon roof. It is possible for children and other passengers to have body parts caught in the moon roof.



**⚠ WARNING**

- Check to make sure that all passengers do not have any part of their body in a position where it could be caught when the moon roof is being operated.

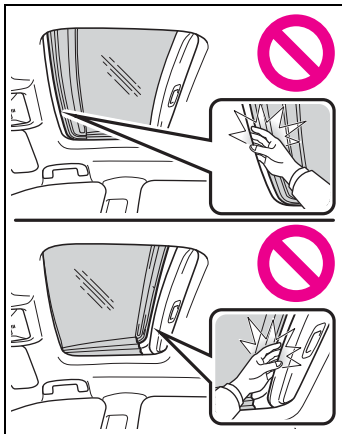

- When using the wireless remote control or mechanical key and operating the moon roof, operate the moon roof after checking to make sure that there is no possibility of any passenger having any of their body parts caught in the moon roof. Also, do not let a child operate moon roof by the wireless remote control or mechanical key. It is possible for children and other passengers to get caught in the moon roof.
  - When exiting the vehicle, turn the engine switch to OFF, carry the key and exit the vehicle along with the child. There may be accidental operation, due to mischief, etc., that may possibly lead to an accident.
- **Jam protection function**
- Never use any part of your body to intentionally activate the jam protection function.

- The jam protection function may not work if something gets caught just before the moon roof is fully closed. Also, the jam protection function is not designed to operate while the switch is being pressed. Take care so that your fingers, etc. do not get caught.

**Panoramic moon roof\***

\*: If equipped

**Use the overhead switches to operate the panoramic moon roof and electronic sunshade.**

**Operating the electronic sunshade and panoramic moon roof**

■ **Opening and closing the electronic sunshade**

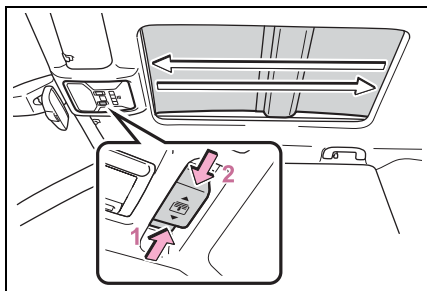

1 Opens the electronic sunshade\*

Slide and hold the  switch backward. The electronic sunshade will fully open automatically.

2 Closes the electronic sunshade\*

Slide and hold the  switch forward. The electronic sunshade will fully close automatically.

If the panoramic moon roof is not fully closed, it will close fully before the electronic sunshade closes.

\*: Quickly slide and release the

 switch in either direction to stop the electronic sunshade partway.

■ **Tilting the panoramic moon roof up and down**

Press the  switch to tilt the panoramic moon roof up.\*

When the panoramic moon roof is tilted up, the electronic sunshade will open to the half-open position of the roof.

\*: Lightly press the  switch again to stop the panoramic moon roof partway.

Press and hold the  switch to tilt the panoramic moon roof down.

The panoramic moon roof can be tilted down only when it is in the tilt-up position.

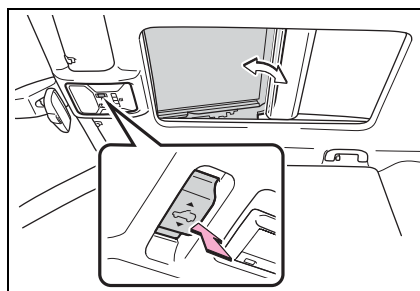

■ **Opening and closing the panoramic moon roof**

Opens the panoramic moon roof\*

Slide and hold the  switch

backward. The panoramic moon roof and electronic sunshade will open automatically.

The panoramic moon roof can be opened from the tilt-up position.

\*: Quickly slide and release the  switch in either direction to stop the panoramic moon roof partway.

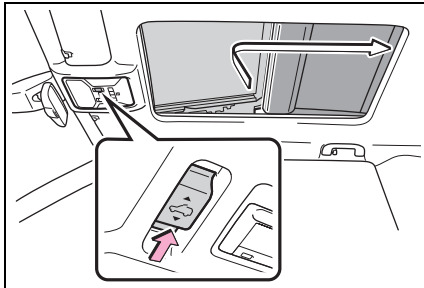

Closes the panoramic moon roof

Slide and hold the  switch forward. The panoramic moon roof will fully close automatically.

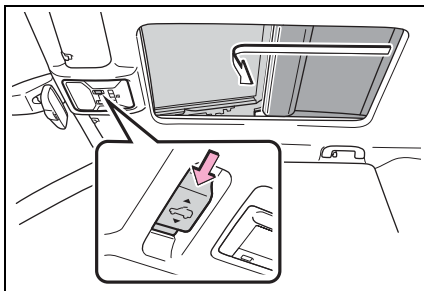

**■ The panoramic moon roof can be operated when**

The engine switch is in ON.

**■ Operating the panoramic moon roof after turning the engine off**

The panoramic moon roof and electronic sunshade can be operated for

approximately 45 seconds after the engine switch is turned to ACC or OFF. They cannot, however, be operated once either front door is opened.

**■ Jam protection function**

If an object is detected between the panoramic moon roof and the frame in the following situations, travel is stopped and the panoramic moon roof opens slightly.

- The panoramic moon roof is closing or tilting down.
- The electronic sunshade is closing.

**■ Closing both the panoramic moon roof and electronic sunshade**

Slide the  switch forward.

The electronic sunshade will close to the half-open position and pause. The panoramic moon roof will then fully close. Then the electronic sunshade will fully close.

**■ Door lock linked panoramic moon roof operation**



- The panoramic moon roof can be opened and closed using the mechanical key.\* (→P.654)
- The panoramic moon roof can be opened using the wireless remote control.\* (→P.108)
- Vehicles with alarm: The alarm may be triggered if the alarm is set and the panoramic moon roof is closed using the door lock linked panoramic moon roof operation. (→P.73)

\*: These settings must be customized at your Toyota dealer.

**■ When the panoramic moon roof or electronic sunshade does not close normally**

Perform the following procedure:

- 1 Stop the vehicle.

- 2 Turn the engine switch to ON.
- 3 Slide and hold the  switch or  switch forward. Continue sliding and holding the switch for approximately 10 seconds after the panoramic moon roof or electronic sunshade closes and reopens. The panoramic moon roof and electronic sunshade will start to close.\*
- 4 Check that the panoramic moon roof and electronic sunshade are fully closed and release the switch.

\*: If the switch is released at the incorrect time, the procedure will have to be performed again from the beginning.

If the panoramic moon roof or electronic sunshade does not fully close even after performing the above procedure correctly, have the vehicle inspected by your Toyota dealer.

**■ Panoramic moon roof open reminder function**

A buzzer sounds and a message is shown on the multi-information display when the engine switch is turned to OFF and the driver's door is opened with the panoramic moon roof open.

**■ Customization**

Settings (e.g. linked door lock operation) can be changed. (Customizable features: →P.693)

 **WARNING**  
Observe the following precautions.  
Failure to do so may result in death or serious injury.

**■ Opening and closing the electronic sunshade**

- Check to make sure that all passengers do not have any part of their body in a position where it could be caught when the electronic sunshade is being operated.

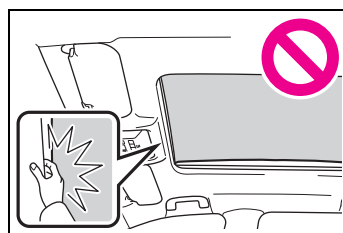

- Do not let a child operate the electronic sunshade. Closing the electronic sunshade on someone can cause death or serious injury.

**■ Opening the panoramic moon roof**

- Do not allow any passengers to put their hands or head outside the vehicle while it is moving.
- Do not sit on top of the panoramic moon roof.

**■ Opening and closing the panoramic moon roof**

- The driver is responsible for panoramic moon roof opening and closing operations. In order to prevent accidental operation, especially by a child, do not let a child operate the panoramic moon roof. It is possible for children and other passengers to have body parts caught in the panoramic moon roof.

**⚠ WARNING**

- Check to make sure that all passengers do not have any part of their body in a position where it could be caught when the panoramic moon roof is being operated.

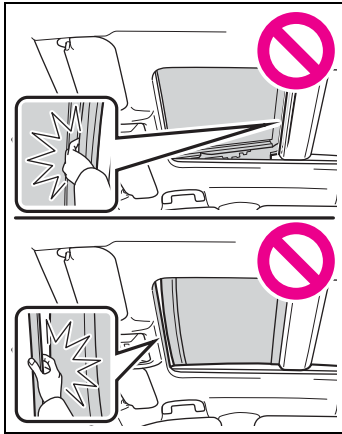

- When using the wireless remote control or mechanical key and operating the panoramic moon roof, operate the panoramic moon roof after checking to make sure that there is no possibility of any passenger having any of their body parts caught in the panoramic moon roof. Also, do not let a child operate panoramic moon roof by the wireless remote control or mechanical key. It is possible for children and other passengers to get caught in the panoramic moon roof.
- When exiting the vehicle, turn the engine switch to OFF, carry the key and exit the vehicle along with the child. There may be accidental operation, due to mischief, etc., that may possibly lead to an accident.

**■ Jam protection function**

- Never use any part of your body to intentionally activate the jam protection function.
- The jam protection function may not work if something gets caught just before the panoramic moon roof or electronic sunshade is fully closed. Also, the jam protection function is not designed to operate while the switch is being pressed. Take care so that your fingers, etc. do not get caught.

**■ To prevent burns or injuries**

Do not touch the area between the underside of the panoramic moon roof and the electronic sunshade. Your hand may get caught and you could injure yourself. Also, if the vehicle is left in direct sunlight for a long time, the underside of the panoramic moon roof could become very hot and could cause burns.

**⚠ NOTICE****■ To prevent damage to the panoramic moon roof**

- Before opening the panoramic moon roof, make sure that there are no foreign objects, such as stones or ice, around the opening.
- Do not hit the surface or edge of the panoramic moon roof with hard objects.

**■ After the vehicle has been washed or rained on**

Before opening the panoramic moon roof, wipe any water off the panoramic moon roof. Otherwise, water may enter the cabin when the panoramic moon roof is opened.



- 4-1. Before driving**
- Driving the vehicle..... 169
  - Cargo and luggage ..... 175
  - Vehicle load limits ..... 178
  - Trailer towing..... 179
  - Dinghy towing ..... 191
- 4-2. Driving procedures**
- Engine (ignition) switch  
(vehicles without smart key  
system)..... 193
  - Engine (ignition) switch  
(vehicles with smart key  
system)..... 194
  - Automatic transmission 199
  - Turn signal lever..... 202
  - Parking brake..... 203
  - Brake Hold ..... 206
- 4-3. Operating the lights and wipers**
- Headlight switch..... 209
  - AHB (Automatic High  
Beam)..... 212
  - Fog light switch ..... 215
  - Windshield wipers and  
washer..... 215
  - Rear window wiper and  
washer..... 218
- 4-4. Refueling**
- Opening the fuel tank cap  
..... 220
- 4-5. Using the driving support systems**
- Toyota Safety Sense 2.0  
..... 223
  - PCS (Pre-Collision System)  
..... 229
  - LTA (Lane Tracing Assist)  
..... 237
  - RSA (Road Sign Assist)  
..... 247
  - Dynamic radar cruise control with full-speed range  
..... 250
  - BSM (Blind Spot Monitor)  
..... 260
  - Intuitive parking assist. 270
  - PKSB (Parking Support Brake)..... 277
  - Parking Support Brake function (static objects) .... 282
  - Parking Support Brake function (rear-crossing vehicles)..... 288
  - Rear view monitor system  
..... 292
  - Toyota parking assist monitor ..... 300
  - Panoramic view monitor  
..... 313
  - Stop & Start system .... 345
  - Driving mode select switch  
..... 351

---

Multi-terrain Select (AWD vehicles).....	353
Snow mode switch (AWD vehicles).....	357
Downhill assist control system .....	358
Driving assist systems	360
<b>4-6. Driving tips</b>	
Winter driving tips .....	367
Utility vehicle precautions .....	370



## Driving the vehicle

The following procedures should be observed to ensure safe driving:

### Driving procedure

#### ■ Starting the engine

→P.193, 194

#### ■ Driving

- 1 With the brake pedal depressed, shift the shift lever to D. (→P.199)
- 2 Release the parking brake. (→P.203)

If the parking brake is in automatic mode, the parking brake is released automatically when shifting the shift lever to any position other than P. (→P.204)

- 3 Gradually release the brake pedal and gently depress the accelerator pedal to accelerate the vehicle.

#### ■ Stopping

- 1 With the shift lever in D, depress the brake pedal.
- 2 If necessary, set the parking brake. (→P.203)

If the vehicle is to be stopped for an extended period of time, shift the shift lever to P. (→P.199)

#### ■ Parking the vehicle

- 1 With the shift lever in D, depress the brake pedal.

- 2 Set the parking brake (→P.203), and shift the shift lever to P (→P.199).
- 3 Turn the engine switch to OFF to stop the engine.
- 4 Lock the door, making sure that you have the key on your person.

If parking on a hill, block the wheels as needed.

#### ■ Starting off on a steep uphill

- 1 With the brake pedal depressed, shift the shift lever to D. (→P.199)
- 2 Pull the parking brake switch and parking brake is set manually. (→P.203)
- 3 Release the brake pedal and gently depress the accelerator pedal to accelerate the vehicle.

Parking brake automatic release function (→P.205)

#### ■ When starting off on a uphill

The hill-start assist control will activate. (→P.360)

#### ■ Driving in the rain

- Drive carefully when it is raining, because visibility will be reduced, the windows may become fogged-up, and the road could be slippery.
- Drive carefully when it starts to rain, as the road surface could be especially slippery.
- Refrain from high speeds when driving on an expressway in the rain, because there may be a layer of water between the tires and the road surface, preventing

the steering and brakes from operating properly.

#### ■ Engine speed while driving

In the following conditions, the engine speed may become high while driving. This is due to automatic up-shifting control or down-shifting implementation to meet driving conditions. It does not indicate sudden acceleration.

- The vehicle is judged to be driving uphill or downhill
- When the accelerator pedal is released
- When the brake pedal is depressed while sport mode is selected

#### ■ Restraining the engine output (Brake Override System)

- When the accelerator and brake pedals are depressed at the same time, the engine output may be restrained.
- A warning message is displayed on the multi-information display while the system is operating. (→P.633)

#### ■ Restraining sudden start (Drive-Start Control)

- When the following unusual operation is performed, the engine output may be restrained.
  - When the shift lever is shifted from R to D, D to R, N to R, P to D, or P to R (D includes S) with the accelerator pedal depressed, a warning message appears on the multi-information display. If a warning message is shown on the multi-information display, read the message and follow the instructions.
  - When the accelerator pedal is depressed too much while the vehicle is in reverse.
- While Drive-Start Control is being activated, your vehicle may have trouble escaping from the mud or fresh snow. In such case, deactivate TRAC (→P.361) to cancel

Drive-Start Control so that the vehicle may be able to escape from the mud or fresh snow.

- Drive-Start Control does not work when Mud & Sand or Rock & Dirt mode is selected for Multi-terrain Select.

#### ■ Breaking in your new Toyota

To extend the life of the vehicle, observing the following precautions is recommended:

- For the first 200 miles (300 km): Avoid sudden stops.
- For the first 500 miles (800 km): Do not tow a trailer.
- For the first 600 miles (1000 km):
  - Do not drive at extremely high speeds.
  - Avoid sudden acceleration.
  - Do not drive continuously in low gears.
  - Do not drive at a constant speed for extended periods.

#### ■ Operating your vehicle in a foreign country

Comply with the relevant vehicle registration laws and confirm the availability of the correct fuel. (→P.666)



#### WARNING

Observe the following precautions. Failure to do so may result in death or serious injury.

#### ■ When starting the vehicle

Always keep your foot on the brake pedal while stopped with the engine running. This prevents the vehicle from creeping.

**WARNING****■ When driving the vehicle**

- Do not drive if you are unfamiliar with the location of the brake and accelerator pedals to avoid depressing the wrong pedal.
- Accidentally depressing the accelerator pedal instead of the brake pedal will result in sudden acceleration that may lead to an accident.
- When backing up, you may twist your body around, leading to a difficulty in operating the pedals. Make sure to operate the pedals properly.
- Make sure to keep a correct driving posture even when moving the vehicle only slightly. This allows you to depress the brake and accelerator pedals properly.
- Depress the brake pedal using your right foot. Depressing the brake pedal using your left foot may delay response in an emergency, resulting in an accident.
- Do not drive the vehicle over or stop the vehicle near flammable materials such as leaves, paper or rags. The exhaust system and exhaust gases can be extremely hot. These hot parts may cause a fire if there is any flammable material nearby.
- During normal driving, do not turn off the engine. Turning the engine off while driving will not cause loss of steering or braking control, but the power assist to these systems will be lost. This will make it more difficult to steer and brake, so you should pull over and stop the vehicle as soon as it is safe to do so. However, in the event of an emergency, such as if it becomes impossible to stop the vehicle in the normal way: →P.618
- Use engine braking (downshift) to maintain a safe speed when driving down a steep hill. Using the brakes continuously may cause the brakes to overheat and lose effectiveness. (→P.659)
- Do not adjust the position of the steering wheel, the seat, or the inside or outside rear view mirrors while driving. Doing so may result in a loss of vehicle control.
- Always check that all passengers' arms, head or other parts of their body are not outside the vehicle.
- Do not drive in excess of the speed limit. Even if the legal speed limit permits it, do not drive over 85 mph (140 km/h) unless your vehicle has high-speed capability tires. Driving over 85 mph (140 km/h) may result in tire failure, loss of control and possible injury. Be sure to consult a tire dealer to determine whether the tires on your vehicle are high-speed capability tires or not before driving at such speeds.

**⚠ WARNING****■ When driving on slippery road surfaces**

- Sudden braking, acceleration and steering may cause tire slippage and reduce your ability to control the vehicle.
- Sudden acceleration, engine braking due to shifting, or changes in engine speed could cause the vehicle to skid.
- After driving through a puddle, lightly depress the brake pedal to make sure that the brakes are functioning properly. Wet brake pads may prevent the brakes from functioning properly. If the brakes on only one side are wet and not functioning properly, steering control may be affected.

**■ When shifting the shift lever**

- Do not let the vehicle roll backward while the shift lever is in a driving position, or roll forward while the shift lever is in R. Doing so may cause the engine to stall or lead to poor brake and steering performance, resulting in an accident or damage to the vehicle.
- Do not shift the shift lever to P while the vehicle is moving. Doing so can damage the transmission and may result in a loss of vehicle control.
- Do not shift the shift lever to R while the vehicle is moving forward. Doing so can damage the transmission and may result in a loss of vehicle control.

- Do not shift the shift lever to a driving position while the vehicle is moving backward. Doing so can damage the transmission and may result in a loss of vehicle control.
- Moving the shift lever to N while the vehicle is moving will disengage the engine from the transmission. Engine braking is not available when N is selected.
- Be careful not to shift the shift lever with the accelerator pedal depressed. Shifting the shift lever to a gear other than P or N may lead to unexpected rapid acceleration of the vehicle that may cause an accident and result in death or serious injury. Doing so can damage the transmission and may result in a loss of vehicle control.

**■ If you hear a squealing or scraping noise (brake pad wear limit indicators)**

Have the brake pads checked and replaced by your Toyota dealer as soon as possible.

Rotor damage may result if the pads are not replaced when needed.

It is dangerous to drive the vehicle when the wear limits of the brake pads and/or those of the brake discs are exceeded.

**■ When the vehicle is stopped**

- Do not race the engine. If the vehicle is in any gear other than P or N, the vehicle may accelerate suddenly and unexpectedly, causing an accident.
- In order to prevent accidents due to the vehicle rolling away, always keep depressing the brake pedal while the engine is running, and apply the parking brake as necessary.

**WARNING**

- If the vehicle is stopped on an incline, in order to prevent accidents caused by the vehicle rolling forward or backward, always depress the brake pedal and securely apply the parking brake as needed.

- Avoid revving or racing the engine.  
Running the engine at high speed while the vehicle is stopped may cause the exhaust system to overheat, which could result in a fire if combustible material is nearby.

**■ When the vehicle is parked**

- Do not leave glasses, cigarette lighters, spray cans, or soft drink cans in the vehicle when it is in the sun.  
Doing so may result in the following:

- Gas may leak from a cigarette lighter or spray can, and may lead to a fire.
- The temperature inside the vehicle may cause the plastic lenses and plastic material of glasses to deform or crack.
- Soft drink cans may fracture, causing the contents to spray over the interior of the vehicle, and may also cause a short circuit in the vehicle's electrical components.

- Do not leave cigarette lighters in the vehicle. If a cigarette lighter is in a place such as the glove box or on the floor, it may be lit accidentally when luggage is loaded or the seat is adjusted, causing a fire.

- Do not attach adhesive discs to the windshield or windows. Do not place containers such as air fresheners on the instrument panel or dashboard. Adhesive discs or containers may act as lenses, causing a fire in the vehicle.

- Do not leave a door or window open if the curved glass is coated with a metallized film such as a silver-colored one. Reflected sunlight may cause the glass to act as a lens, causing a fire.

- Always apply the parking brake, shift the shift lever to P, stop the engine and lock the vehicle. Do not leave the vehicle unattended while the engine is running.  
If the vehicle is parked with the shift lever in P but the parking brake is not set, the vehicle may start to move, possibly leading to an accident.

- Do not touch the exhaust pipes while the engine is running or immediately after turning the engine off.  
Doing so may cause burns.

**■ When taking a nap in the vehicle**

Always turn the engine off. Otherwise, if you accidentally move the shift lever or depress the accelerator pedal, this could cause an accident or fire due to engine overheating. Additionally, if the vehicle is parked in a poorly ventilated area, exhaust gases may collect and enter the vehicle, leading to death or a serious health hazard.

**WARNING****■ When braking**

- When the brakes are wet, drive more cautiously. Braking distance increases when the brakes are wet, and this may cause one side of the vehicle to brake differently than the other side. Also, the parking brake may not securely hold the vehicle.
- If the brake booster device does not operate, do not follow other vehicles closely and avoid hills or sharp turns that require braking. In this case, braking is still possible, but the brake pedal should be depressed more firmly than usual. Also, the braking distance will increase. Have your brakes fixed immediately.
- Do not pump the brake pedal if the engine stalls. Each push on the brake pedal uses up the reserve for the power-assisted brakes.
- The brake system consists of 2 individual hydraulic systems; if one of the systems fails, the other will still operate. In this case, the brake pedal should be depressed more firmly than usual and the braking distance will increase. Have your brakes fixed immediately.

**■ If the vehicle becomes stuck (AWD models)**

Do not spin the wheels excessively when any of the tires is up in the air, or the vehicle is stuck in sand, mud, etc. This may damage the driveline components or propel the vehicle forward or backward, causing an accident.

**NOTICE****■ When driving the vehicle**

- Do not depress the accelerator and brake pedals at the same time during driving, as this may restrain the engine output.
- Do not use the accelerator pedal or depress the accelerator and brake pedals at the same time to hold the vehicle on a hill.

**■ Avoiding damage to vehicle parts**

- Do not turn the steering wheel fully in either direction and hold it there for an extended period of time. Doing so may damage the power steering motor.
- When driving over bumps in the road, drive as slowly as possible to avoid damaging the wheels, underside of the vehicle, etc.

**■ If you get a flat tire while driving**

A flat or damaged tire may cause the following situations.

- It may be difficult to control your vehicle.
- The vehicle will make abnormal sounds or vibrations.
- The vehicle will lean abnormally.

Hold the steering wheel firmly and gradually depress the brake pedal to slow down the vehicle.

Information on what to do in case of a flat tire (→P.642)

**NOTICE****■ When encountering flooded roads**

Do not drive on a road that has flooded after heavy rain, etc. Doing so may cause the following serious damage to the vehicle:

- Engine stalling
- Short in electrical components
- Engine damage caused by water immersion

In the event that you drive on a flooded road and the vehicle is flooded, be sure to have your Toyota dealer check the following:

- Brake function
- Changes in quantity and quality of oil and fluid used for the engine, transaxle, transfer (AWD vehicles), rear differential (AWD vehicles), etc.
- Lubricant condition for the propeller shaft (AWD models), bearings and suspension joints (where possible), and the function of all joints, bearings, etc.

**■ When parking the vehicle**

Always set the parking brake, and shift the shift lever to P. Failure to do so may cause the vehicle to move or the vehicle may accelerate suddenly if the accelerator pedal is accidentally depressed.

**Cargo and luggage**

**Take notice of the following information about storage precautions, cargo capacity and load.**

**WARNING****■ Things that must not be carried in the luggage compartment**

The following things may cause a fire if loaded in the luggage compartment:

- Receptacles containing gasoline
- Aerosol cans

**■ Storage precautions**

Observe the following precautions.

Failure to do so may prevent the pedals from being depressed properly, may block the driver's vision, or may result in items hitting the driver or passengers, possibly causing an accident.

- Stow cargo and luggage in the luggage compartment whenever possible.
- Do not stack anything in the luggage compartment higher than the seatbacks.
- Do not place cargo or luggage in or on the following locations.
  - At the feet of the driver
  - On the front passenger or rear seats (when stacking items)
  - On the luggage cover (if equipped)
  - On the instrument panel
  - On the dashboard

**⚠ WARNING**

- Secure all items in the occupant compartment.
- When you fold down the rear seats, long items should not be placed directly behind the front seats.
- Never allow anyone to ride in the luggage compartment. It is not designed for passengers. They should ride in their seats with their seat belts properly fastened. Otherwise, they are much more likely to suffer death or serious bodily injury, in the event of sudden braking, sudden swerving or an accident.

**Capacity and distribution**

Cargo capacity depends on the total weight of the occupants.

(Cargo capacity) = (Total load capacity) - (Total weight of occupants)

**Steps for Determining Correct Load Limit —**

- (1) Locate the statement “The combined weight of occupants and cargo should never exceed XXX kg or XXX lbs.” on your vehicle’s placard.
- (2) Determine the combined weight of the driver and passengers that will be riding in your vehicle.
- (3) Subtract the combined weight of the driver and passengers from XXX kg or XXX lbs.
- (4) The resulting figure equals

the available amount of cargo and luggage load capacity.

For example, if the “XXX” amount equals 1400 lbs. and there will be five 150 lb passengers in your vehicle, the amount of available cargo and luggage load capacity is 650 lbs. (1400 - 750 (5 × 150) = 650 lbs.)

(5) Determine the combined weight of luggage and cargo being loaded on the vehicle. That weight may not safely exceed the available cargo and luggage load capacity calculated in Step 4.

(6) If your vehicle will be towing a trailer, load from your trailer will be transferred to your vehicle. Consult this manual to determine how this reduces the available cargo and luggage load capacity of your vehicle. (→P.178)

**⚠ WARNING****Capacity and distribution**

- Do not exceed the maximum axle weight rating or the total vehicle weight rating.
- Even if the total load of occupant weight and the cargo load is less than the total load capacity, do not apply the load unevenly. Improper loading may cause deterioration of steering or braking control which may cause death or serious injury.



**Calculation formula for your vehicle**

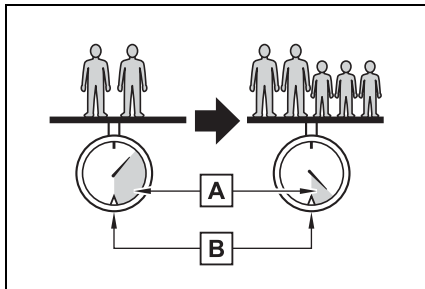

- A** Cargo capacity
- B** Total load capacity (vehicle capacity weight) (→P.664)

When 2 people with the combined weight of A lb. (kg) are riding in your vehicle, which has a total load capacity (vehicle capacity weight) of B lb. (kg), the available amount of cargo and luggage load capacity will be C lb. (kg) as follows:

$$B^{*2} \text{ lb. (kg)} - A^{*1} \text{ lb. (kg)} = C^{*3} \text{ lb. (kg)}$$

- \*1: A = Weight of people
- \*2: B = Total load capacity
- \*3: C = Available cargo and luggage load

In this condition, if 3 more passengers with the combined weight of D lb. (kg) get on, the available cargo and luggage load will be reduced E lb. (kg) as follows:

$$C \text{ lb. (kg)} - D^{*4} \text{ lb. (kg)} = E^{*5} \text{ lb. (kg)}$$

- \*4: D = Additional weight of people
- \*5: E = Available cargo and luggage

load

As shown in the example above, if the number of occupants increases, the cargo and luggage load will be reduced by an amount that equals the increased weight due to the additional occupants. In other words, if an increase in the number of occupants causes an excess of the total load capacity (combined weight of occupants plus cargo and luggage load), you must reduce the cargo and luggage on your vehicle.

**⚠ WARNING**

**When loading cargo on the roof luggage carrier (if equipped)**

Observe the following precautions:

- Place the cargo so that its weight is distributed evenly between the front and rear axles.
- If loading long or wide cargo, never exceed the vehicle overall length or width. (→P.664)
- Before driving, make sure the cargo is securely fastened on the roof luggage carrier.
- Loading cargo on the roof luggage carrier will make the center of gravity of the vehicle higher. Avoid high speeds, sudden starts, sharp turns, sudden braking or abrupt maneuvers, otherwise it may result in loss of control or vehicle rollover due to failure to operate this vehicle correctly and result in death or serious injury.

**⚠ WARNING**

- If driving for a long distance, on rough roads, or at high speeds, stop the vehicle now and then during the trip to make sure the cargo remains in its place.
- Do not exceed 176.4 lb. (80 kg) cargo weight on the roof luggage carrier.

**⚠ NOTICE****■ When loading cargo on the roof luggage carrier (if equipped)**

Be careful not to scratch the surface of the moon roof (if equipped) or the panoramic moon roof (if equipped).

**Vehicle load limits****Vehicle load limits include total load capacity, seating capacity, TWR (Trailer Weight Rating) and cargo capacity.**

- Total load capacity (vehicle capacity weight): →P.664

Total load capacity means the combined weight of occupants, cargo and luggage.

- Seating capacity: 5 occupants (Front 2, Rear 3)

Seating capacity means the maximum number of occupants whose estimated average weight is 150 lb. (68 kg) per person.

- TWR (Trailer Weight Rating): →P.185, 664

TWR means the maximum gross trailer weight (trailer weight plus its cargo weight) that your vehicle is able to tow.

- Cargo capacity

Cargo capacity may increase or decrease depending on the weight and the number of occupants.

**■ Total load capacity and seating capacity**

These details are also described on the tire and loading information label. (→P.595)

**WARNING****■ Overloading the vehicle**

Do not overload the vehicle. It may not only cause damage to the tires, but also degrade steering and braking ability, resulting in an accident.

**Trailer towing**

**Your vehicle is designed primarily as a passenger-and-load-carrying vehicle. Towing a trailer can have an adverse impact on handling, performance, braking, durability, and fuel consumption. For your safety and the safety of others, you must not overload your vehicle or trailer. You must also ensure that you are using appropriate towing equipment, that the towing equipment has been installed correctly and used properly, and that you employ the requisite driving habits.**

**Vehicle-trailer stability and braking performance are affected by trailer stability, brake performance and setting, trailer brakes, the hitch and hitch systems (if equipped).**

**To tow a trailer safely, use extreme care and drive the vehicle in accordance with your trailer's characteristics and operating conditions.**

**Toyota warranties do not apply to damage or malfunction caused by towing a trailer for commercial purposes.**

Contact your Toyota dealer for further information about additional requirements such as a towing kit, etc.

**■ Before towing**

Check that the following conditions are met:

- Ensure that your vehicle's tires are properly inflated. (→P.671)
- Trailer tires are inflated according to the trailer manufacturer's recommendation.
- All trailer lights work as required by law.
- All lights work each time you connect them.
- The trailer ball is set at the proper height for the coupler on the trailer.
- The trailer is level when it is hitched.  
Do not drive if the trailer is not level, and check for improper tongue weight, overloading, worn suspension, or other possible causes.
- The trailer cargo is securely loaded.
- The rear view mirrors conform to all applicable federal, state/provincial or local regulations. If they do not, install rear view mirrors appropriate for towing purposes.

**⚠ WARNING**

**■ Trailer towing precautions**

To tow a trailer safely, use extreme care and drive the vehicle in accordance with the trailer's characteristics and operating conditions. Failure to do so could cause an accident resulting in death or serious injury. Vehicle stability and braking performance are affected by trailer stability, brake setting and performance, and the hitch. Your vehicle will handle differently when towing a trailer.

**■ To avoid accident or injury**

- Do not exceed the TWR, unbraked TWR, GCWR, GVWR or GAWR.
- Vehicles with towing package: If the gross trailer weight is over 2000 lb. (907 kg), a sway control device with sufficient capacity is required.
- Adjust the tongue weight within the appropriate range. Place heavier loads as close to the trailer axle as possible.
- Do not exceed 65 mph (104 km/h), the posted towing speed limit or the speed limit for your trailer as set forth in your trailer owner's manual, whichever is lowest. Slow down sufficiently before making a turn, in cross winds, on wet or slippery surface, etc. to help avoid an accident. If you experience a vehicle-trailer instability from reducing a certain speed, slow down and make sure you keep your vehicle speed under the speed of which you experience the instability.
- Do not make jerky, abrupt or sharp turns.

**⚠ WARNING**

- Do not apply the brakes suddenly as you may skid, resulting in jackknifing and loss of vehicle control. This is especially true on wet or slippery surfaces.
- Do not exceed the trailer hitch assembly weight, gross vehicle weight, gross axle weight and trailer tongue weight capacities.
- Do not use dynamic radar cruise control with full-speed range when towing.
- Slow down and downshift before descending steep or long downhill grades. Do not make sudden downshifts while descending steep or long downhill grades.
- Vehicle-trailer instability is more likely on steep long downhills. Before descending steep or long downhill grades, slow down and downshift. Do not make sudden downshifts when descending steep or long downhill grades. Avoid holding the brake pedal down too long or applying the brakes too frequently. This could cause the brakes to overheat and result in reduced braking efficiency.
- Do not tow a trailer when the compact spare tire is installed on your vehicle.

**■ When towing a trailer**

Toyota recommends trailers with brakes that conform to any applicable federal and state/provincial regulations.

- If the gross trailer weight exceeds unbraked TWR, trailer brakes are required. Toyota recommends trailers with brakes that conform to all applicable federal and state/provincial regulations.
- Never tap into your vehicle's hydraulic system, as this will lower the vehicle's braking effectiveness.
- Never tow a trailer without using a safety chain securely attached to both the trailer and the vehicle. If damage occurs to the coupling unit or hitch ball, there is danger of the trailer wandering into another lane.

**Towing related terms****■ GCWR (Gross Combination Weight Rating)**

The maximum allowable gross combination weight. The gross combination weight is the sum of the total vehicle weight (including the occupants, cargo and any optional equipment installed on the vehicle) and the weight of the trailer being towed (including the cargo in the trailer).

- ▶ Vehicles without towing package

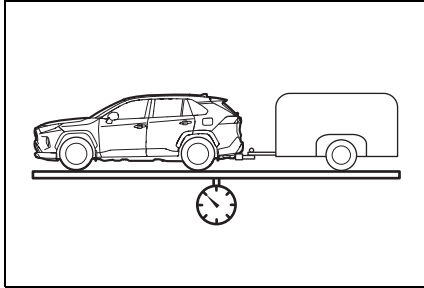

- ▶ Vehicles without towing package

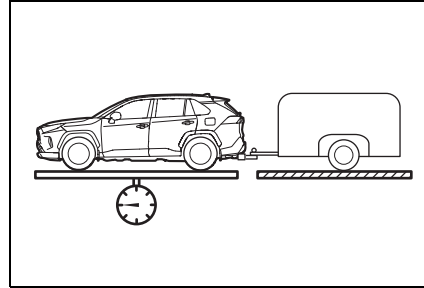

- ▶ Vehicles with towing package

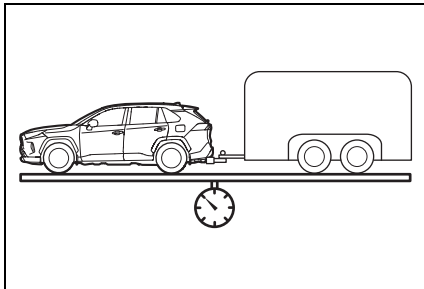

- ▶ Vehicles with towing package

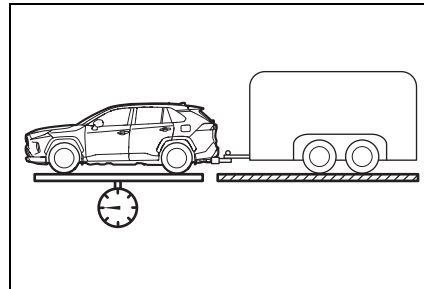

■ **GVWR (Gross Vehicle Weight Rating)**

The maximum allowable gross vehicle weight. The gross vehicle weight is the total weight of the vehicle. When towing a trailer, it is the sum of the vehicle weight (including the occupants, cargo and any optional equipment installed on the vehicle) and the tongue weight.

■ **GAWR (Gross Axle Weight Rating)**

The maximum allowable gross axle weight. The gross axle weight is the load placed on each axle (front and rear).

- ▶ Vehicles without towing package

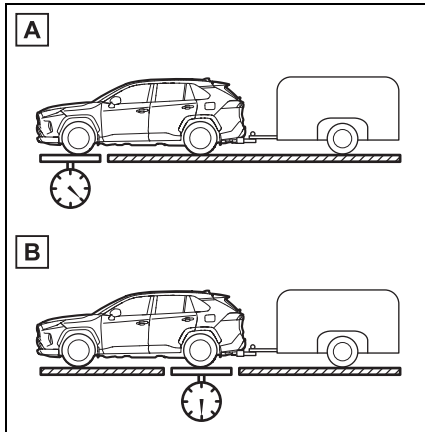

- A** Front GAWR
- B** Rear GAWR

- ▶ Vehicles with towing package

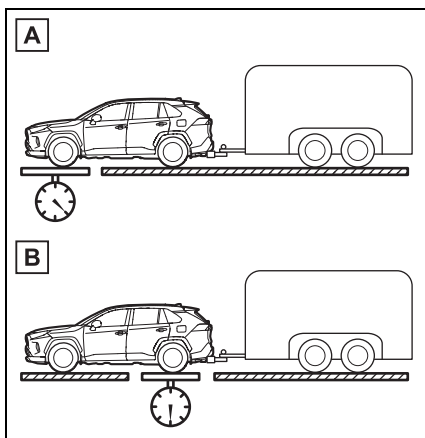

- A** Front GAWR
- B** Rear GAWR

■ **TWR (Trailer Weight Rating)**

The maximum allowable gross trailer weight. The gross trailer weight is the sum of the trailer weight and the weight of the

cargo in the trailer.

TWR is calculated assuming base vehicle with one driver, one front passenger, towing package (if available), hitch and hitch systems (if required).

Additional optional equipment, passengers and cargo in the vehicle will reduce the trailer weight rating so as not to exceed GCWR, GVWR and GAWR.

Vehicles with towing package: If the gross trailer weight exceeds 3000 lb. (1360 kg), it is recommended to use a trailer with 2 or more axles.

- ▶ Vehicles without towing package

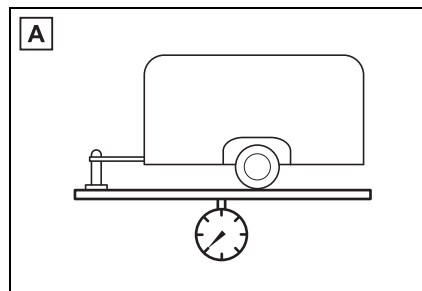

- A** (With brakes)

- ▶ Vehicles with towing package

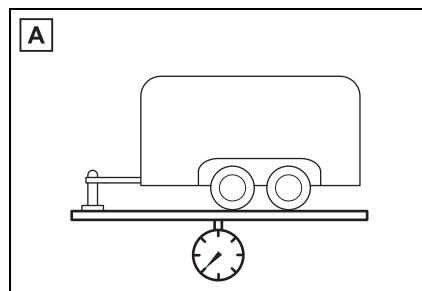

- A** (With brakes)

■ **Unbraked TWR (Unbraked Trailer Weight Rating)**

The trailer weight rating for towing a trailer without a trailer service brake system.

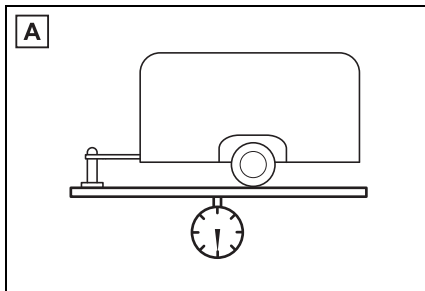

A (Without brakes)

■ **Tongue Weight**

The load placed on the trailer hitch ball. (→P.186)

- ▶ Vehicles without towing package

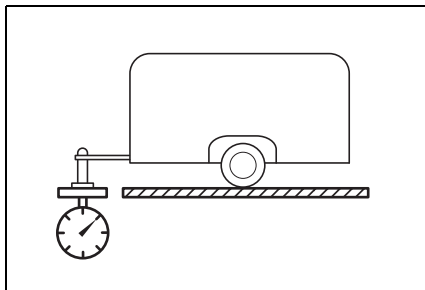

- ▶ Vehicles with towing package

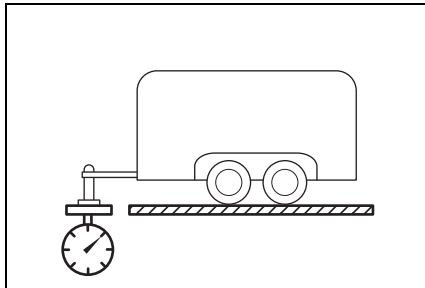

**Weight limits**

- The gross trailer weight must never exceed the TWR described below.

- ▶ Without towing package  
1500 lb. (680 kg)

- ▶ With towing package  
3500 lb. (1590 kg)

- The gross combination weight must never exceed the GCWR described below.

- ▶ Without towing package

Vehicles without Dynamic Torque Vectoring AWD system: 6110 lb. (2770 kg)

Vehicles with Dynamic Torque Vectoring AWD system: 6205 lb. (2815 kg)

- ▶ With towing package  
8205 lb. (3725 kg)

- The gross vehicle weight must never exceed the GVWR indicated on the Certification Regulation Label.

- The gross axle weight on each axle must never exceed the GAWR indicated on the Certification Regulation Label.

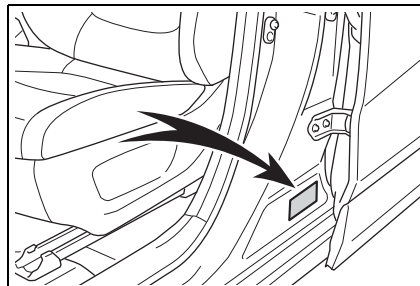



- If the gross trailer weight is over the unbraked TWR, trailer service brakes are required.
- Vehicles with towing package: If the gross trailer weight is over 2000 lb. (907 kg), a sway control device with sufficient capacity is required.

**GCWR, TWR and Unbraked TWR**

Confirm that the gross trailer weight, gross combination weight, gross vehicle weight, gross axle weight and tongue weight are all within the limits.

■ **GCWR\***

- ▶ Without towing package

Vehicles without Dynamic Torque Vectoring AWD system: 6110 lb. (2770 kg)

Vehicles with Dynamic Torque Vectoring AWD system: 6205 lb. (2815 kg)

- ▶ With towing package

8205 lb. (3725 kg)

\*: These models meet the tow-vehicle trailering requirement of SAE International per SAE J2807.

■ **TWR\***

- ▶ Without towing package

1500 lb. (680 kg)

- ▶ With towing package

3500 lb. (1590 kg)

\*: These models meet the tow-vehicle trailering requirement of SAE International per SAE J2807.

■ **Unbraked TWR\***

1000 lb. (450 kg)

\*: These models meet the tow-vehicle trailering requirement of SAE International per SAE J2807.

**Trailer Tongue Weight**

- A recommended tongue weight varies in accordance with the types of trailers or towing as described below.
- To ensure the recommended values shown below, the trailer must be loaded by referring to the following instructions.

- Tongue Weight

The gross trailer weight should be distributed so that the tongue weight is 9% to 11%.

(Tongue weight /Gross trailer weight x 100 = 9% to 11%)

- ▶ Vehicles without towing package

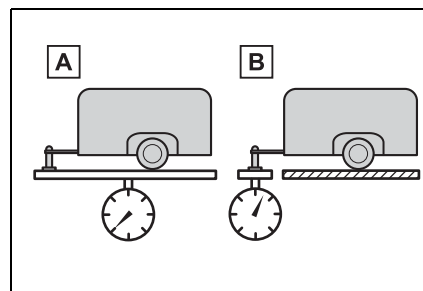

**A** Gross trailer weight

**B** Tongue weight

► Vehicles with towing package

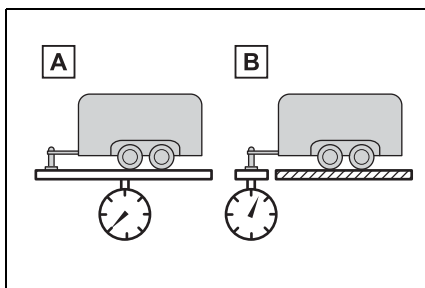

**A** Gross trailer weight

**B** Tongue weight

The gross trailer weight, gross axle weight and tongue weight can be measured with platform scales found at a highway weighing station, building supply company, trucking company, junk yard, etc.

**Hitch**

Trailer hitch assemblies have different weight capacities. Toyota recommends the use of Toyota hitch/bracket for your vehicle. For details, contact your Toyota dealer.

- If you wish to install a trailer hitch, contact your Toyota dealer.
- Use only a hitch that conforms to the gross trailer weight requirement of your vehicle.
- Follow the directions supplied by the hitch manufacturer.

- Lubricate the hitch ball with a light coating of grease.
- Remove the hitch ball whenever you are not towing a trailer. Remove the trailer hitch if you do not need it. After removing the hitch, seal any mounting holes in the vehicle body to prevent entry of any substances into the vehicle.

**WARNING**

**Hitch**

Trailer hitch assemblies have different weight capacities established by the hitch manufacturer. Even though the vehicle may be physically capable of towing a higher weight, the operator must determine the maximum weight rating of the particular hitch assembly and never exceed the maximum weight rating specified for the trailer-hitch. Exceeding the maximum weight rating set by the trailer-hitch manufacturer can cause an accident resulting in death or serious personal injuries.

**NOTICE**

**When installing a trailer hitch**

Use only the position recommended by your Toyota dealer. Do not install the trailer hitch on the bumper; this may cause body damage.

**Selecting trailer ball (vehicles with towing package)**

Use the correct trailer ball for your application.

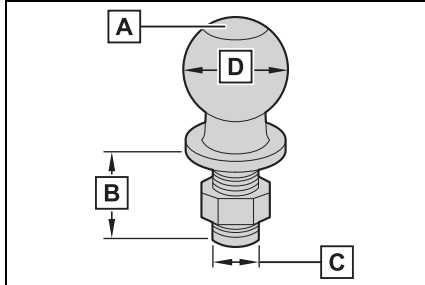

- A** Trailer ball load rating  
Matches or exceeds the gross trailer weight rating of the trailer.
- B** Shank length  
Protrudes beyond the bottom of the lock washer and nut by at least 2 threads.
- C** Shank diameter  
Matches the ball mount hole diameter size.
- D** Ball diameter  
Matches the size of the trailer coupler. Most couplers are stamped with the required trailer ball size.

Trailer class	Typical trailer ball size
IV	2 5/16 in.
II and III	2 in.
I	1 7/8 in.

**Positions for towing hitch receiver and hitch ball**

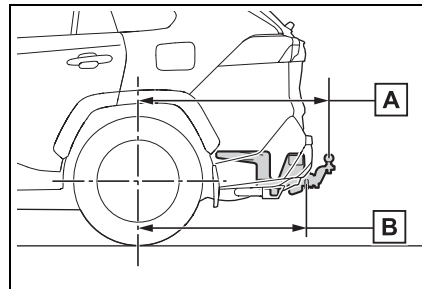

- A** Weight carrying ball position:  
43.3 in. (1100 mm)
- B** Hitch receiver pin hole position:  
38.1 in. (969 mm)

**Matching trailer ball height to trailer coupler height**

No matter which class of tow hitch applies, for a more safe trailer hookup, the trailer ball setup must be the proper height for the coupler on the trailer.

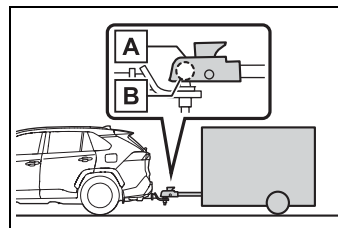
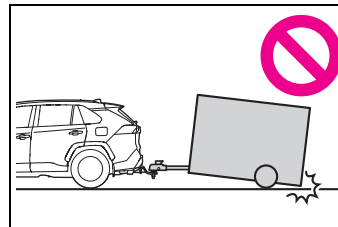

- A** Coupler
- B** Trailer ball

### Connecting trailer lights

Please consult your dealer when installing trailer lights, as incorrect installation may cause damage to the vehicle's lights. Please take care to comply with your state's laws when installing trailer lights.



#### NOTICE

#### ■ Do not directly splice trailer lights

Do not directly splice trailer lights. Directly splicing trailer lights may damage your vehicle's electrical system and cause a malfunction.

### Trailer towing tips

Your vehicle will handle differently when towing a trailer. Help to avoid an accident, death or serious injury, keep the following in mind when towing:

- Speed limits for towing a trailer vary by state or province. Do not exceed the posted towing speed limit.
- Toyota recommends that the vehicle-trailer speed limit is 65 mph (104 km/h) on a flat, straight, dry road. Do not exceed this limit, the posted towing speed limit or the speed limit for your trailer as set forth in your trailer owner's manual, whichever is lowest. Instability of the towing vehicle-trailer combination (trailer sway) increases as speed increases. Exceeding speed limits may cause loss of control.
- Before starting out, check the trailer lights, tires and the vehicle-trailer connections. Recheck after driving a short distance.
- Practice turning, stopping and reversing with the trailer attached in an area away from traffic until you become accustomed to the feel of the vehicle-trailer combination.
- Reversing with a trailer attached is difficult and requires practice. Grip the bottom of the steering wheel and move your hand to the left to move the trailer to the left. Move your hand to the right to move the trailer to right. (This is generally opposite to reversing without a trailer attached.) Avoid sharp or prolonged turning. Have someone guide you when reversing to reduce the risk of an accident.
- As stopping distance is increased when towing a trailer, vehicle-to-vehicle distance should be increased. For each 10 mph (16 km/h) of speed, allow at least one vehicle and trailer length.
- Avoid sudden braking as you may skid, resulting in the trailer jackknifing and a loss of

vehicle control. This is especially true on wet or slippery surfaces.

- Avoid jerky starts or sudden acceleration.
- Avoid jerky steering and sharp turns, and slow down before making turn.
- Note that when making a turn, the trailer wheels will be closer than the vehicle wheels to the inside of the turn. Compensate by making a wider than normal turning radius.
- Slow down before making a turn, in cross winds, on wet or slippery surfaces, etc.

Increasing vehicle speed can destabilize the trailer.

- Take care when passing other vehicles. Passing requires considerable distance. After passing a vehicle, do not forget the length of your trailer, and be sure you have plenty of room before changing lanes.
- To maintain engine braking efficiency and charging system performance when using engine braking, do not put the transmission in D. If in the S mode, the transmission shift range position must be in 6 or lower.
- Instability happens more frequently when descending steep or long downhill grades.

Before descending, slow down and downshift. Do not make sudden downshifts while descending steep or long downhill grades.

- Avoid holding the brake pedal down too long or applying the brakes too frequently. This could cause the brakes to overheat and result in reduced braking efficiency.
- Due to the added load of the trailer, your vehicle's engine may overheat on hot days (at temperatures over 85°F [30°C]) when driving up a long or steep grade. If the engine coolant temperature gauge indicates overheating, immediately turn off the air conditioning (if in use), pull your vehicle off the road and stop in a safe spot. (→P.659)
- Always place wheel blocks under both the vehicle's and the trailer's wheels when parking. Apply the parking brake firmly, and put the transmission in P. Avoid parking on a slope, but if unavoidable, do so only after performing the following:
  - 1 Apply the brakes and keep them applied.
  - 2 Have someone place wheel blocks under both the vehicle's and trailer's wheels.

- 3 When the wheel blocks are in place, release the brakes slowly until the blocks absorb the load.
  - 4 Apply the parking brake firmly.
  - 5 Shift into P and turn off the engine.
- When restarting after parking on a slope:
    - 1 With the transmission in P, start the engine. Be sure to keep the brake pedal depressed.
    - 2 Shift into a forward gear. If reversing, shift into R.
    - 3 If the parking brake is in manual mode, release the parking brake. (→P.203)
    - 4 Release the brake pedal, and slowly pull or back away from the wheel blocks. Stop and apply the brakes.
    - 5 Have someone retrieve the blocks.

---

#### ■ Break-in schedule

If your vehicle is new or equipped with any new power train components (such as an engine, transmission, differential or wheel bearing), Toyota recommends that you do not tow a trailer until the vehicle has been driven for over 500 miles (800 km).

After the vehicle has been driven for over 500 miles (800 km), you can start towing. However, for the next 500 miles (800 km), drive the vehicle at a speed of less than 45 mph (72 km/h) when towing a trailer, and

avoid full throttle acceleration.

#### ■ Maintenance

- If you tow a trailer, your vehicle will require more frequent maintenance due to the additional load. (See “Scheduled Maintenance Guide” or “Owner’s Manual Supplement”.)
- Retighten the fixing bolts of the towing ball and bracket after approximately 600 miles (1000 km) of trailer towing.

#### ■ If trailer sway occurs

One or more factors (crosswinds, passing vehicles, rough roads, etc.) can adversely affect handling of your vehicle and trailer, causing instability.

- If trailer swaying occurs:
  - Firmly grip the steering wheel. Steer straight ahead. Do not try to control trailer swaying by turning the steering wheel.
  - Begin releasing the accelerator pedal immediately but very gradually to reduce speed. Do not increase speed. Do not apply vehicle brakes.

If you make no extreme correction with the steering or brakes, your vehicle and trailer should stabilize (if enabled, Trailer Sway Control can also help to stabilize the vehicle and trailer.).

- After the trailer swaying has stopped:
  - Stop in a safe place. Get all occupants out of the vehicle.
  - Check the tires of the vehicle and the trailer.
  - Check the load in the trailer. Make sure the load has not shifted. Make sure the tongue weight is appropriate, if possible.
  - Check the load in the vehicle. Make sure the vehicle is not overloaded after occupants get in.

If you cannot find any problems, the

speed at which trailer swaying occurred is beyond the limit of your particular vehicle-trailer combination. Drive at a lower speed to prevent instability. Remember that swaying of the towing vehicle-trailer increases as speed increases.

### Dinghy towing

**Your vehicle is not designed to be dinghy towed (with 4 wheels on the ground) behind a motor home.**

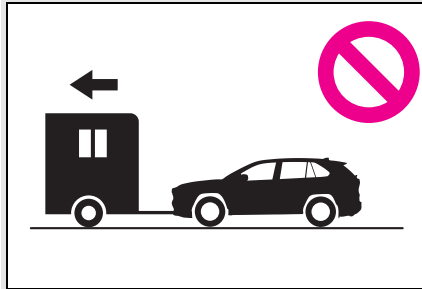

 NOTICE

■ **To avoid serious damage to your vehicle**

Do not tow your vehicle with 4 wheels on the ground.

■ **To prevent causing serious damage to the transmission and AWD system (AWD models)**

2WD models: Never tow this vehicle from the rear with the front wheels on the ground. This may cause serious damage to the transmission.

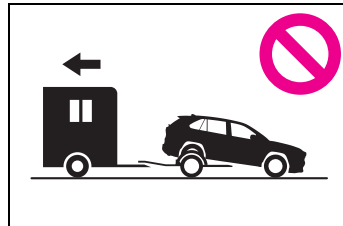

 NOTICE

AWD models: Never tow this vehicle with any of the wheels on the ground. This may cause serious damage to the transmission and AWD system.

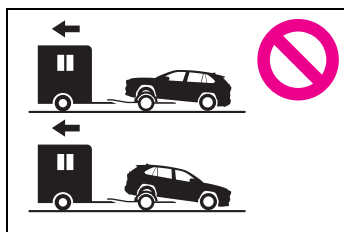



Engine (ignition) switch (vehicles without smart key system)

**Starting the engine**

- 1 Pull the parking brake switch to check that the parking brake is set. (→P.203)

The parking brake indicator will come on.

- 2 Check that the shift lever is set in P.
- 3 Firmly depress the brake pedal.
- 4 Turn the engine switch to START to start the engine.

**■ If the engine does not start**

The engine immobilizer system may not have been deactivated. (→P.70) Contact your Toyota dealer.

**■ When the steering lock cannot be released**

When starting the engine, the engine switch may seem stuck in OFF. To free it, turn the key while turning the steering wheel slightly left and right.

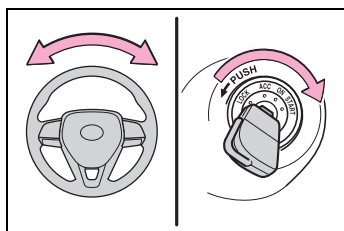

**■ When “Check Fuel Cap” is displayed on the multi-information display**

→P.221

**⚠ WARNING**

**■ When starting the engine**

Always start the engine while sitting in the driver’s seat. Do not depress the accelerator pedal while starting the engine under any circumstances.

Doing so may cause an accident resulting in death or serious injury.

**⚠ NOTICE**

**■ When starting the engine**

● Do not crank the engine for more than 30 seconds at a time. This may overheat the starter and wiring system.

● Do not race a cold engine.

● If the engine becomes difficult to start or stalls frequently, have your vehicle checked by your Toyota dealer immediately.

**Changing the engine switch positions**

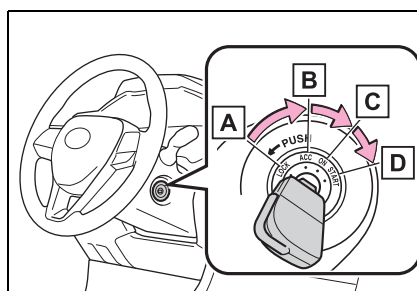

**A OFF (“LOCK” position)**

The steering wheel is locked and the key can be removed. (The key can be removed only when the shift lever is in P.)

**B ACC (“ACC” position)**

Some electrical components such

as the audio system can be used.

**C** ON (“ON” position)

All electrical components can be used.

**D** START (“START” position)

For starting the engine.

**Turning the key from ACC to OFF**

- 1 Shift the shift lever to P.
- 2 Push in the key and turn it to OFF.

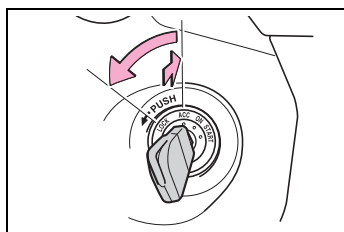

**Key reminder function**

A buzzer sounds if the driver’s door is opened while the engine switch is in OFF or ACC to remind you to remove the key.

**⚠ WARNING**

**Caution when driving**

Do not turn the engine switch to OFF while driving. If, in an emergency and you must turn the engine off while the vehicle is moving, turn the engine switch only to ACC to stop the engine. An accident may result if the engine is stopped while driving. (→P.618)

**⚠ NOTICE**

**To prevent battery discharge**

Do not leave the engine switch in ACC or ON for long periods of time without the engine running.

Engine (ignition) switch (vehicles with smart key system)

**Performing the following operations when carrying the electronic key on your person starts the engine or changes engine switch modes.**

**Starting the engine**

- 1 Pull the parking brake switch to check that the parking brake is set. (→P.203)

The parking brake indicator will come on.

- 2 Check that the shift lever is set in P.
- 3 Firmly depress the brake pedal.

 and a message will be displayed on the multi-information display.

If it is not displayed, the engine cannot be started.

- 4 Press the engine switch shortly and firmly.

When operating the engine switch, one short, firm press is enough. It is not necessary to press and hold the switch.

The engine will crank until it starts or for up to 30 seconds, whichever is less.

Continue depressing the brake pedal until the engine is completely started.

The engine can be started from any

engine switch mode.

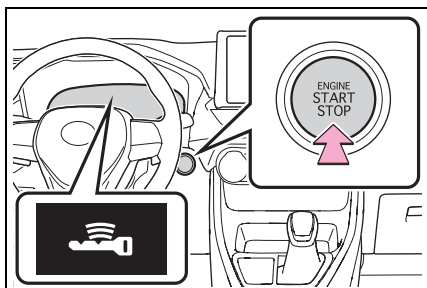

■ **If the engine does not start**

- The engine immobilizer system may not have been deactivated. (→P.70)  
Contact your Toyota dealer.
- If a message related to start-up is shown on the multi-information display, read the message and follow the instructions.

■ **If the battery is discharged**

The engine cannot be started using the smart key system. Refer to P.655 to restart the engine.

■ **Electronic key battery depletion**

→P.102

■ **Conditions affecting operation**

→P.129

■ **Note for the entry function**

→P.130

■ **Steering lock function**

- After turning the engine switch to OFF and opening and closing the doors, the steering wheel will be locked due to the steering lock function. Operating the engine switch again automatically cancels the steering lock.
- When the steering lock cannot be released, "Push Engine Switch while Turning Steering Wheel in Either Direction" will be displayed on the multi-information display. Check that the shift lever is set in P. Press the engine switch shortly and firmly while turning the steer-

ing wheel left and right.

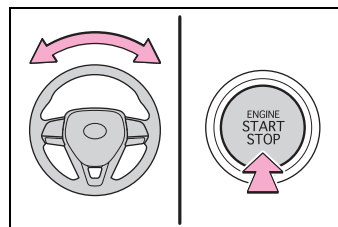

- To prevent the steering lock motor from overheating, the operation of motor may be suspended if the engine is turned on and off repeatedly in a short period of time. In this case, refrain from running the engine. After about 10 seconds, the steering lock motor will resume functioning.

■ **If there is a malfunction in the smart key system**

If "Smart Key System Malfunction" is displayed on the multi-information display, the system may be malfunctioning. Have the vehicle inspected by your Toyota dealer immediately.

■ **When "Check Fuel Cap" is displayed on the multi-information display**

→P.221

■ **Electronic key battery**

→P.604

■ **Operation of the engine switch**

- If the switch is not pressed shortly and firmly, the engine switch mode may not change or the engine may not start.
- If attempting to restart the engine immediately after turning the engine switch to OFF, the engine may not start in some cases. After turning the engine switch to OFF, please wait a few seconds before restarting the engine.

■ **Customization**

If the smart key system has been deactivated in a customized setting, refer to P.654.

**⚠ WARNING****■ When starting the engine**

Always start the engine while sitting in the driver's seat. Do not depress the accelerator pedal while starting the engine under any circumstances.

Doing so may cause an accident resulting in death or serious injury.

**■ Caution while driving**

If engine failure occurs while the vehicle is moving, do not lock or open the doors until the vehicle reaches a safe and complete stop. Activation of the steering lock in this circumstance may lead to an accident, resulting in death or serious injury.

**⚠ NOTICE****■ When starting the engine**

● Do not race a cold engine.

● If the engine becomes difficult to start or stalls frequently, have your vehicle checked by your Toyota dealer immediately.

**■ Symptoms indicating a malfunction with the engine switch**

If the engine switch seems to be operating somewhat differently than usual, such as the switch sticking slightly, there may be a malfunction. Contact your Toyota dealer immediately.

**Stopping the engine**

- 1 Stop the vehicle completely.
- 2 If the parking brake is in manual mode, set the parking brake. (→P.203)

Check the parking brake indicator is illuminated.

3 Shift the shift lever to P.

4 Press the engine switch shortly and firmly.

The engine will stop, and the meter display will be extinguished.

5 Release the brake pedal and check that "ACCESSORY" or "IGNITION ON" is not shown on the multi-information display.

**■ Automatic engine shut off feature**

- The vehicle is equipped with a feature that automatically shuts off the engine when the shift lever is in P with the engine running for an extended period.
- The engine will automatically shut off after approximately 1 hour if it has been left running while the shift lever is in P.
- The timer for the automatic engine shut off feature will reset if the brake pedal is depressed or if the shift lever is in a position other than P.
- After the vehicle is parked, if the door is locked with the door lock switch (→P.112) from the inside or the mechanical key (→P.653) from the outside, the automatic engine shut off feature will be disabled. The timer for the automatic engine shut off feature will be re-enabled if the driver's door is opened.

**⚠ WARNING**

■ **Stopping the engine in an emergency**

- If you want to stop the engine in an emergency while driving the vehicle, press and hold the engine switch for more than 2 seconds, or press it briefly 3 times or more in succession. (→P.618)

However, do not touch the engine switch while driving except in an emergency. Turning the engine off while driving will not cause loss of steering or braking control, but the power assist to these systems will be lost. This will make it more difficult to steer and brake, so you should pull over and stop the vehicle as soon as it is safe to do so.

- If the engine switch is operated while the vehicle is running, a warning message will be shown on the multi-information display and a buzzer sounds.
- When restarting the engine after an emergency shutdown, shift the shift lever to N and press the engine switch shortly and firmly.

■ **When parking**

Exhaust gases include harmful carbon monoxide (CO), which is colorless and odorless. Observe the following precautions.

Failure to do so may cause exhaust gases to enter the vehicle and may lead to an accident caused by light-headedness, or may lead to death or a serious health hazard.

- If the vehicle is in a poorly ventilated area or a closed area, such as a garage, stop the engine.

- Do not leave the vehicle with the engine running for a long time. If such a situation cannot be avoided, park the vehicle in an open space and ensure that exhaust fumes do not enter the vehicle interior.

- Do not leave the engine running in an area with snow build-up, or where it is snowing. If snow-banks build up around the vehicle while the engine is running, exhaust gases may collect and enter the vehicle.

**Changing engine switch modes**

Modes can be changed by pressing the engine switch with brake pedal released. (The mode changes each time the switch is pressed.)

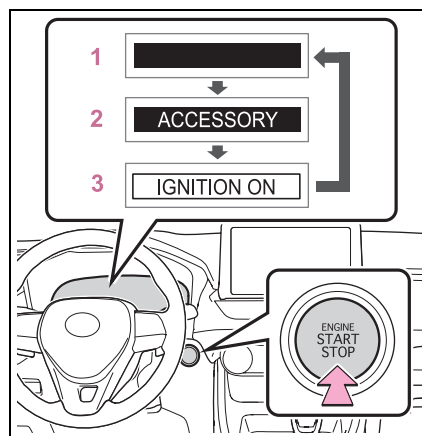

**1 OFF\***

The emergency flashers can be used.

The multi-information display will not be displayed.

**2 ACC**

Some electrical components such as the audio system can be used. "ACCESSORY" will be displayed on the multi-information display.

**3 ON**

All electrical components can be used.

"IGNITION ON" will be displayed on the multi-information display.

\*: If the shift lever is in a position other than P when turning off the engine, the engine switch will be turned to ACC, not to OFF.

**■ Auto power off function**

If the vehicle is left in ACC for more than 20 minutes or ON (the engine is not running) for more than an hour with the shift lever in P, the engine switch will automatically turn to OFF. However, this function cannot entirely prevent battery discharge. Do not leave the vehicle with the engine switch in ACC or ON for long periods of time when the engine is not running.

 NOTICE
<p><b>■ To prevent battery discharge</b></p> <ul style="list-style-type: none"> <li>● Do not leave the engine switch in ACC or ON for long periods of time without the engine running.</li> <li>● If "ACCESSORY" or "IGNITION ON" is displayed on the multi-information display, the engine switch is not in OFF. Exit the vehicle after turning the engine switch to OFF.</li> </ul>

**When stopping the engine with the shift lever in a position other than P**

If the engine is stopped with the shift lever in a position other

than P, the engine switch will not be turned to OFF but instead be turned to ACC. Perform the following procedure to turn the switch to OFF:

- 1 Check that the parking brake is set.
- 2 Shift the shift lever to P.
- 3 Check that "ACCESSORY" is displayed on the multi-information display and then press the engine switch shortly and firmly.
- 4 Check that "ACCESSORY" or "IGNITION ON" on the multi-information display is off.

 NOTICE
<p><b>■ To prevent battery discharge</b></p> <p>Do not stop the engine when the shift lever is in a position other than P. If the engine is stopped in another shift lever position, the engine switch will not be turned to OFF but instead be turned to ACC. If the vehicle is left in ACC, battery discharge may occur.</p>

Automatic transmission

Select the shift position depending on your purpose and situation.

Shift position purpose and functions

Shift position	Objective or function
P	Parking the vehicle/starting the engine
R	Reversing
N	Neutral
D	Normal driving <sup>*1</sup>
S	S mode driving <sup>*2</sup> (→P.201)

<sup>\*1</sup>: Shifting to the D position allows the system to select a gear suitable for the driving conditions. Setting the shift lever to the D position is recommended for normal driving.

<sup>\*2</sup>: Selecting shift ranges using S mode restricts the upper limit of the possible gear ranges, controls engine braking force, and prevents unnecessary upshifting.

■ When driving with dynamic radar cruise control with full-speed range activated

Even when performing the following actions with the intent of enabling engine braking, engine braking will not activate because dynamic radar cruise control with full-speed range

will not be canceled.

- While driving in S mode, downshifting to 7, 6, 5, or 4. (→P.201)
- When switching the driving mode to sport mode while driving in D. (→P.351)

■ If “High Transmission Fluid Temp See Owner’s Manual” is displayed on the multi-information display (AWD models)

Make sure to return to D position driving and reduce speed by easing off the accelerator pedal. Stop the vehicle in a safe place, shift the shift lever to P and let the engine idle until the warning message goes out.

When the warning message goes out, the vehicle can be driven again.

If the warning message does not go out after waiting a while, have your vehicle inspected by your Toyota dealer.

■ Restraining sudden start (Drive-Start Control)

→P.170

■ AI-SHIFT

The AI-SHIFT automatically selects the suitable gear according to driver performance and driving conditions. The AI-SHIFT automatically operates when the shift lever is in D. (Shifting the shift lever to S cancels the function.)

 **WARNING**

■ When driving on slippery road surfaces

Do not accelerate or shift gears suddenly. Sudden changes in engine braking may cause the vehicle to spin or skid, resulting in an accident.

**Shifting the shift lever**

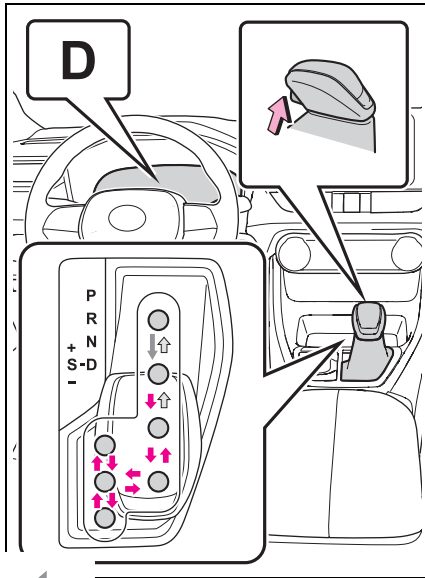

← While the engine switch is in ON and the brake pedal depressed\*, shift the shift lever while pushing the shift release button on the shift knob.

← Shift the shift lever while pushing the shift release button on the shift knob.

← Shift the shift lever normally.

When shifting the shift lever between P and D, make sure that the vehicle is completely stopped.

\*: For the vehicle to be able to be shifted from P, the brake pedal must be depressed before the shift release button is pushed. If the shift release button is pushed

first, the shift lock will not be released.

■ **Shift lock system**

The shift lock system is a system to prevent accidental operation of the shift lever in starting.

The shift lever can be shifted from P only when the engine switch is in ON, the brake pedal is depressed and the shift release button is pushed.

■ **If the shift lever cannot be shifted from P**

First, check whether the brake pedal is being depressed.

If the shift lever cannot be shifted even though the brake pedal is depressed and the shift release button is pushed, there may be a problem with the shift lock system. Have the vehicle inspected by your Toyota dealer immediately.

The following steps may be used as an emergency measure to ensure that the shift lever can be shifted.

Releasing the shift lock:

- 1 Pull the parking brake switch to check that the parking brake is set. (→P.203)
- 2 Turn the engine switch to OFF.
- 3 Depress the brake pedal.
- 4 Pry the cover up with a flathead screwdriver or equivalent tool. To prevent damage to the cover, cover the tip of the screwdriver with a rag.

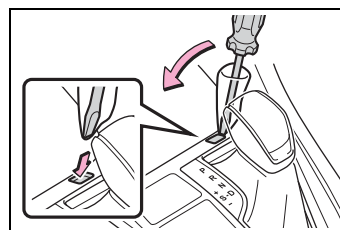

- 5 Press and hold the shift lock override button and then push the button on the shift knob.



The shift lever can be shifted while both buttons are pressed.

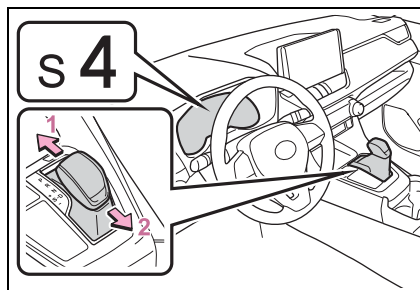
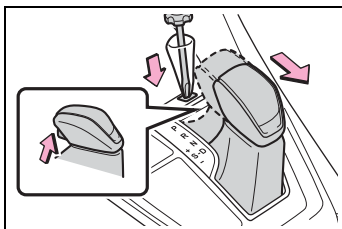

### ⚠ WARNING

#### ■ To prevent an accident when releasing the shift lock

Before pressing the shift lock override button, make sure to set the parking brake and depress the brake pedal.

If the accelerator pedal is accidentally depressed instead of the brake pedal when the shift lock override button is pressed and the shift lever is shifted out of P, the vehicle may suddenly start, possibly leading to an accident resulting in death or serious injury.

1 Upshifting

2 Downshifting

The selected shift range, from S1 to S8 will be displayed on the multi-information display.

The initial shift range in S mode is set automatically to 4, 5 or 6 according to vehicle speed.

However, the initial shift range may be set to 3 if AI-SHIFT has operated while the shift lever was in the D position. (→P.199)

### Selecting the driving mode and snow mode (if equipped)

→P.351, 357

### Changing shift ranges in S mode

When the shift lever is in the S position, the shift lever can be operated as follows:

#### ■ S mode

- You can choose from 8 levels of accelerating force and engine braking force.
- A lower shift range will provide greater accelerating force and engine braking force than a higher shift range, and the engine revolutions will also increase.
- To prevent the engine from over-revving, upshifting may automatically occur.
- To protect the automatic transmission, a function is adopted that automatically selects a higher shift range when the fluid temperature is high.
- When the shift range is 7 or lower, holding the shift lever toward “+” sets the shift range to 8.

■ **Downshifting restriction warning buzzer**

To help ensure safety and driving performance, downshifting operation may sometimes be restricted. In some circumstances, downshifting may not be possible even when the shift lever is operated. (A buzzer will sound twice.)

■ **If the “S” indicator does not come on or the “D” indicator is displayed even after shifting the shift lever to S**

This may indicate a malfunction in the automatic transmission system. Have the vehicle inspected by your Toyota dealer immediately. (In this situation, the transmission will operate in the same manner as when the shift lever is in D.)

Turn signal lever

Operating instructions

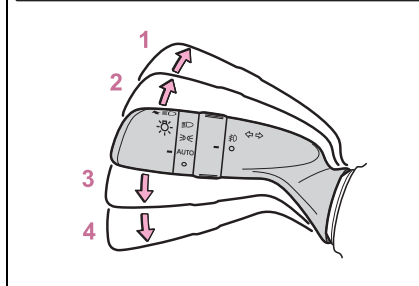
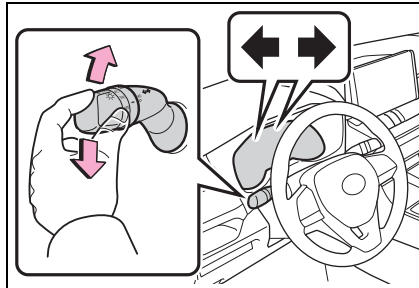

- 1 Right turn
- 2 Lane change to the right (move the lever partway and release it)  
The right hand signals will flash 3 times.
- 3 Lane change to the left (move the lever partway and release it)  
The left hand signals will flash 3 times.
- 4 Left turn

■ **Turn signals can be operated when**

The engine switch is in ON.

■ **If the indicator flashes faster than usual**

Check that a light bulb in the front or rear turn signal lights has not

burned out.

- **If the turn signals stop flashing before a lane change has been performed**

Operate the lever again.

- **To discontinue flashing of the turn signals during a lane change**

Operate the lever in the opposite direction.

### Parking brake

The parking brake can be set or released automatically or manually. In automatic mode, the parking brake can be set or released automatically according to shift lever operation. Also, even in automatic mode, the parking brake can be set or released manually.

### Operating instructions

- **Using the manual mode**

The parking brake can be set and released manually.

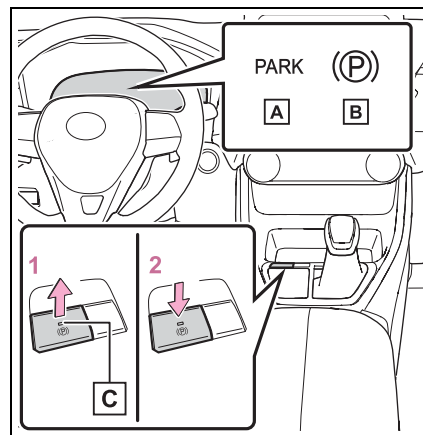

- A** Parking brake indicator light (U.S.A.)

- B** Parking brake indicator light (Canada)

- C** Parking brake switch indicator

- 1 Pull the switch to set the

parking brake.

The parking brake indicator light and parking brake switch indicator will turn on.

Pull and hold the parking brake switch if an emergency occurs and it is necessary to operate the parking brake while driving.

2 Push the switch to release the parking brake.

- Operate the parking brake switch while depressing the brake pedal.
- Parking brake automatic release function (→P.205)

Make sure that the parking brake indicator light and parking brake switch indicator turn off.

If the parking brake indicator light and parking brake switch indicator flash, operate the switch again. (→P.634)

#### ■ Turning the automatic mode on

While the vehicle is stopped, pull and hold the parking brake switch until a buzzer sounds and a message is shown on the multi-information display.

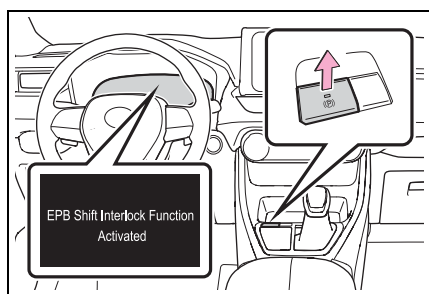

When the automatic mode is turned on, the parking brake operates as follows.

- When the shift position is shifted from P, the parking brake will be released, and the parking brake indicator light and parking brake switch indicator will turn off.
- When the shift position is shifted to P, the parking brake will be set, and the parking brake indicator light and parking brake switch indicator will turn on.

Operate the shift lever with the vehicle stopped and the brake pedal depressed.

#### ■ Turning the automatic mode off

While the vehicle is stopped and depressing the brake pedal, press and hold the parking brake switch until a buzzer sounds and a message is shown on the multi-information display.

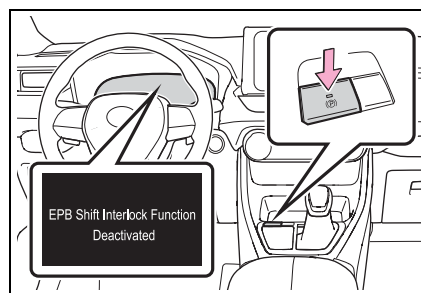

#### ■ Parking brake operation

- When the engine switch is not in ON, the parking brake cannot be released using the parking brake switch.
- When the engine switch is not in

ON, automatic mode (automatic brake setting and releasing) is not available.

#### ■ Parking brake automatic release function

The parking brake will be released automatically when the accelerator pedal is slowly depressed under the following conditions:

- The driver's door is closed
- The driver is wearing the seat belt
- The shift lever is in a forward or reverse position.
- The malfunction indicator lamp or brake system warning light is not illuminated

If the automatic release function does not operate, release the parking brake manually.

#### ■ If "Parking Brake Temporarily Unavailable" is displayed on the multi-information display

If the parking brake is operated repeatedly over a short period of time, the system may restrict operation to prevent overheating. If this happens, refrain from operating the parking brake. Normal operation will return after about 1 minute.

#### ■ If "Parking Brake Unavailable" is displayed on the multi-information display

Operate the parking brake switch. If the message does not disappear after operating the switch several times, the system may be malfunctioning. Have the vehicle inspected by your Toyota dealer.

#### ■ Parking brake operation sound

When the parking brake operates, a motor sound (whirring sound) may be heard. This does not indicate a malfunction.

#### ■ Parking brake indicator light

- Depending on the engine switch position/mode, the parking brake indicator light will turn on and stay

on as described below:

ON: Comes on until the parking brake is released.

Not in ON: Stays on for approximately 15 seconds.

- When the engine switch is turned off with the parking brake set, the parking brake indicator light will stay on for about 15 seconds. This does not indicate a malfunction.

#### ■ When the parking brake switch malfunctions

Automatic mode (automatic brake setting and releasing) will be turned on automatically.

#### ■ Parking the vehicle

→P.169

#### ■ Parking brake engaged warning buzzer

A buzzer will sound if the vehicle is driven with the parking brake engaged. "Parking Brake ON" is displayed on the multi-information display (with the vehicle reaching a speed of 5 km/h [3 mph]).

#### ■ If the brake system warning light comes on

→P.628

#### ■ Usage in winter time

→P.367



#### WARNING

##### ■ When parking the vehicle

Do not leave a child in the vehicle alone. The parking brake may be released unintentionally by a child and there is the danger of the vehicle moving that may lead to an accident resulting in death or serious injury.

##### ■ Parking brake switch

Do not set any objects near the parking brake switch. Objects may interfere with the switch and may lead the parking brake to unexpectedly operate.

 NOTICE

■ **When parking the vehicle**

Before you leave the vehicle, shift the shift position to P, set the parking brake and make sure that the vehicle does not move.

■ **When the system malfunctions**

Stop the vehicle in a safe place and check the warning messages.

■ **When the parking brake cannot be released due to a malfunction**

Driving the vehicle with the parking brake set will lead to brake components overheating, which may affect braking performance and increase brake wear. Have the vehicle inspected by your Toyota dealer immediately if this occurs.

## Brake Hold

**The brake hold system keeps the brake applied when the shift lever is in D, S or N with the system on and the brake pedal has been depressed to stop the vehicle. The system releases the brake when the accelerator pedal is depressed with the shift lever in D or S to allow smooth start off.**

### Enabling the system

Press the brake hold switch to turn the brake hold system on

The brake hold standby indicator (green) **A** comes on. While the system is holding the brake, the brake hold operated indicator (yellow) **B** comes on.

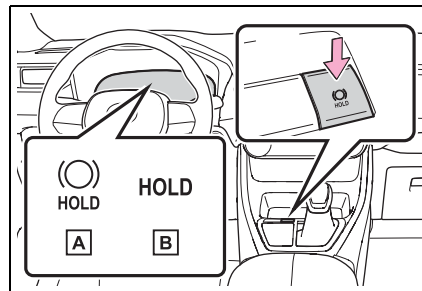

### ■ Brake hold system operating conditions

The brake hold system cannot be turned on in the following conditions:

- The driver's door is not closed.

- The driver is not wearing the seat belt.

If any of the conditions above are detected when the brake hold system is enabled, the system will turn off and the brake hold standby indicator light will go off. In addition, if any of the conditions are detected while the system is holding the brake, a warning buzzer will sound and a message will be shown on the multi-information display. The parking brake will then be set automatically.

#### ■ Brake hold function

- If the brake pedal is left released for a period of about 3 minutes after the system has started holding the brake, the parking brake will be set automatically. In this case, a warning buzzer sounds and a message is shown on the multi-information display.
- To turn the system off while the system is holding the brake, firmly depress the brake pedal and press the button again.
- The brake hold function may not hold the vehicle when the vehicle is on a steep incline. In this situation, it may be necessary for the driver to apply the brakes. A warning buzzer will sound and the multi-information display will inform the driver of this situation. If a warning message is shown on the multi-information display, read the message and follow the instructions.

#### ■ When the parking brake is set automatically while the system is holding the brakes

Perform any of the following operations to release the parking brake:

- Depress the accelerator pedal. (The parking brake will not be released automatically if the seat belt is not fastened.)
- Operate the parking brake switch with the brake pedal depressed.

Make sure that the parking brake indicator light goes off. (→P.203)

#### ■ When an inspection at your Toyota dealer is necessary

When the brake hold standby indicator (green) does not illuminate even when the brake hold switch is pressed with the brake hold system operating conditions met, the system may be malfunctioning. Have the vehicle inspected at your Toyota dealer.

#### ■ If “Brake Hold Malfunction Press Brake to Deactivate Visit Your Dealer” or “Brake Hold Malfunction Visit Your Dealer” is displayed on the multi-information display

The system may be malfunctioning. Have the vehicle inspected by your Toyota dealer.

#### ■ Warning messages and buzzers

Warning messages and buzzers are used to indicate a system malfunction or to inform the driver of the need for caution. If a warning message is shown on the multi-information display, read the message and follow the instructions.

#### ■ If the brake hold operated indicator flashes

→P.633

#### WARNING

##### ■ When the vehicle is on a steep incline

When using the brake hold system on a steep incline, exercise caution. The brake hold function may not hold the vehicle in such a situation.



**WARNING**

■ **When stopped on a slippery road**

The system cannot stop the vehicle when the gripping ability of the tires has been exceeded. Do not use the system when stopped on a slippery road.



**NOTICE**

■ **When parking the vehicle**

The brake hold system is not designed for use when parking the vehicle for a long period of time. Turning the engine switch off while the system is holding the brake may release the brake, which would cause the vehicle to move. When operating the engine switch, depress the brake pedal, shift the shift lever to P and set the parking brake.



Headlight switch

The headlights can be operated manually or automatically.

Turning on the headlights

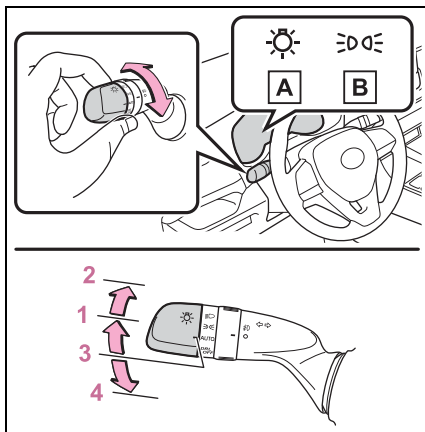

Operating the  switch turns on the lights as follows:

► Type A



**A** U.S.A.

**B** Canada





- 1  The side marker, parking, tail, license plate, instrument panel lights, and daytime running lights (→P.209) turn on.
- 2  The headlights and all lights listed above (except daytime running lights) turn on.
- 3  The headlights, daytime running lights (→P.209) and all the lights listed above turn

on and off automatically.

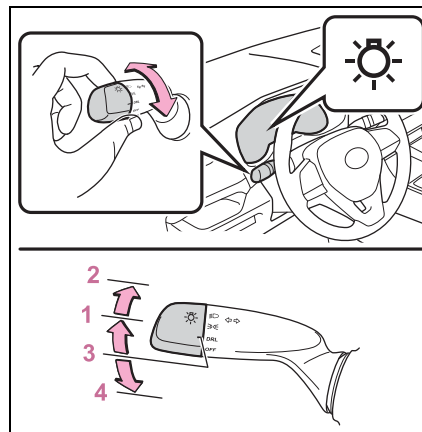
- 4  (U.S.A.) Off
  - (Canada) The daytime running lights turn on. (→P.209)

► Type B





- 1  The side marker, parking, tail, license plate, instrument panel lights, and daytime running lights (→P.209) turn on.
- 2  The headlights and all lights listed above (except daytime running lights) turn on.
- 3  The daytime running lights turn on. (→P.209)
- 4  Off

■ **AUTO mode can be used when**  
The engine switch is in ON.

■ **Daytime running light system**

- The daytime running lights illuminate using the same lights as the low beam headlight lights, and illuminate dimmer than the low beam headlight lights.

- To make your vehicle more visible to other drivers during daytime driving, the daytime running lights turn on automatically when all of the following conditions are met. (The daytime running lights are not designed for use at night.)
  - The engine is running
  - The parking brake is released
  - The headlight switch is in the  (Canada only), DRL,  or AUTO\* position

\*: When the surroundings are bright

The daytime running lights remain on after they illuminate, even if the parking brake is set again.

- For the U.S.A.: Daytime running lights can be turned off by operating the switch.
- Compared to turning on the headlights, the daytime running light system offers greater durability and consumes less electricity, so it can help improve fuel economy.

■ **Headlight control sensor (if equipped)**

The sensor may not function properly if an object is placed on the sensor, or anything that blocks the sensor is affixed to the windshield. Doing so interferes with the sensor detecting the level of ambient light and may cause the automatic headlight system to malfunction.

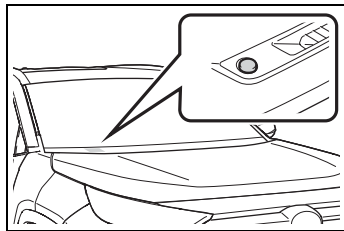



■ **Automatic light off system**

- When the headlights are on: The lights turn off 30 seconds after the engine switch is turned to ACC or OFF and a door is opened and

closed. (The lights turn off immediately if  on the key is pressed after all the doors are closed.)

- When only the tail lights are on: The tail lights turn off automatically if the engine switch is turned to ACC or OFF and the driver's door is opened.

To turn the lights on again, turn the engine switch to ON, or turn the light switch off once and then back to  or  position.

■ **Light reminder buzzer**

▶ Vehicles without smart key system  
A buzzer sounds when the engine switch is turned to ACC or OFF, the key is removed and the driver's door is opened while the lights are turned on.

▶ Vehicles with smart key system  
A buzzer sounds when the engine switch is turned to ACC or OFF and the driver's door is opened while the lights are turned on.

■ **Windshield wiper linked headlight illumination (if equipped)**

When driving during daytime with the headlight switch turned to AUTO, if the windshield wipers are used, the headlights will turn on automatically after several seconds to help enhance the visibility of your vehicle.

■ **Battery-saving function**

In order to prevent the battery of the vehicle from discharging, if the headlights and/or tail lights are on when the engine switch is turned to OFF, the battery saving function will operate and automatically turn off all the lights after approximately 20 minutes.

When any of the following are per-

formed, the battery-saving function is canceled once and then reactivated. All the lights will turn off automatically 20 minutes after the battery-saving function has been reactivated:

- When the headlight switch is operated
- When a door is opened or closed

■ **If “Headlight System Malfunction Visit Your Dealer” is displayed on the multi-information display**

The system may be malfunctioning. Have the vehicle inspected by your Toyota dealer.

■ **Customization**

Settings (e.g. light sensor sensitivity) can be changed.  
(Customizable features: →P.694)

	<p><b>NOTICE</b></p> <p>■ <b>To prevent battery discharge</b></p> <p>Do not leave the lights on longer than necessary when the engine is not running.</p>
---	---

**Turning on the high beam headlights**

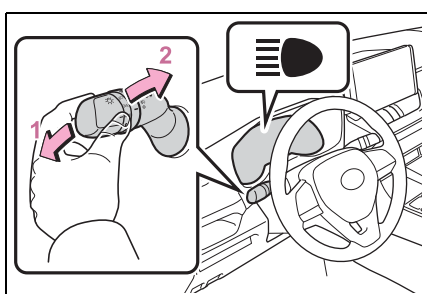

- 1 With the headlights on, push the lever away from you to turn on the high beams.

Pull the lever toward you to the center position to turn the high

beams off.

- 2 Pull the lever toward you and release it to flash the high beams once.

You can flash the high beams with the headlights on or off.

### AHB (Automatic High Beam)

The Automatic High Beam uses an in-vehicle camera sensor to assess the brightness of streetlights, the lights of vehicles ahead etc., and automatically turns the high beam on or off as necessary.

#### WARNING

##### ■ Limitations of the Automatic High Beam

Do not overly rely on the Automatic High Beam. Always drive safely, taking care to observe your surroundings and turning the high beam on or off manually if necessary.

##### ■ To prevent incorrect operation of the Automatic High Beam system

Do not overload the vehicle.

### Activating the Automatic High Beam system

- 1 Press the Automatic High Beam switch.

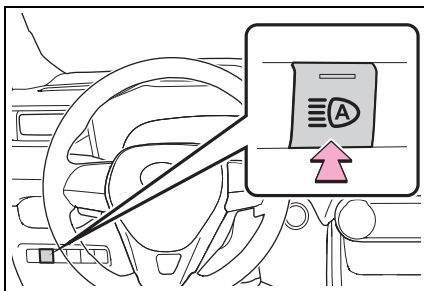

- 2 Push the lever away from you with the headlight switch in the AUTO or  position.

The Automatic High Beam indicator will come on when the system is operating.

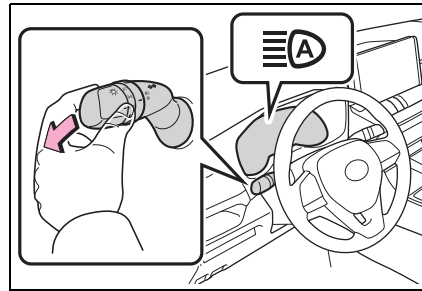

#### ■ High beam automatic turning on or off conditions

- When all of the following conditions are fulfilled, the high beam will be automatically turned on (after approximately 1 second):
  - Vehicle speed is above approximately 21 mph (34 km/h) or more.
  - The area ahead of the vehicle is dark.
  - There are no vehicles ahead with headlights or tail lights turned on.
  - There are few streetlights on the road ahead.
- If any of the following conditions are fulfilled, the high beam will be automatically turned off:
  - Vehicle speed drops below approximately 17 mph (27 km/h).
  - The area ahead of the vehicle is not dark.
  - Vehicles ahead have headlights or tail lights turned on.
  - There are many streetlights on the road ahead.

#### ■ Camera sensor detection information

- The high beam may not be automatically turned off in the following situations:
  - When oncoming vehicles suddenly appear from a curve

- When the vehicle is cut in front of by another vehicle
- When vehicles ahead are hidden from sight due to repeated curves, road dividers or roadside trees
- When vehicles ahead appear from the faraway lane on a wide road
- When vehicles ahead have no lights
- The high beam may be turned off if a vehicle ahead that is using fog lights without using the headlights is detected.
- House lights, street lights, traffic signals, and illuminated billboards or signs may cause the high beam to switch to the low beams, or the low beams to remain on.
- The following factors may affect the amount of time taken to turn the high beam on or off:
  - The brightness of headlights, fog lights, and tail lights of vehicles ahead
  - The movement and direction of vehicles ahead
  - When a vehicle ahead only has operational lights on one side
  - When a vehicle ahead is a two-wheeled vehicle
  - The condition of the road (gradient, curve, condition of the road surface etc.)
  - The number of passengers and amount of luggage
- The high beam may be turned on or off when the driver does not expect it.
- Bicycles or similar objects may not be detected.
- In the situations shown below, the system may not be able to accurately detect surrounding brightness levels. This may cause the low beams to remain on or the high beams to cause problems for pedestrians, vehicles ahead or other parties. In these cases, manually switch between the high and low beams.
- In bad weather (rain, snow, fog, sandstorms, etc.)
- The windshield is obscured by fog, mist, ice, dirt, etc.
- The windshield is cracked or damaged
- The camera sensor is deformed or dirty
- When the temperature of the camera sensor is extremely high
- Surrounding brightness levels are equal to those of headlights, tail lights or fog lights
- When headlights or tail lights of vehicles ahead are turned off, dirty, changing color, or not aimed properly
- When the vehicle is hit by water, snow, dust, etc. from a preceding vehicle
- When driving through an area of intermittently changing brightness and darkness
- When frequently and repeatedly driving ascending/descending roads, or roads with rough, bumpy or uneven surfaces (such as stone-paved roads, gravel roads, etc.)
- When frequently and repeatedly taking curves or driving on a winding road
- There is a highly reflective object ahead of the vehicle, such as a sign or mirror
- The back of a vehicle ahead is highly reflective, such as a container on a truck
- The vehicle's headlights are damaged or dirty, or are not aimed properly
- The vehicle is listing or titling due to a flat tire, a trailer being towed, etc.
- The high beam and low beam are repeatedly being switched between in an abnormal manner
- The driver believes that the high beam may be causing problems or distress to other drivers or pedestrians nearby

■ **If “Headlight System Malfunction Visit Your Dealer” is displayed on the multi-information display**

The system may be malfunctioning. Have the vehicle inspected by your Toyota dealer.

■ **Temporarily lowering sensor sensitivity**

The sensitivity of the sensor can be temporarily lowered.

1 Turn the engine switch off while the following conditions are met.

- The headlight switch is in  or AUTO position.
  - The headlight switch lever is in high beam position.
  - Automatic High Beam switch is on.
- 2 Turn the engine switch to ON.
- 3 Within 60 seconds after step 2, repeat pulling the headlight switch lever to the original position then pushing it to the high beam position quickly 10 times, then leave the lever in high beam position.
- 4 If the sensitivity is changed, the Automatic High Beam indicator is turn on and off 3 times.

Automatic High Beam (headlights) may turn on even when the vehicle is stopped.

**Turning the high beam on/off manually**

■ **Switching to the low beam**

Pull the lever to original position.

The Automatic High Beam indicator will turn off.

Push the lever away from you to activate the Automatic High Beam system again.

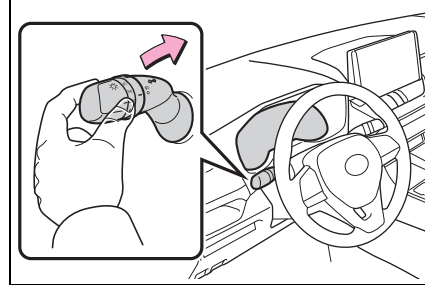

■ **Switching to the high beam**

Press the Automatic High Beam switch.

The Automatic High Beam indicator will turn off and the high beam indicator will turn on.

Press the switch to activate the Automatic High Beam system again.

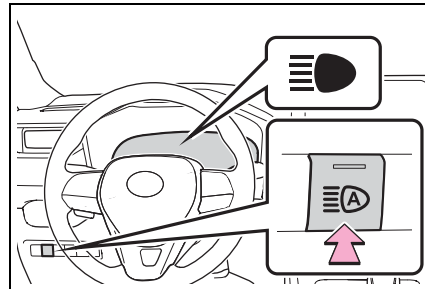

**Fog light switch\***

\*: If equipped

The fog lights offer improved visibility in difficult driving conditions, such as in rain and fog.

**Operating procedure**

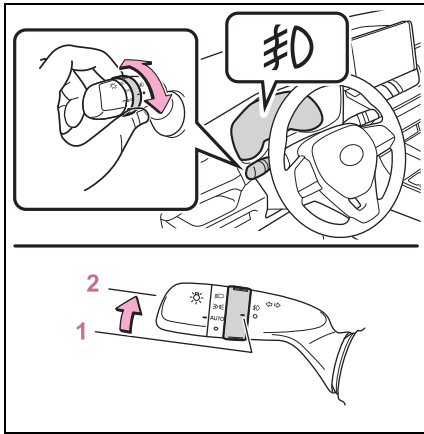

- 1 OFF\*<sup>1</sup> or ○ \*<sup>2</sup> Turns the fog lights off
- 2  $\text{F}$  Turns the fog lights on

\*<sup>1</sup>: For the U.S.A.  
\*<sup>2</sup>: For Canada

■ **Fog lights can be used when**  
The headlights are on in low beam.

**Windshield wipers and washer**

Operating the lever can switch between automatic operation and manual operation, or can use the washer.

NOTICE

■ **When the windshield is dry**  
Do not use the wipers, as they may damage the windshield.

**Operating the wiper lever**

Operating the lever operates the wipers or washer as follows:

► Intermittent windshield wipers

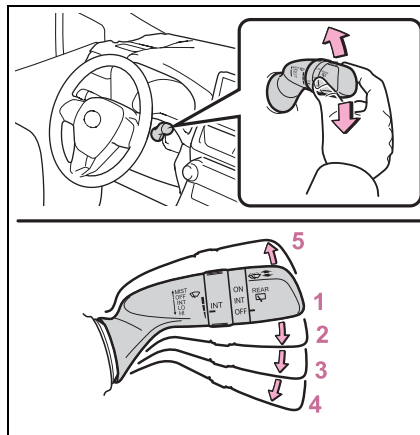

- 1 OFF \*<sup>1</sup> or ○ \*<sup>2</sup> Off
- 2 INT \*<sup>1</sup> or \*<sup>2</sup> Intermittent operation
- 3 LO \*<sup>1</sup> or ▼ \*<sup>2</sup> Low speed operation

4 HI <sup>\*1</sup> or ▼ <sup>\*2</sup> High speed operation

5 MIST <sup>\*1</sup> or △ <sup>\*2</sup> Temporary operation

<sup>\*1</sup>: For the U.S.A.

<sup>\*2</sup>: For Canada

If equipped, wiper intervals can be adjusted when intermittent operation is selected.

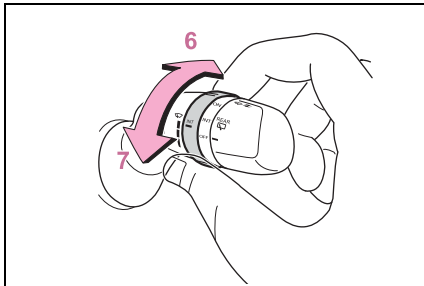

6 Increases the intermittent windshield wiper frequency

7 Decreases the intermittent windshield wiper frequency

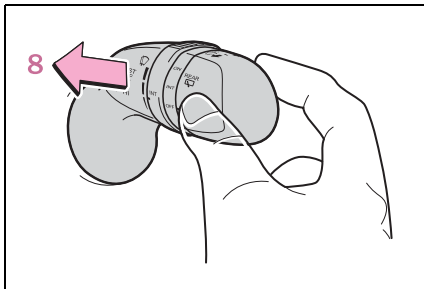

8  Washer/wiper dual operation

Pulling the lever operates the wipers and washer.

The wipers will automatically operate a couple of times after the washer squirts.

► Rain-sensing windshield wipers

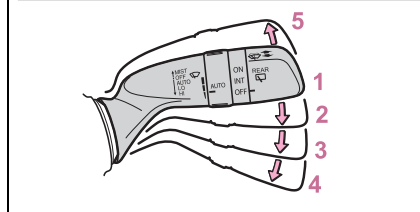
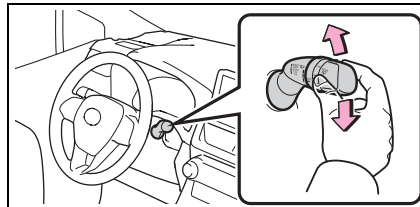

1 OFF <sup>\*1</sup> or ○ <sup>\*2</sup> Off

2 AUTO Rain-sensing operation

3 LO <sup>\*1</sup> or ▼ <sup>\*2</sup> Low speed operation

4 HI <sup>\*1</sup> or ▼ <sup>\*2</sup> High speed operation

5 MIST <sup>\*1</sup> or △ <sup>\*2</sup> Temporary operation

<sup>\*1</sup>: For the U.S.A.

<sup>\*2</sup>: For Canada

When “AUTO” is selected, the wipers will operate automatically when the sensor detects falling rain. The system automatically adjusts wiper timing in accordance with rain volume and vehicle speed.

The sensor sensitivity can be adjusted when “AUTO” is selected.



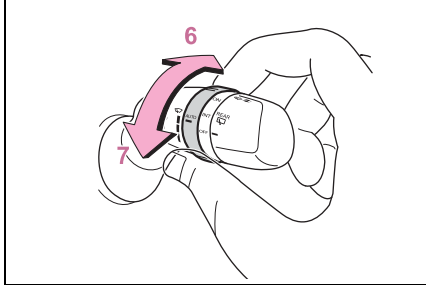

- 6 Increases the sensitivity
- 7 Decreases the sensitivity

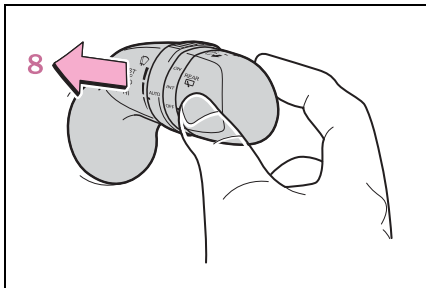

- 8  Washer/wiper dual operation  
Pulling the lever operates the wipers and washer.  
The wipers will automatically operate a couple of times after the washer squirts.

■ **The windshield wipers and washer can be operated when**

The engine switch is in ON.

■ **Raindrop sensor (vehicles with rain-sensing windshield wipers)**

- The raindrop sensor judges the amount of raindrops.

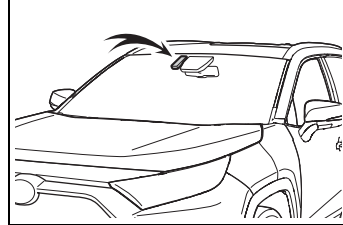

- If the wiper switch is turned to the "AUTO" position while the engine switch is in ON, the wipers will operate once to show that "AUTO" mode is activated.
- If the wiper sensitivity is adjusted to higher, the wiper may operate once to indicate the change of sensitivity.
- If the temperature of the raindrop sensor is 185°F (85°C) or higher, or 5°F (-15°C) or lower, the automatic operation may not occur. In this case, operate the wipers in any mode other than "AUTO".

■ **If no windshield washer fluid sprays**

Check that the washer nozzles are not blocked if there is washer fluid in the windshield washer fluid reservoir.

 **WARNING**

■ **Caution regarding the use of windshield wipers in "AUTO" mode (vehicles with rain-sensing windshield wipers)**

The windshield wipers may operate unexpectedly if the sensor is touched or the windshield is subject to vibration in "AUTO" mode. Take care that your fingers or anything else does not become caught in the windshield wipers.

**⚠ WARNING**

■ **Caution regarding the use of washer fluid**

When it is cold, do not use the washer fluid until the windshield becomes warm. The fluid may freeze on the windshield and cause low visibility. This may lead to an accident, resulting in death or serious injury.

**⚠ NOTICE**

■ **When the washer fluid tank is empty**

Do not operate the switch continually as the washer fluid pump may overheat.

■ **When a nozzle becomes blocked**

In this case, contact your Toyota dealer. Do not try to clear it with a pin or other object. The nozzle will be damaged.

■ **To prevent battery discharge**

Do not leave the wipers on longer than necessary when the engine is off.

Rear window wiper and washer

**Operating the lever can switch between automatic operation and manual operation, or can use the washer.**

**⚠ NOTICE**

■ **When the rear window is dry**

Do not use the wiper, as it may damage the rear window.

**Operating the wiper lever**

Operating the  switch operates the rear wiper as follows:

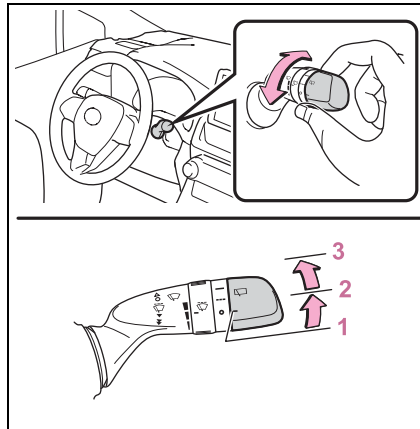

- 1 OFF <sup>\*1</sup> or ○ <sup>\*2</sup> Off
- 2 INT <sup>\*1</sup> or --- <sup>\*2</sup> Intermittent operation
- 3 ON <sup>\*1</sup> or — <sup>\*2</sup> Normal operation

<sup>\*1</sup>: For the U.S.A.

\*2: For Canada

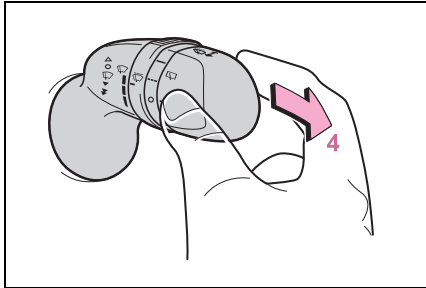

**4**  Washer/wiper dual operation

Pushing the lever operates the wiper and washer. The wiper will automatically operate a couple of times after the washer squirts.

■ **The rear window wiper and washer can be operated when**

The engine switch is in ON.

■ **If no washer fluid sprays**

Check that the washer nozzle is not blocked if there is washer fluid in the washer fluid reservoir.

■ **Back door opening linked rear window wiper stop function**

When the rear window wiper is operating, if the back door is opened while the vehicle is stopped, operation of the rear window wiper will be stopped to prevent anyone near the vehicle from being sprayed by water from the wiper. When the back door is closed, wiper operation will resume.\*

\*: The setting must be customized at your Toyota dealer.

■ **Reverse-linked rear window wiper function**

When the shift lever is shifted to R when the front wipers are operating, the rear window wiper will operate once.

■ **Customization**

Setting of the reverse-linked function can be changed. (Customizable features: →P.695)

 NOTICE

■ **When the washer fluid tank is empty**

Do not operate the switch continually as the washer fluid pump may overheat.

■ **When a nozzle becomes blocked**

In this case, contact your Toyota dealer. Do not try to clear it with a pin or other object. The nozzle will be damaged.

■ **To prevent battery discharge**

Do not leave the wiper on longer than necessary when the engine is off.

## Opening the fuel tank cap

**Perform the following steps to open the fuel tank cap:**

### Before refueling the vehicle

- Close all the doors and windows, and turn the engine switch to OFF.
- Confirm the type of fuel.

#### ■ Fuel types

→P.676

#### ■ Fuel tank opening for unleaded gasoline

To help prevent incorrect fueling, your vehicle has a fuel tank opening that only accommodates the special nozzle on unleaded fuel pumps.

#### ■ If the malfunction indicator lamp illuminates

The malfunction indicator lamp may illuminate erroneously if refueling is performed repeatedly when the fuel tank is nearly full.

## WARNING

### ■ When refueling the vehicle

Observe the following precautions while refueling the vehicle. Failure to do so may result in death or serious injury.

- After exiting the vehicle and before opening the fuel door, touch an unpainted metal surface to discharge any static electricity. It is important to discharge static electricity before refueling because sparks resulting from static electricity can cause fuel vapors to ignite while refueling.
- Always hold the grips on the fuel tank cap and turn it slowly to remove it.  
A whooshing sound may be heard when the fuel tank cap is loosened. Wait until the sound cannot be heard before fully removing the cap. In hot weather, pressurized fuel may spray out of the filler neck and cause injury.
- Do not allow anyone that has not discharged static electricity from their body to come close to an open fuel tank.
- Do not inhale vaporized fuel. Fuel contains substances that are harmful if inhaled.
- Do not smoke while refueling the vehicle. Doing so may cause the fuel to ignite and cause a fire.
- Do not return to the vehicle or touch any person or object that is statically charged. This may cause static electricity to build up, resulting in a possible ignition hazard.

**⚠ WARNING**

**■ When refueling**  
 Observe the following precautions to prevent fuel overflowing from the fuel tank:

- Securely insert the fuel nozzle into the fuel filler neck.
- Stop filling the tank after the fuel nozzle automatically clicks off.
- Do not top off the fuel tank.

**⚠ NOTICE**

**■ Refueling**  
 Do not spill fuel during refueling. Doing so may damage the vehicle, such as causing the emission control system to operate abnormally or damaging fuel system components or the vehicle's painted surface.

**Opening the fuel tank cap**

- 1 Pull up the opener to open the fuel filler door.

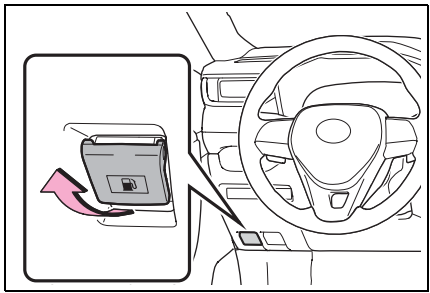

- 2 Turn the fuel tank cap slowly to open it and put it into the holder on the fuel filler door.

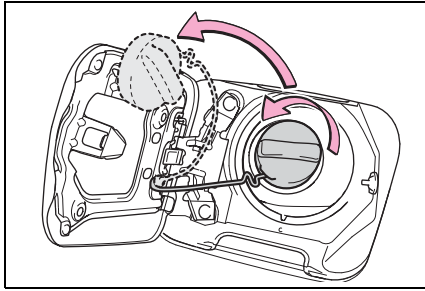

**Closing the fuel tank cap**

After refueling, turn the fuel tank cap until you hear a click. Once the cap is released, it will turn slightly in the opposite direction.

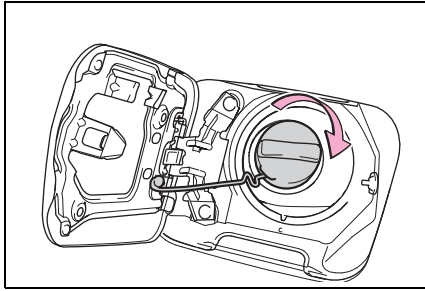

**■ When "Check Fuel Cap" is displayed on the multi-information display**

The fuel tank cap may be unfastened or loose. Turn the engine switch off, check the cap and tighten it securely. If the message remains, wait a few seconds and then turn the engine switch off once again.



**WARNING**

■ **When replacing the fuel tank cap**

Do not use anything but a genuine Toyota fuel tank cap designed for your vehicle. Doing so may cause a fire or other incident which may result in death or serious injury.

**Toyota Safety Sense 2.0**

**The Toyota Safety Sense 2.0 consists of the following drive assist systems and contributes to a safe and comfortable driving experience:**

**Driving assist system**

- **PCS (Pre-Collision System)**  
→P.229
- **LTA (Lane Tracing Assist)**  
→P.237
- **AHB (Automatic High Beam)**  
→P.212
- **RSA (Road Sign Assist) (if equipped)**  
→P.247
- **Dynamic radar cruise control with full-speed range**  
→P.250

**! WARNING**

**■ Toyota Safety Sense 2.0**

The Toyota Safety Sense 2.0 is designed to operate under the assumption that the driver will drive safely, and is designed to help reduce the impact to the occupants and the vehicle in the case of a collision or assist the driver in normal driving conditions.

As there is a limit to the degree of recognition accuracy and control performance that this system can provide, do not overly rely on this system. The driver is always responsible for paying attention to the vehicle's surroundings and driving safely.

**Sensors**

Two types of sensors, located behind the front grille and windshield, detect information necessary to operate the drive assist systems.

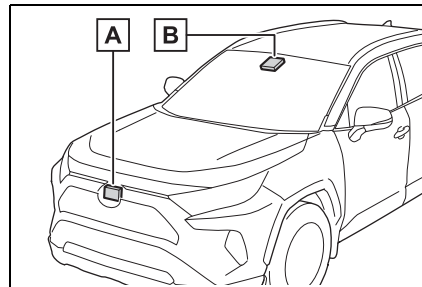

**A** Radar sensor

**B** Front camera

**⚠ WARNING****■ To avoid malfunction of the radar sensor**

Observe the following precautions. Otherwise, the radar sensor may not operate properly, possibly leading to an accident resulting in death or serious injury.

- Keep the radar sensor and the radar sensor cover clean at all times.

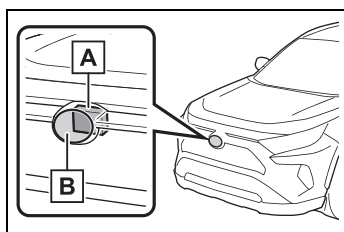

**A** Radar sensor

**B** Radar sensor cover

If the front of the radar sensor or the front or back of the radar sensor cover is dirty or covered with water droplets, snow, etc., clean it.

Clean the radar sensor and radar sensor cover with a soft cloth to avoid damaging them.

- Do not attach accessories, stickers (including transparent stickers) or other items to the radar sensor, radar sensor cover or surrounding area.
- Do not subject the radar sensor or its surrounding area to a strong impact. If the radar sensor, front grille, or front bumper has been subjected to a strong impact, have the vehicle inspected by your Toyota dealer.

- Do not disassemble the radar sensor.
- Do not modify or paint the radar sensor or radar sensor cover.
- In the following cases, the radar sensor must be recalibrated. Contact your Toyota dealer for details.
  - When the radar sensor or front grille are removed and installed, or replaced
  - When the front bumper is replaced

**■ To avoid malfunction of the front camera**

Observe the following precautions. Otherwise, the front camera may not operate properly, possibly leading to an accident resulting in death or serious injury.

- Keep the windshield clean at all times.
  - If the windshield is dirty or covered with an oily film, water droplets, snow, etc., clean the windshield.
  - If a glass coating agent is applied to the windshield, it will still be necessary to use the windshield wipers to remove water droplets, etc. from the area of the windshield in front of the front camera.
  - If the inner side of the windshield where the front camera is installed is dirty, contact your Toyota dealer.



**⚠ WARNING**

- Do not attach objects, such as stickers, transparent stickers, etc., to the outer side of the windshield in front of the front camera (shaded area in the illustration).

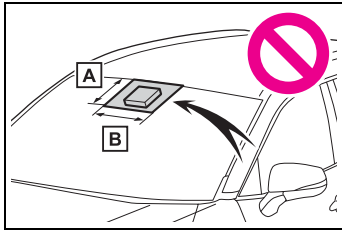

**A** From the top of the windshield to approximately 0.4 in. (1 cm) below the bottom of the front camera

**B** Approximately 7.9 in. (20 cm) (Approximately 4.0 in. [10 cm] to the right and left from the center of the front camera)

- If the part of the windshield in front of the front camera is fogged up or covered with condensation, or ice, use the windshield defogger to remove the fog, condensation, or ice. (→P.511, 517)
- If water droplets cannot be properly removed from the area of the windshield in front of the front camera by the windshield wipers, replace the wiper insert or wiper blade.
- Do not attach window tint to the windshield.
- Replace the windshield if it is damaged or cracked. After replacing the windshield, the front camera must be recalibrated. Contact your Toyota dealer for details.

- Do not allow liquids to contact the front camera.
- Do not allow bright lights to shine into the front camera.
- Do not dirty or damage the front camera. When cleaning the inside of the windshield, do not allow glass cleaner to contact the lens of the front camera. Also, do not touch the lens. If the lens is dirty or damaged, contact your Toyota dealer.
- Do not subject the front camera to a strong impact.
- Do not change the installation position or direction of the front camera or remove it.
- Do not disassemble the front camera.
- Do not modify any components of the vehicle around the front camera (inside rear view mirror, etc.) or ceiling.
- Do not attach any accessories to the hood, front grille or front bumper that may obstruct the front camera. Contact your Toyota dealer for details.
- If a surfboard or other long object is to be mounted on the roof, make sure that it will not obstruct the front camera.
- Do not modify the headlights or other lights.

■ **Certification**

- ▶ For vehicles sold in the U.S.A., Hawaii, American Samoa, Guam, Saipan and Puerto Rico

FCC ID: HYQDNMWR009

**NOTE:**

This device complies with part 15 of the FCC Rules. Operation is subject to the following two conditions: (1) This device may not cause harmful interference, and (2) this device must accept any interference received, including interference that may cause undesired operation.

**FCC WARNING:**

Changes or modifications not expressly approved by the party responsible for compliance could void the user's authority to operate the equipment.

**Radiofrequency radiation exposure Information:**

This equipment complies with FCC radiation exposure limits set forth for an uncontrolled environment. This equipment should be installed and operated with minimum distance of 20 cm between the radiator (antenna) and your body. This transmitter must not be co-located or operating in conjunction with any other antenna or transmitter.

- ▶ For vehicles sold in Canada

**NOTE:**

This device contains licence-exempt transmitter(s)/receiver(s) that comply with Innovation, Science and Economic Development Canada's licence-exempt RSS(s). Operation is subject to the following two conditions:

- (1) This device may not cause interference.
- (2) This device must accept any interference, including interference that may cause undesired operation of the device.

This equipment complies with IC radiation exposure limits set forth for an uncontrolled environment and meets RSS-102 of the IC radio frequency (RF) Exposure rules. This equipment should be installed and operated keeping the radiator at least 20 cm or more away from person's body.

**NOTE:**

L'émetteur/récepteur exempt de licence contenu dans le présent appareil est conforme aux CNR d'Innovation, Sciences et Développement économique Canada applicables aux appareils radio exempts de licence. L'exploitation est autorisée aux deux conditions suivantes :

- 1) L'appareil ne doit pas produire de brouillage;
- 2) L'appareil doit accepter tout brouillage radioélectrique subi, même si le brouillage est susceptible d'en compromettre le fonctionnement.

Cet équipement est conforme aux limites d'exposition aux rayonnements énoncées pour un environnement non contrôlé et respecte les règles d'exposition aux fréquences radioélectriques (RF) CNR-102 de l'IC. Cet équipement doit être installé et utilisé en gardant une distance de 20 cm ou plus entre le dispositif rayonnant et le corps.

**■ If a warning message is displayed on the multi-information display**

A system may be temporarily unavailable or there may be a malfunction in the system.

- In the following situations, perform the actions specified in the table. When the normal operating conditions are detected, the message will disappear and the system will become operational.

If the message does not disappear, contact your Toyota dealer.

Situation	Actions
When the area around a sensor is covered with dirt, moisture (fogged up, covered with condensation, ice, etc.), or other foreign matter	To clean the part of the windshield in front of the front camera, use the windshield wipers or the windshield defogger of the air conditioning system (→P.511, 517).

Situation	Actions
When the temperature around the front camera is outside of the operational range, such as when the vehicle is in the sun or in an extremely cold environment	<p>If the front camera is hot, such as after the vehicle had been parked in the sun, use the air conditioning system to decrease the temperature around the front camera.</p> <p>If a sunshade was used when the vehicle was parked, depending on its type, the sunlight reflected from the surface of the sunshade may cause the temperature of the front camera to become excessively high.</p> <p>If the front camera is cold, such as after the vehicle is parked in an extremely cold environment, use the air conditioning system to increase the temperature around the front camera.</p>
The area in front of the front camera is obstructed, such as when the hood is open or a sticker is attached to the part of the windshield in front of the front camera.	Close the hood, remove the sticker, etc. to clear the obstruction.

- In the following situations, if the situation has changed (or the vehicle has been driven for some time) and the normal operating conditions are detected, the message will disappear and the system will become operational.

If the message does not disappear, contact your Toyota dealer.

- When the temperature around the radar sensor is outside of the operational range, such as when the vehicle is in the sun or in an extremely cold environment
- When the front camera cannot detect objects in front of the vehicle, such as when driving in the dark, snow, or fog, or when bright lights are shining into the front camera

## PCS (Pre-Collision System)

**The pre-collision system uses a radar sensor and front camera to detect objects (→P.229) in front of the vehicle. When the system determines that the possibility of a frontal collision with an object is high, a warning operates to urge the driver to take evasive action and the potential brake pressure is increased to help the driver avoid the collision. If the system determines that the possibility of a frontal collision with an object is extremely high, the brakes are automatically applied to help avoid the collision or help reduce the impact of the collision.**

The pre-collision system can be disabled/enabled and the warning timing can be changed. (→P.231)

## Detectable objects

The system can detect the following:

- Vehicles
- Bicyclists
- Pedestrians

## System functions

### ■ Pre-collision warning

When the system determines that the possibility of a frontal collision is high, a buzzer will sound and a warning message will be displayed on the multi-information display to urge the driver to take evasive action.

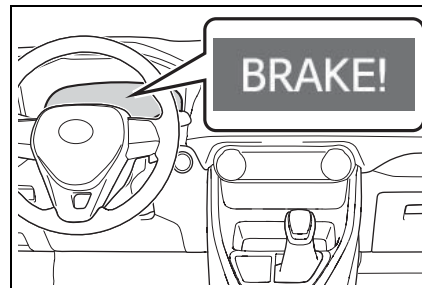

### ■ Pre-collision brake assist

When the system determines that the possibility of a frontal collision is high, the system applies greater braking force in relation to how strongly the brake pedal is depressed.

### ■ Pre-collision braking

If the system determines that the possibility of a frontal collision is extremely high, the brakes are automatically applied to help avoid the collision or reduce the impact of the collision.

**⚠ WARNING****■ Limitations of the pre-collision system**

- The driver is solely responsible for safe driving. Always drive safely, taking care to observe your surroundings. Do not use the pre-collision system instead of normal braking operations under any circumstances. This system will not prevent collisions or lessen collision damage or injury in every situation. Do not overly rely on this system. Failure to do so may lead to an accident, resulting in death or serious injury.
- Although this system is designed to help avoid a collision or help reduce the impact of the collision, its effectiveness may change according to various conditions, therefore the system may not always be able to achieve the same level of performance. Read the following conditions carefully. Do not overly rely on this system and always drive carefully.
- Conditions under which the system may operate even if there is no possibility of a collision: →P.233
- Conditions under which the system may not operate properly: →P.234
- Do not attempt to test the operation of the pre-collision system yourself. Depending on the objects used for testing (dummies, cardboard objects imitating detectable objects, etc.), the system may not operate properly, possibly leading to an accident.

**■ Pre-collision braking**

- When the pre-collision braking function is operating, a large amount of braking force will be applied.
- If the vehicle is stopped by the operation of the pre-collision braking function, the pre-collision braking function operation will be canceled after approximately 2 seconds. Depress the brake pedal as necessary.
- The pre-collision braking function may not operate if certain operations are performed by the driver. If the accelerator pedal is being depressed strongly or the steering wheel is being turned, the system may determine that the driver is taking evasive action and possibly prevent the pre-collision braking function from operating.
- In some situations, while the pre-collision braking function is operating, operation of the function may be canceled if the accelerator pedal is depressed strongly or the steering wheel is turned and the system determines that the driver is taking evasive action.
- If the brake pedal is being depressed, the system may determine that the driver is taking evasive action and possibly delay the operation timing of the pre-collision braking function.

**■ When to disable the pre-collision system**

In the following situations, disable the system, as it may not operate properly, possibly leading to an accident resulting in death or serious injury:

- When the vehicle is being towed

**⚠ WARNING**

- When your vehicle is towing another vehicle
- When transporting the vehicle via truck, boat, train or similar means of transportation
- When the vehicle is raised on a lift with the engine running and the tires are allowed to rotate freely
- When inspecting the vehicle using a drum tester such as a chassis dynamometer or speedometer tester, or when using an on vehicle wheel balancer
- When a strong impact is applied to the front bumper or front grille, due to an accident or other reasons
- If the vehicle cannot be driven in a stable manner, such as when the vehicle has been in an accident or is malfunctioning
- When the vehicle is driven in a sporty manner or off-road
- When the tires are not properly inflated
- When the tires are very worn
- When tires of a size other than specified are installed
- When tire chains are installed
- When a compact spare tire or an emergency tire puncture repair kit is used
- If equipment (snow plow, etc.) that may obstruct the radar sensor or front camera is temporarily installed to the vehicle

**Changing settings of the pre-collision system****■ Enabling/disabling the pre-collision system**

The pre-collision system can be enabled/disabled on the  screen (→P.94) of the multi-information display.

The system is automatically enabled each time the engine switch is turned to ON.

If the system is disabled, the PCS warning light will turn on and a message will be displayed on the multi-information display.

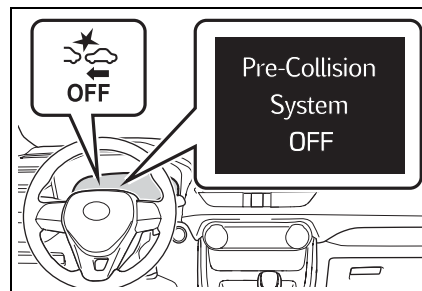
**■ Changing the pre-collision warning timing**

The pre-collision warning timing can be changed on the  screen (→P.94) of the multi-information display.

The warning timing setting is retained when the engine switch is turned to OFF. However, if the pre-collision system is disabled and re-enabled, the operation timing will return to the default setting (middle).

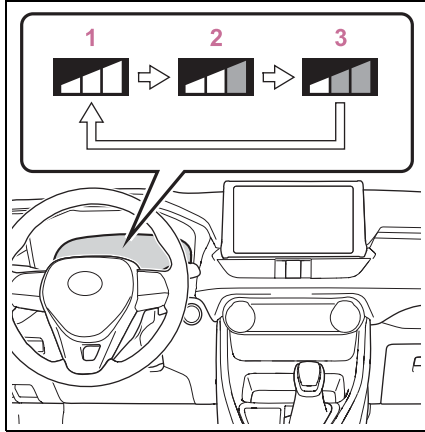

- 2 Middle  
This is the default setting.
- 3 Late

1 Early

■ **Operational conditions**

The pre-collision system is enabled and the system determines that the possibility of a frontal collision with a detected object is high. Each function is operational at the following speed

● Pre-collision warning

Detectable objects	Vehicle speed	Relative speed between your vehicle and object
Vehicles	Approx. 7 to 110 mph (10 to 180 km/h)	Approx. 7 to 110 mph (10 to 180 km/h)
Bicyclists and pedestrians	Approx. 7 to 50 mph (10 to 80 km/h)	Approx. 7 to 50 mph (10 to 80 km/h)

● Pre-collision brake assist

Detectable objects	Vehicle speed	Relative speed between your vehicle and object
Vehicles	Approx. 20 to 110 mph (30 to 180 km/h)	Approx. 20 to 110 mph (30 to 180 km/h)
Bicyclists and pedestrians	Approx. 20 to 50 mph (30 to 80 km/h)	Approx. 20 to 50 mph (30 to 80 km/h)



● Pre-collision braking

Detectable objects	Vehicle speed	Relative speed between your vehicle and object
Vehicles	Approx. 7 to 110 mph (10 to 180 km/h)	Approx. 7 to 110 mph (10 to 180 km/h)
Bicyclists and pedestrians	Approx. 7 to 50 mph (10 to 80 km/h)	Approx. 7 to 50 mph (10 to 80 km/h)

The system may not operate in the following situations:

- If a battery terminal has been disconnected and reconnected and then the vehicle has not been driven for a certain amount of time
- If the shift lever is in R
- When the VSC OFF indicator is illuminated (only the pre-collision warning function will be operational)

■ Object detection function

The system detects objects based on their size, profile, motion, etc. However, an object may not be detected depending on the surrounding brightness and the motion, posture, and angle of the detected object, preventing the system from operating properly. (→P.234)  
The illustration shows an image of detectable objects.

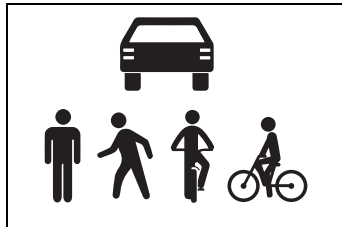

■ Cancellation of the pre-collision braking

If either of the following occur while the pre-collision braking function is operating, it will be canceled:

- The accelerator pedal is depressed strongly.
- The steering wheel is turned sharply or abruptly.

■ Conditions under which the system may operate even if there is no possibility of a collision

- In some situations such as the following, the system may determine that there is a possibility of a frontal collision and operate.
  - When passing a detectable object, etc.
  - When changing lanes while overtaking a detectable object, etc.
  - When approaching a detectable object in an adjacent lane or on the roadside, such as when changing the course of travel or driving on a winding road

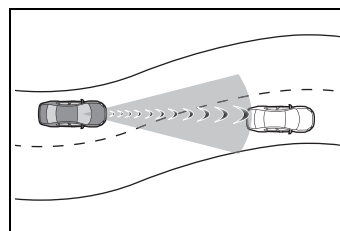

- When rapidly closing on a detectable object, etc.
- When approaching objects on the roadside, such as detectable objects, guardrails, utility poles, trees, or walls
- When there is a detectable object or other object by the roadside at

the entrance of a curve

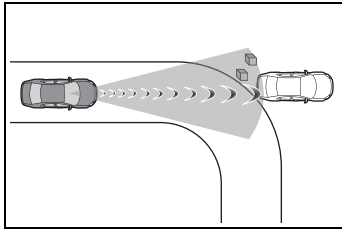

- When there are patterns or paint in front of your vehicle that may be mistaken for a detectable object
- When the front of your vehicle is hit by water, snow, dust, etc.
- When overtaking a detectable object that is changing lanes or making a right/left turn

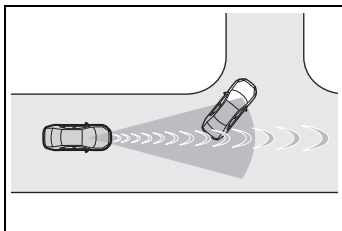

- When passing a detectable object in an oncoming lane that is stopped to make a right/left turn

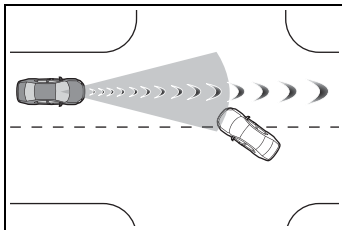

- When a detectable object approaches very close and then stops before entering the path of your vehicle
- If the front of your vehicle is raised or lowered, such as when on an uneven or undulating road surface
- When driving on a road surrounded by a structure, such as in a tunnel or on an iron bridge
- When there is a metal object (manhole cover, steel plate, etc.), steps, or a protrusion in front of

your vehicle

- When passing under an object (road sign, billboard, etc.)

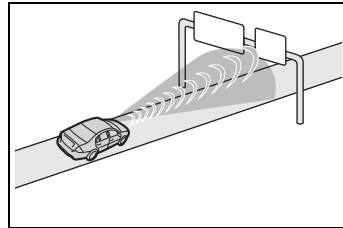

- When approaching an electric toll gate barrier, parking area barrier, or other barrier that opens and closes
- When using an automatic car wash
- When driving through or under objects that may contact your vehicle, such as thick grass, tree branches, or a banner

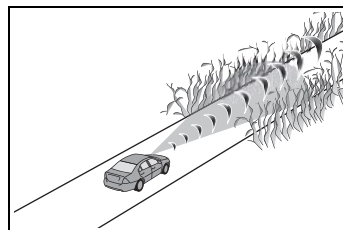

- When driving through steam or smoke
- When driving near an object that reflects radio waves, such as a large truck or guardrail
- When driving near a TV tower, broadcasting station, electric power plant, or other location where strong radio waves or electrical noise may be present

■ **Situations in which the system may not operate properly**

- In some situations such as the following, an object may not be detected by the radar sensor and front camera, preventing the system from operating properly:
  - When a detectable object is approaching your vehicle
  - When your vehicle or a detectable object is wobbling

- If a detectable object makes an abrupt maneuver (such as sudden swerving, acceleration or deceleration)
- When your vehicle approaches a detectable object rapidly
- When a detectable object is not directly in front of your vehicle

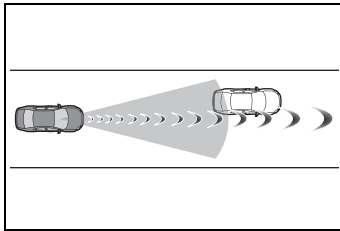

- When a detectable object is near a wall, fence, guardrail, manhole cover, vehicle, steel plate on the road, etc.
- When a detectable object is under a structure
- When part of a detectable object is hidden by an object, such as large baggage, an umbrella, or guardrail
- When multiple detectable objects are close together
- If the sun or other light is shining directly on a detectable object
- When a detectable object is a shade of white and looks extremely bright
- When a detectable object appears to be nearly the same color or brightness as its surroundings
- If a detectable object cuts or suddenly emerges in front of your vehicle
- When the front of your vehicle is hit by water, snow, dust, etc.
- When a very bright light ahead, such as the sun or the headlights of oncoming traffic, shines directly into the front camera
- When approaching the side or front of a vehicle ahead
- If a vehicle ahead is a motorcycle
- If a vehicle ahead is narrow, such as a personal mobility vehicle
- If a preceding vehicle has a small rear end, such as an unloaded

truck

- If a preceding vehicle has a low rear end, such as a low bed trailer

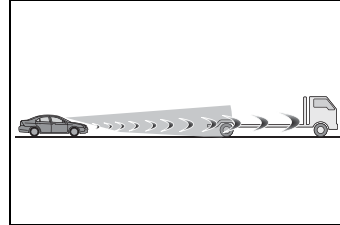

- If a vehicle ahead has extremely high ground clearance

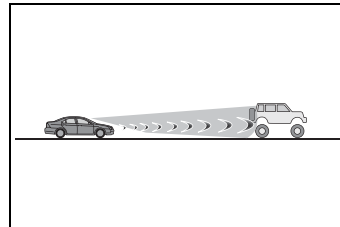

- If a vehicle ahead is carrying a load which protrudes past its rear bumper
- If a vehicle ahead is irregularly shaped, such as a tractor or side car
- If a vehicle ahead is a child sized bicycle, a bicycle that is carrying a large load, a bicycle ridden by more than one person, or a uniquely shaped bicycle (bicycle with a child seat, tandem bicycle, etc.)
- If a pedestrian/or the riding height of a bicyclist ahead is shorter than approximately 3.2 ft. (1 m) or taller than approximately 6.5 ft. (2 m)
- If a pedestrian/bicyclist is wearing oversized clothing (a rain coat, long skirt, etc.), making their silhouette obscure
- If a pedestrian is bending forward or squatting or bicyclist is bending forward
- If a pedestrian/bicyclist is moving fast
- If a pedestrian is pushing a stroller, wheelchair, bicycle or other vehicle
- When driving in inclement weather

- such as heavy rain, fog, snow or a sandstorm
- When driving through steam or smoke
- When the surrounding area is dim, such as at dawn or dusk, or while at night or in a tunnel, making a detectable object appear to be nearly the same color as its surroundings
- When driving in a place where the surrounding brightness changes suddenly, such as at the entrance or exit of a tunnel
- After the engine has started the vehicle has not been driven for a certain amount of time
- While making a left/right turn and for a few seconds after making a left/right turn
- While driving on a curve and for a few seconds after driving on a curve
- If your vehicle is skidding
- If the front of the vehicle is raised or lowered

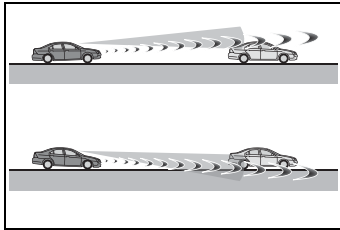

- If the vehicle is not properly maintained (brakes or tires are excessively worn, improper tire inflation pressure, etc.)
  - When the vehicle is being driven on a gravel road or other slippery surface
- **If VSC is disabled**
- If VSC is disabled (→P.362), the pre-collision brake assist and pre-collision braking functions are also disabled.
  - The PCS warning light will turn on and “VSC Turned Off Pre-Collision Brake System Unavailable” will be displayed on the multi-information display.
- If the wheels are misaligned
  - If a wiper blade is blocking the front camera
  - The vehicle is being driven at extremely high speeds
  - When driving on a hill
  - If the radar sensor or front camera is misaligned
- In some situations such as the following, sufficient braking force may not be obtained, preventing the system from performing properly:
- If the braking functions cannot operate to their full extent, such as when the brake parts are extremely cold, extremely hot, or wet

**LTA (Lane Tracing Assist)**

**When driving on highways and freeways with white (yellow) lane lines, this function alerts the driver when the vehicle might depart from its lane or course\* and provides assistance by operating the steering wheel to keep the vehicle in its lane or course\*. Furthermore, the system provides steering assistance when dynamic radar cruise control with full-speed range is operating to keep the vehicle in its lane.**

**The LTA system recognizes white (yellow) lane lines or a course\* using the front camera. Additionally, it detects preceding vehicles using the front camera and radar.**

\*: Boundary between asphalt and the side of the road, such as grass, soil, or a curb

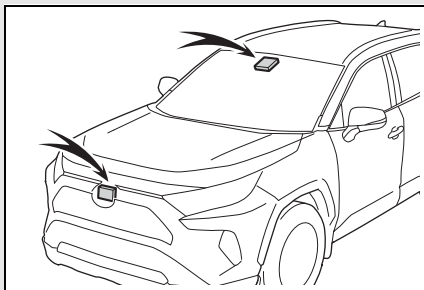

**⚠ WARNING**

**■ Before using LTA system**

● Do not rely solely upon the LTA system. The LTA system does not automatically drive the vehicle or reduce the amount of attention that must be paid to the area in front of the vehicle. The driver must always assume full responsibility for driving safely by paying careful attention to the surrounding conditions and operating the steering wheel to correct the path of the vehicle. Also, the driver must take adequate breaks when fatigued, such as from driving for a long period of time.

● Failure to perform appropriate driving operations and pay careful attention may lead to an accident, resulting in death or serious injury.

● When not using the LTA system, use the LTA switch to turn the system off.

**■ Situations unsuitable for LTA system**

In the following situations, use the LTA switch to turn the system off. Failure to do so may lead to an accident, resulting in death or serious injury.

● Vehicle is driven on a road surface which is slippery due to rainy weather, fallen snow, freezing, etc.

● Vehicle is driven on a snow-covered road.

● White (yellow) lines are difficult to see due to rain, snow, fog, dust, etc.

● Vehicle is driven in a temporary lane or restricted lane due to construction work.

### WARNING

- Vehicle is driven in a construction zone.
  - A spare tire, tire chains, etc. are equipped.
  - When the tires have been excessively worn, or when the tire inflation pressure is low.
  - When tires of a size other than specified are installed.
  - Vehicle is driven in traffic lanes other than that highways and freeways.
  - When your vehicle is towing a trailer or during emergency towing
- **Preventing LTA system malfunctions and operations performed by mistake**
- Do not modify the headlights or place stickers, etc. on the surface of the lights.
  - Do not modify the suspension etc. If the suspension etc. needs to be replaced, contact your Toyota dealer.
  - Do not install or place anything on the hood or grille. Also, do not install a grille guard (bull bars, kangaroo bar, etc.).
  - If your windshield needs repairs, contact your Toyota dealer.

■ **Conditions in which functions may not operate properly**

In the following situations, the functions may not operate properly and the vehicle may depart from its lane. Drive safely by always paying careful attention to your surroundings and operate the steering wheel to correct the path of the vehicle without relying solely on the functions.

- When the follow-up cruising display is displayed (→P.242) and the preceding vehicle changes lanes. (Your vehicle may follow the preceding vehicle and also change lanes.)

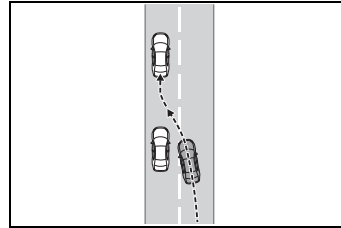

- When the follow-up cruising display is displayed (→P.242) and the preceding vehicle is swaying. (Your vehicle may sway accordingly and depart from the lane.)
- When the follow-up cruising display is displayed (→P.242) and the preceding vehicle departs from its lane. (Your vehicle may follow the preceding vehicle and depart from the lane.)
- When the follow-up cruising display is displayed (→P.242) and the preceding vehicle is being driven extremely close to the left/right lane line. (Your vehicle may follow the preceding vehicle and depart from the lane.)
- Vehicle is being driven around a sharp curve.

**! WARNING**

- Objects or patterns that could be mistaken for white (yellow) lines are present on the side of the road (guardrails, reflective poles, etc.).

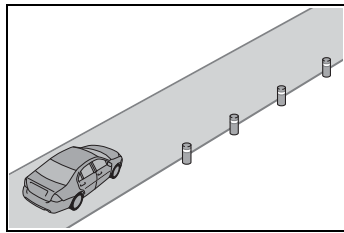

- Vehicle is driven where the road diverges, merges, etc.

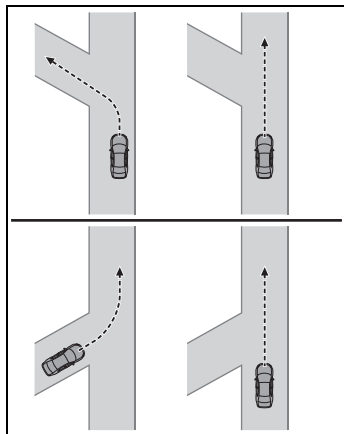

- Repair marks of asphalt, white (yellow) lines, etc. are present due to road repair.

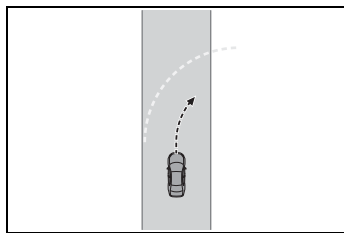

- There are shadows on the road that run parallel with, or cover, the white (yellow) lines.

- The vehicle is driven in an area without white (yellow) lines, such as in front of a tollgate or checkpoint, or at an intersection, etc.
- The white (yellow) lines are cracked, "Botts' dots", "Raised pavement marker" or stones are present.
- The white (yellow) lines cannot be seen or are difficult to see due to sand, etc.
- The vehicle is driven on a road surface that is wet due to rain, puddles, etc.
- The traffic lines are yellow (which may be more difficult to recognize than lines that are white).
- The white (yellow) lines cross over a curb, etc.
- The vehicle is driven on a bright surface, such as concrete.
- If the edge of the road is not clear or straight.
- The vehicle is driven on a surface that is bright due to reflected light, etc.
- The vehicle is driven in an area where the brightness changes suddenly, such as at the entrances and exits of tunnels, etc.
- Light from the headlights of an oncoming vehicle, the sun, etc. enters the camera.
- The vehicle is driven on a slope.
- The vehicle is driven on a road which tilts left or right, or a winding road.
- The vehicle is driven on an unpaved or rough road.

**⚠ WARNING**

- The traffic lane is excessively narrow or wide.
- The vehicle is extremely tilted due to carrying heavy luggage or having improper tire pressure.
- The distance to the preceding vehicle is extremely short.
- The vehicle is moving up and down a large amount due to road conditions during driving (poor roads or road seams).
- When driving in a tunnel or at night with the headlights off or when a headlight is dim due to its lens being dirty or it being misaligned.
- The vehicle is struck by a crosswind.
- The vehicle is affected by wind from a vehicle driven in a nearby lane.
- The vehicle has just changed lanes or crossed an intersection.
- Tires which differ by structure, manufacturer, brand or tread pattern are used.
- Snow tires, etc. are equipped.
- The vehicle is being driven at extremely high speeds.

**Functions included in LTA system**

■ **Lane departure alert function**

When the system determines that the vehicle might depart from its lane or course\*, a warn-

ing is displayed on the multi-information display, and a warning buzzer will sound to alert the driver.

When the warning buzzer sounds, check the area around your vehicle and carefully operate the steering wheel to move the vehicle back to the center of the lane.

Vehicles with Blind Spot Monitor: When the system determines that the vehicle might depart from its lane and that the possibility of a collision with an overtaking vehicle in the adjacent lane is high, the lane departure alert will operate even if the turn signals are operating.

\*: Boundary between asphalt and the side of the road, such as grass, soil, or a curb

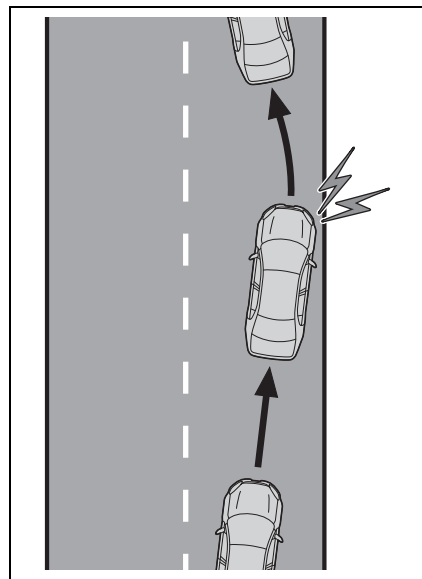

■ **Steering assist function**

When the system determines that the vehicle might depart from its lane or course\*, the sys-



tem provides assistance as necessary by operating the steering wheel in small amounts for a short period of time to keep the vehicle in its lane.

If the system detects that the steering wheel has not been operated for a fixed amount of time or the steering wheel is not being firmly gripped, a warning is displayed on the multi-information display and the function is temporarily canceled.

Vehicles with Blind Spot Monitor: When the system determines that the vehicle might depart from its lane and that the possibility of a collision with an overtaking vehicle in the adjacent lane is high, the steering assist function will operate even if the turn signals are operating.

\*: Boundary between asphalt and the side of the road, such as grass, soil, or a curb

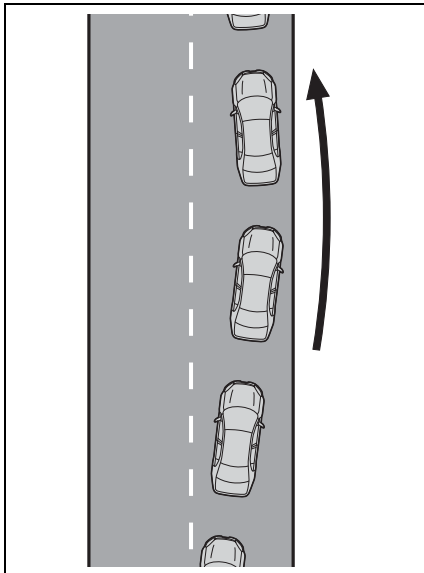

#### ■ Vehicle sway warning function

When the vehicle is swaying within a lane, the warning buzzer will sound and a message will be displayed on the multi-information display to alert the driver.

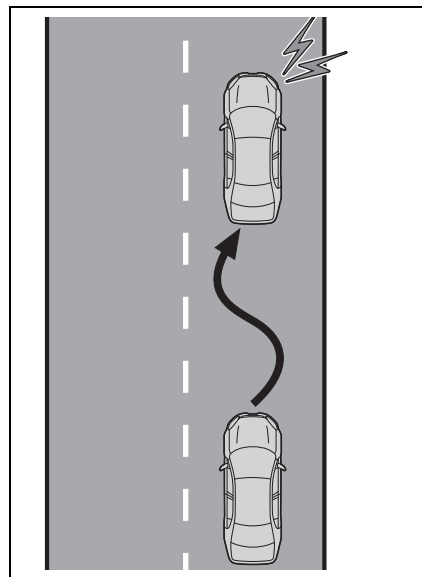

#### ■ Lane centering function

This function is linked with dynamic radar cruise control with full-speed range and provides the required assistance by operating the steering wheel to keep the vehicle in its current lane.

When dynamic radar cruise control with full-speed range is not operating, the lane centering function does not operate.

In situations where the white (yellow) lane lines are difficult to see or are not visible, such as when in a

traffic jam, this function will operate to help follow a preceding vehicle by monitoring the position of the preceding vehicle.

If the system detects that the steering wheel has not been operated for a fixed amount of time or the steering wheel is not being firmly gripped, a warning is displayed on the multi-information display and the function is temporarily canceled.

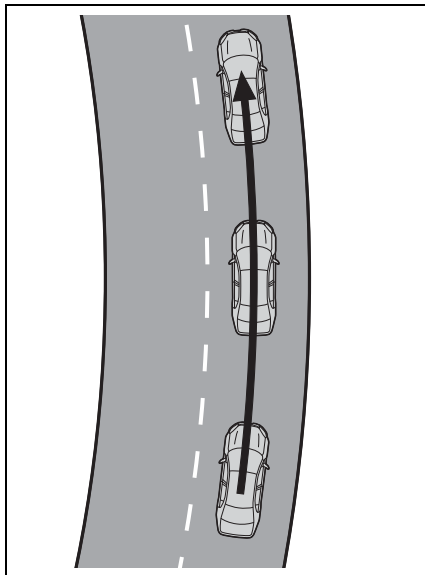

### Turning LTA system on

Press the LTA switch to turn the LTA system on.

The LTA indicator illuminates and a message is displayed on the multi-information display.

Press the LTA switch again to turn the LTA system off.

When the LTA system is turned on or off, operation of the LTA system continues in the same condition the

next time the engine is started.

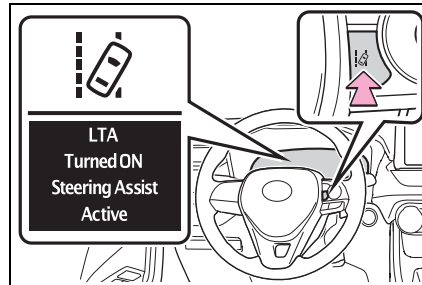

### Indications on multi-information display

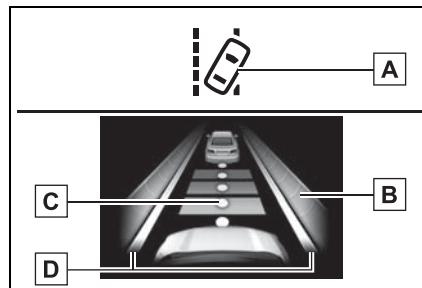

#### A | LTA indicator

The illumination condition of the indicator informs the driver of the system operation status.

Illuminated in white: LTA system is operating.

Illuminated in green: Steering wheel assistance of the steering assist function or lane centering function is operating.

Flashing in orange: Lane departure alert function is operating.

#### B | Operation display of steering wheel operation support

Displayed when the multi-information display is switched to the driving support system information display.

Indicates that steering wheel assis-

tance of the steering assist function or lane centering function is operating.

Both outer sides of the lane are displayed: Indicates that steering wheel assist of the lane centering function is operating.

One outer side of the lane is displayed: Indicates that steering wheel assist of the steering assist function is operating.

Both outer sides of the lane are flashing: Alerts the driver that their input is necessary to stay in the center of the lane (lane centering function).

**C** Follow-up cruising display

Displayed when the multi-information display is switched to the driving support system information display.

Indicates that steering assist of the lane centering function is operating by monitoring the position of a preceding vehicle.

When the follow-up cruising display is displayed, if the preceding vehicle moves, your vehicle may move in the same way. Always pay careful attention to your surroundings and operate the steering wheel as necessary to correct the path of the vehicle and ensure safety.

**D** Lane departure alert function display

Displayed when the multi-information display is switched to the driving support system information display.

▶ Inside of displayed lines is white



Indicates that the system is recognizing white (yellow) lines or a course\*. When the vehicle departs from its lane, the white line displayed on the side the vehicle departs from flashes orange.

▶ Inside of displayed lines is black

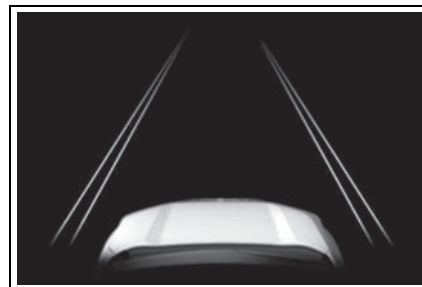

Indicates that the system is not able to recognize white (yellow) lines or a course\* or is temporarily canceled.

\*: Boundary between asphalt and the side of the road, such as grass, soil, or a curb

**■ Operation conditions of each function**

- Lane departure alert function

This function operates when all of the following conditions are met.

- LTA is turned on.
- Vehicle speed is approximately 32 mph (50 km/h) or more.\*<sup>1</sup>
- System recognizes white (yellow) lane lines or a course\*<sup>2</sup>. (When a white [yellow] line or course\*<sup>2</sup> is recognized on only one side, the system will operate only for the recognized side.)
- Width of traffic lane is approximately 9.8 ft. (3 m) or more.
- Turn signal lever is not operated. (Vehicles with Blind Spot Monitor: Except when another vehicle is in the lane on the side where the turn signal was operated)
- Vehicle is not being driven around a sharp curve.
- No system malfunctions are detected. (→P.246)

\*<sup>1</sup>: The function operates even if the vehicle speed is less than approximately 32 mph (50 km/h) when the lane centering function is operating.

\*<sup>2</sup>: Boundary between asphalt and the side of the road, such as grass, soil, or a curb

#### ● Steering assist function

This function operates when all of the following conditions are met in addition to the operation conditions for the lane departure alert function.

- Setting for “Steering Assist” in the  screen of the multi-information display is set to “ON”. (→P.89)
- Vehicle is not accelerated or decelerated by a fixed amount or more.
- Steering wheel is not operated with a steering force level suitable for changing lanes.
- ABS, VSC, TRAC and PCS are not operating.
- TRAC or VSC is not turned off.
- Hands off steering wheel warning is not displayed. (→P.245)

#### ● Vehicle sway warning function

This function operates when all of the following conditions are met.

- Setting for “Sway Warning” in the  screen of the multi-information display is set to “ON”. (→P.89)
- Vehicle speed is approximately 32 mph (50 km/h) or more.
- Width of traffic lane is approximately 9.8 ft. (3 m) or more.
- No system malfunctions are detected. (→P.246)

#### ● Lane centering function

This function operates when all of the following conditions are met.

- LTA is turned on.
- Setting for “Steering Assist” and “Lane Center” in the  screen of the multi-information display are set to “ON”. (→P.89)
- This function recognizes white (yellow) lane lines or the position of a preceding vehicle (except when the preceding vehicle is small, such as a motorcycle).
- The dynamic radar cruise control with full-speed range is operating in vehicle-to-vehicle distance control mode.
- Width of traffic lane is approximately 10 to 13 ft. (3 to 4 m).
- Turn signal lever is not operated.
- Vehicle is not being driven around a sharp curve.
- No system malfunctions are detected. (→P.246)
- Vehicle does not accelerate or decelerate by a fixed amount or more.
- Steering wheel is not operated with a steering force level suitable for changing lanes.
- ABS, VSC, TRAC and PCS are not operating.
- TRAC or VSC is not turned off.
- Hands off steering wheel warning is not displayed. (→P.245)
- The vehicle is being driven in the center of a lane.
- Steering assist function is not operating.

■ **Temporary cancelation of functions**

- When operation conditions are no longer met, a function may be temporarily canceled. However, when the operation conditions are met again, operation of the function is automatically restored. (→P.243)
- If the operation conditions (→P.243) are no longer met while the lane centering function is operating, the buzzer may sound to indicate that the function has been temporarily canceled.

■ **Steering assist function/lane centering function**

- Depending on the vehicle speed, lane departure situation, road conditions, etc., the driver may not feel the function is operating or the function may not operate at all.
- The steering control of the function is overridden by the driver's steering wheel operation.
- Do not attempt to test the operation of the steering assist function.

■ **Lane departure alert function**

- The warning buzzer may be difficult to hear due to external noise, audio playback, etc.
- If the edge of the course\* is not clear or straight, the lane departure alert function may not operate.
- Vehicles with Blind Spot Monitor: It may not be possible for the system to determine if there is a danger of a collision with a vehicle in an adjacent lane.
- Do not attempt to test the operation of the lane departure alert function.

\*: Boundary between asphalt and the side of the road, such as grass, soil, or a curb

■ **Hands off steering wheel warning**

In the following situations, a warning message urging the driver to hold the steering wheel and the symbol shown in the illustration are displayed on the multi-information display to warn the driver. The warning stops when the system determines that the driver holds the steering wheel. Always keep your hands on the steering wheel when using this system, regardless of warnings.

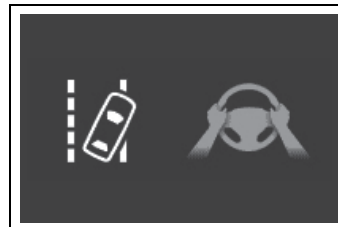

- When the system determines that the driver is driving without holding the steering wheel while the system is operating

If the driver continues to keep their hands off of the steering wheel, the buzzer sounds, the driver is warned and the function is temporarily canceled. This warning also operates in the same way when the driver continuously operates the steering wheel only a small amount.

- When the system determines that the vehicle may not turn and instead depart from its lane while driving around a curve

Depending on the vehicle condition and road conditions, the warning may not operate. Also, if the system determines that the vehicle is driving around a curve, warnings will occur earlier than during straight-lane driving.

- When the system determines that the driver is driving without holding the steering wheel while the

steering wheel assist of the steering assist function is operating.

If the driver continues to keep their hands off of the steering wheel and the steering wheel assist is operating, the buzzer sounds and the driver is warned. Each time the buzzer sounds, the continuing time of the buzzer becomes longer.

#### ■ Vehicle sway warning function

When the system determines that the vehicle is swaying while the vehicle sway warning function is operating, a buzzer sounds and a warning message urging the driver to rest and the symbol shown in the illustration are simultaneously displayed on the multi-information display.



Depending on the vehicle and road conditions, the warning may not operate.

#### ■ Warning message

If the following warning message is displayed on the multi-information display and the LTA indicator illuminates in orange, follow the appropriate troubleshooting procedure. Also, if a different warning message is displayed, follow the instructions displayed on the screen.

- “LTA Malfunction Visit Your Dealer”

The system may not be operating properly. Have the vehicle inspected by your Toyota dealer.

- “LTA Unavailable”

The system is temporarily canceled

due to a malfunction in a sensor other than the front camera. Turn the LTA system off, wait for a little while, and then turn the LTA system back on.

- “LTA Unavailable at Current Speed”

The function cannot be used as the vehicle speed exceeds the LTA operation range. Drive slower.

#### ■ Customization

Function settings can be changed. (→P.94)

**RSA (Road Sign Assist)\***

\*: If equipped

**The RSA system recognizes specific road signs using the front camera and/or navigation system (when speed limit information is available) to provide information to the driver via the display.**

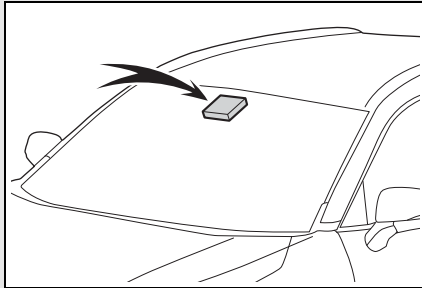

**If the system judges that the vehicle is being driven over the speed limit, performing prohibited actions, etc. in relation to the recognized road signs, it notifies the driver using a notification display and notification buzzer.**

**⚠ WARNING**

**■ Before using the RSA**

Do not rely solely upon the RSA system. RSA is a system which supports the driver by providing information, but it is not a replacement for a driver's own vision and awareness. Drive safely by always paying careful attention to the traffic rules.

**Indication on the multi-information display**

When the front camera recognizes a sign and/or information of a sign is available from the navigation system, the sign will be displayed on the multi-information display.

- When the driving support system information display is selected, a maximum of 3 signs can be displayed. (→P.89)

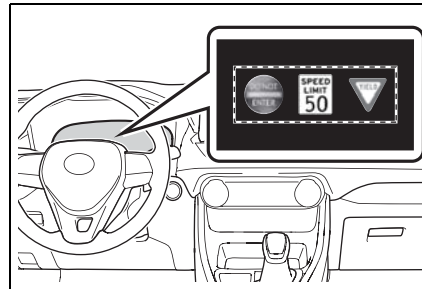

- When a tab other than the driving support system information display is selected, the following types of road signs will be displayed. (→P.89)
  - Speed limit sign
  - Do Not Enter sign (when notification is necessary)

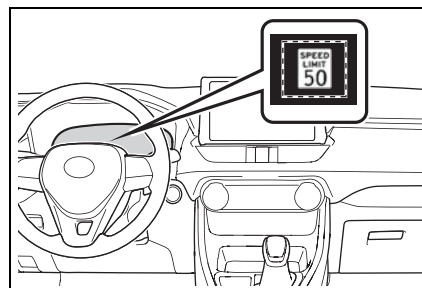

If signs other than speed limit signs are recognized, they will be displayed in an overlapping stack under the current speed limit sign.

### Supported types of road signs

The following types of road signs, including electronic signs and blinking signs, are recognized.

A non-official or a recently introduced traffic sign may not be recognized.



Speed limit



Do Not Enter



Stop



Yield

### Notification function

In the following situations, the RSA system will notify the driver.

- When the vehicle speed exceeds the speed notification threshold of the speed limit sign displayed, the sign display will be emphasized and a buzzer will sound.
  - When the RSA system recognizes a do not enter sign and determines that your vehicle has entered a no-entry area, the displayed sign will flash and a buzzer will sound.
- Depending on the situation, a notification function may not operate properly.
- 
- **Setting procedure**  
→P.94
- **Automatic turn-off of RSA sign display**
- In the following situations, displayed speed limit and do not enter signs will stop being displayed automatically:
- A new sign is not recognized for a certain distance.
  - The road changes due to a left or right turn, etc.
- In the following situations, stop and yield signs will stop being displayed automatically:
- The system determines that your vehicle has passed the sign.
  - The road changes due to a left or right turn, etc.
- **Conditions in which the function may not operate or detect correctly**
- In the following situations, RSA does not operate normally and may not recognize signs, display the incorrect sign, etc. However, this does not indicate a malfunction.
- The front camera is misaligned due to a strong impact being applied to the sensor, etc.
  - Dirt, snow, stickers, etc. are on the windshield near the front camera.
  - In inclement weather such as



- heavy rain, fog, snow or sand storms
- Light from an oncoming vehicle, the sun, etc. enters the front camera.
- The sign is dirty, faded, tilted or bent, and if an electronic sign, the contrast is poor.
- All or part of the sign is hidden by the leaves of a tree, a pole, etc.
- The sign is only visible to the front camera for a short amount of time.
- The driving scene (turning, lane change, etc.) is judged incorrectly.
- Even if it is a sign not appropriate for the currently traveled lane, such a sign exists directly after a freeway branches, or in an adjacent lane just before merging.
- Stickers are attached to the rear of the preceding vehicle.
- A sign resembling a system compatible sign is recognized.
- Side road speed signs may be detected and displayed (if positioned in sight of the front camera) while the vehicle is traveling on the main road.
- Roundabout exit road speed signs may be detected and displayed (if positioned in sight of the front camera) while traveling on a roundabout.
- The front of the vehicle is raised or lowered due to the carried load.
- The surrounding brightness is not sufficient or changes suddenly.
- When a sign intended for trucks, etc. is recognized.
- The speed information displayed on the meter and that displayed on the navigation system may be different due to the navigation system using map data.

■ **Speed limit sign display**

If the engine switch was last turned off while a speed limit sign was dis-

played on the multi-information display, the same sign displays again when the engine switch is turned to ON.

■ **If “RSA Malfunction Visit Your Dealer” is shown**

The system may be malfunctioning. Have the vehicle inspected by your Toyota dealer.

■ **Customization**

Some functions can be customized. (Customizable features: →P.94)

Dynamic radar cruise control with full-speed range

In vehicle-to-vehicle distance control mode, the vehicle automatically accelerates, decelerates and stops to match the speed changes of the preceding vehicle even if the accelerator pedal is not depressed. In constant speed control mode, the vehicle runs at a fixed speed.

Use the dynamic radar cruise control with full-speed range on freeways and highways.

- Vehicle-to-vehicle distance control mode (→P.253)
- Constant speed control mode (→P.257)

System Components

■ Meter display

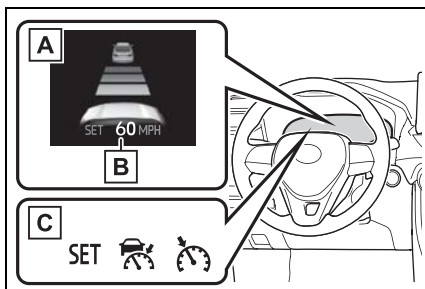

- A Multi-information display
- B Set speed

C Indicators

■ Operation switches

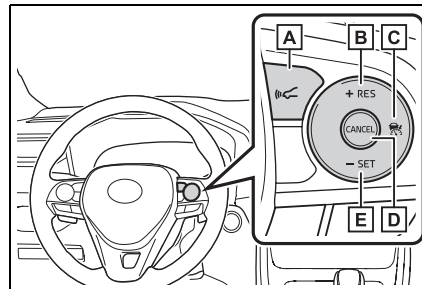

- A Vehicle-to-vehicle distance switch
- B "+RES" switch
- C Cruise control main switch
- D Cancel switch
- E "-SET" switch

**WARNING**

■ Before using dynamic radar cruise control with full-speed range

- Driving safely is the sole responsibility of the driver. Do not rely solely on the system, and drive safely by always paying careful attention to your surroundings.

**⚠ WARNING**

- The dynamic radar cruise control with full-speed range provides driving assistance to reduce the driver's burden. However, there are limitations to the assistance provided.

Read the following conditions carefully. Do not overly rely on this system and always drive carefully.

- When the sensor may not be correctly detecting the vehicle ahead: →P.259
- Conditions under which the vehicle-to-vehicle distance control mode may not function correctly: →P.259
- Set the speed appropriately depending on the speed limit, traffic flow, road conditions, weather conditions, etc. The driver is responsible for checking the set speed.
- Even when the system is functioning normally, the condition of the preceding vehicle as detected by the system may differ from the condition observed by the driver. Therefore, the driver must always remain alert, assess the danger of each situation and drive safely. Relying solely on this system or assuming the system ensures safety while driving can lead to an accident, resulting in death or serious injury.
- Switch the dynamic radar cruise control with full-speed range setting to off, using the cruise control main switch when not in use.

**■ Cautions regarding the driving assist systems**

Observe the following precautions, as there are limitations to the assistance provided by the system. Failure to do so may cause an accident resulting in death or serious injury.

- Assisting the driver to measure following distance

The dynamic radar cruise control with full-speed range is only intended to help the driver in determining the following distance between the driver's own vehicle and a designated vehicle traveling ahead. It is not a mechanism that allows careless or inattentive driving, and it is not a system that can assist the driver in low-visibility conditions.

It is still necessary for driver to pay close attention to the vehicle's surroundings.

- Assisting the driver to judge proper following distance

The dynamic radar cruise control with full-speed range determines whether the following distance between the driver's own vehicle and a designated vehicle traveling ahead is within a set range. It is not capable of making any other type of judgement. Therefore, it is absolutely necessary for the driver to remain vigilant and to determine whether or not there is a possibility of danger in any given situation.

 **WARNING**

- Assisting the driver to operate the vehicle

The dynamic radar cruise control with full-speed range does not include functions which will prevent or avoid collisions with vehicles ahead of your vehicle.

Therefore, if there is ever any possibility of danger, the driver must take immediate and direct control of the vehicle and act appropriately in order to ensure the safety of all involved.

- **Situations unsuitable for dynamic radar cruise control with full-speed range**

Do not use dynamic radar cruise control with full-speed range in any of the following situations. Doing so may result in inappropriate speed control and could cause an accident resulting in death or serious injury.

- Roads where there are pedestrians, cyclists, etc.
- In heavy traffic
- On roads with sharp bends
- On winding roads
- On slippery roads, such as those covered with rain, ice or snow
- On steep downhill, or where there are sudden changes between sharp up and down gradients

Vehicle speed may exceed the set speed when driving down a steep hill.

- At entrances to freeways and highways

- When weather conditions are bad enough that they may prevent the sensors from detecting correctly (fog, snow, sandstorm, heavy rain, etc.)
- When there is rain, snow, etc. on the front surface of the radar or front camera
- In traffic conditions that require frequent repeated acceleration and deceleration
- When your vehicle is towing a trailer or during emergency towing
- When an approach warning buzzer is heard often

### Driving in vehicle-to-vehicle distance control mode

This mode employs a radar to detect the presence of vehicles up to approximately 328 ft. (100 m) ahead, determines the current vehicle-to-vehicle following distance, and operates to maintain a suitable following distance from the vehicle ahead. The desired vehicle-to-vehicle distance can also be set by operating the vehicle-to-vehicle distance switch.

When driving on downhill slopes, the vehicle-to-vehicle distance may become shorter.

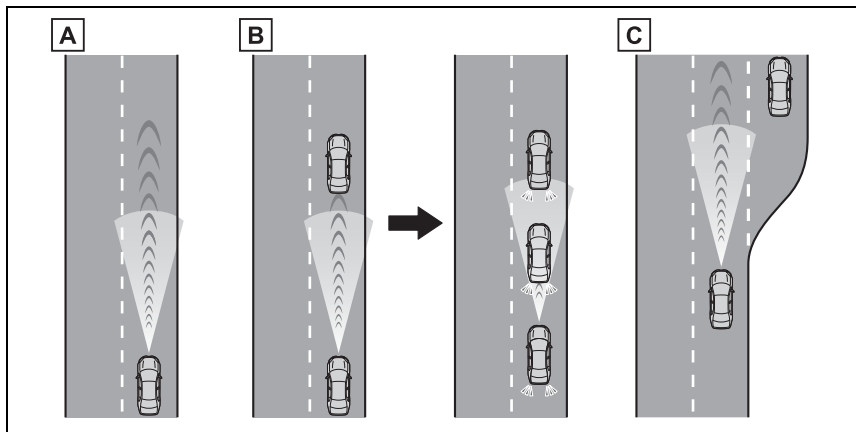

#### A Example of constant speed cruising

When there are no vehicles ahead

The vehicle travels at the speed set by the driver.

#### B Example of deceleration cruising and follow-up cruising

When a preceding vehicle driving slower than the set speed appears

When a vehicle is detected running ahead of you, the system automatically decelerates your vehicle. When a greater reduction in vehicle speed is necessary, the system applies the brakes (the stop lights will come on at this time). The system will respond to changes in the speed of the vehicle ahead in order to maintain the vehicle-to-vehicle distance set by the driver. Approach warning warns you when the system cannot decelerate sufficiently to prevent your vehicle from closing in on the vehicle ahead.

When the vehicle ahead of you stops, your vehicle will also stop (vehicle is stopped by system control). After the vehicle ahead starts off, pressing the "+RES" switch or depressing the accelerator pedal (start-off operation) will resume follow-up cruising. If the start-off operation is not performed, system

control continues to keep your vehicle stopped.

When the turn signal lever is operated and your vehicle moves to a left lane while driving at 50 mph (80 km/h) or more, the vehicle will quickly accelerate to help to overtake a passing vehicle.

**C** Example of acceleration

When there are no longer any preceding vehicles driving slower than the set speed

The system accelerates until the set speed is reached. The system then returns to constant speed cruising.

**Setting the vehicle speed (vehicle-to-vehicle distance control mode)**

- 1 Press the cruise control main switch to activate the cruise control.

Dynamic radar cruise control indicator will come on and a message will be displayed on the multi-information display. Press the switch again to deactivate the cruise control.

If the cruise control main switch is pressed and held for 1.5 seconds or more, the system turns on in constant speed control mode. (→P.257)

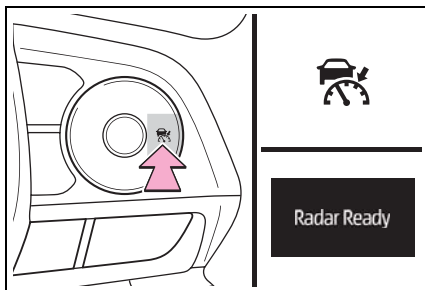

- 2 Accelerate or decelerate, with accelerator pedal operation, to the desired vehicle speed (at or above approximately 20 mph [30 km/h])

and press the “-SET” switch to set the speed.

Cruise control “SET” indicator will come on.

The vehicle speed at the moment the switch is released becomes the set speed.

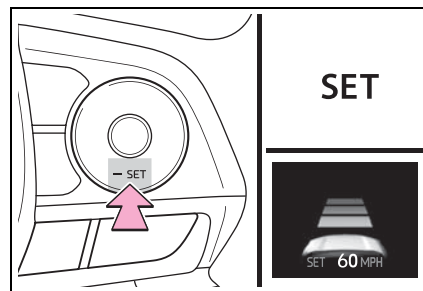

**Adjusting the set speed**

To change the set speed, press the “+RES” or “-SET” switch until the desired set speed is displayed.

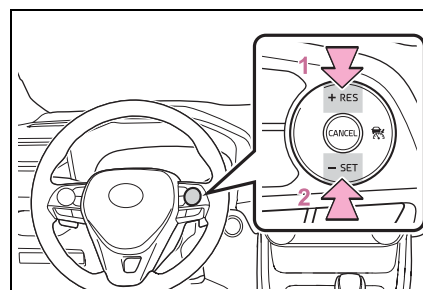

1 Increases the speed (Except when the vehicle has been stopped by system control in vehicle-to-vehicle distance control mode)

2 Decreases the speed  
 Fine adjustment: Press the switch.  
 Large adjustment: Press and hold the switch to change the speed, and release when the desired speed is reached.

In the vehicle-to-vehicle distance control mode, the set speed will be increased or decreased as follows:

- ▶ For the U.S. mainland and Hawaii

Fine adjustment: By 1 mph (1.6 km/h)<sup>\*1</sup> or 1 km/h (0.6 mph)<sup>\*2</sup> each time the switch is pressed

Large adjustment: Increases or decreases in 1 mph (1.6 km/h)<sup>\*1</sup> or 1 km/h (0.6 mph)<sup>\*2</sup> increments for as long as the switch is held

- ▶ Except for the U.S. mainland and Hawaii

Fine adjustment: By 1 mph (1.6 km/h)<sup>\*1</sup> or 1 km/h (0.6 mph)<sup>\*2</sup> each time the switch is pressed

Large adjustment: Increases or decreases in 5 mph (8 km/h)<sup>\*1</sup> or 5 km/h (3.1 mph)<sup>\*2</sup> increments for as long as the switch is held

In the constant speed control mode (→P.257), the set speed will be increased or decreased as follows:

Fine adjustment: By 1 mph (1.6

km/h)<sup>\*1</sup> or 1 km/h (0.6 mph)<sup>\*2</sup> each time the switch is pressed

Large adjustment: The speed will continue to change while the switch is held.

\*1: When the set speed is shown in "MPH"

\*2: When the set speed is shown in "km/h"

**Changing the vehicle-to-vehicle distance (vehicle-to-vehicle distance control mode)**

Pressing the switch changes the vehicle-to-vehicle distance as follows:

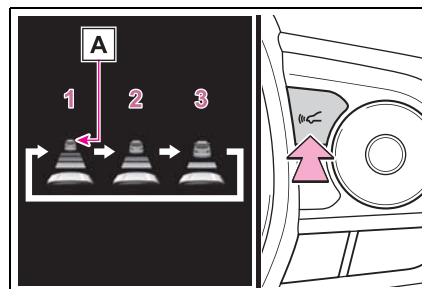

- 1 Long
- 2 Medium
- 3 Short

The vehicle-to-vehicle distance is set automatically to long mode when the engine switch is turned to ON.

If a vehicle is running ahead of you, the preceding vehicle mark **A** will also be displayed.

**Vehicle-to-vehicle distance settings (vehicle-to-vehicle distance control mode)**

Select a distance from the table below. Note that the distances shown correspond to a vehicle speed of 50 mph (80 km/h). Vehicle-to-vehicle distance increases/decreases in accordance with vehicle speed. When the vehicle is stopped by system control, the vehicle stops at a certain vehicle-to-vehicle distance depending on the situation.

Distance options	Vehicle-to-vehicle distance
Long	Approximately 160 ft. (50 m)
Medium	Approximately 130 ft. (40 m)
Short	Approximately 100 ft. (30 m)

**Resuming follow-up cruising when the vehicle has been stopped by system control (vehicle-to-vehicle distance control mode)**

After the vehicle ahead of you starts off, press the “+RES” switch.

Your vehicle will also resume follow-up cruising if the acceler-

ator pedal is depressed after the vehicle ahead of you starts off.

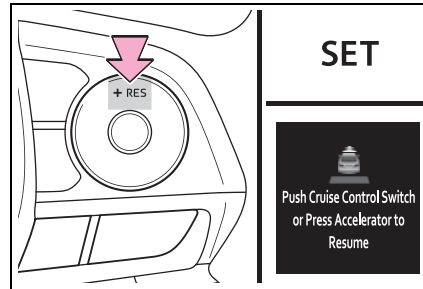

**Canceling and resuming the speed control**

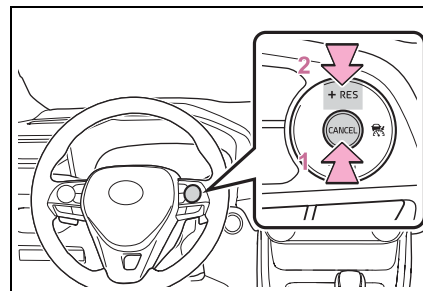

1 Pressing the cancel switch cancels the speed control.

The speed control is also canceled when the brake pedal is depressed. (When the vehicle has been stopped by system control, depressing the brake pedal does not cancel the setting.)

2 Pressing the “+RES” switch resumes the cruise control and returns vehicle speed to the set speed.

**Approach warning (vehicle-to-vehicle distance control mode)**

When your vehicle is too close



to a vehicle ahead, and sufficient automatic deceleration via the cruise control is not possible, the display will flash and the buzzer will sound to alert the driver. An example of this would be if another driver cuts in front of you while you are following a vehicle. Depress the brake pedal to ensure an appropriate vehicle-to-vehicle distance.

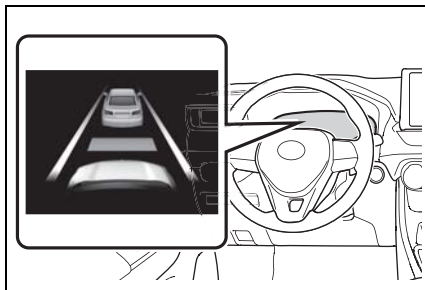

■ **Warnings may not occur when**

In the following instances, warnings may not occur even when the vehicle-to-vehicle distance is small.

- When the speed of the preceding vehicle matches or exceeds your vehicle speed
- When the preceding vehicle is traveling at an extremely slow speed
- Immediately after the cruise control speed was set
- When depressing the accelerator pedal

**Selecting constant speed control mode**

When constant speed control mode is selected, your vehicle will maintain a set speed without controlling the vehicle-to-vehicle distance. Select this mode only when vehicle-to-vehicle distance control mode does not function correctly due to a dirty radar, etc.

- 1 With the cruise control off, press and hold the cruise control main switch for 1.5 seconds or more.

Immediately after the switch is pressed, the dynamic radar cruise control indicator will come on. Afterwards, it switches to the cruise control indicator.

Switching to constant speed control mode is only possible when operating the switch with the cruise control off.

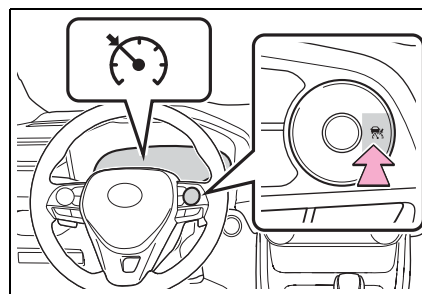

- 2 Accelerate or decelerate, with accelerator pedal operation, to the desired vehicle speed (at or above approximately 20 mph [30 km/h]) and press the “-SET” switch to set the speed.

Cruise control “SET” indicator will

come on.

The vehicle speed at the moment the switch is released becomes the set speed.

Adjusting the speed setting:  
→P.254

Canceling and resuming the speed setting: →P.256

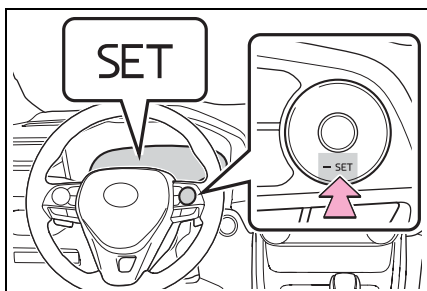

#### ■ Dynamic radar cruise control with full-speed range can be set when

- The shift lever is in D.
- The desired set speed can be set when the vehicle speed is approximately 20 mph (30 km/h) or more. (However, when the vehicle speed is set while driving at below approximately 20 mph [30 km/h], the set speed will be set to approximately 20 mph [30 km/h].)

#### ■ Accelerating after setting the vehicle speed

The vehicle can accelerate by operating the accelerator pedal. After accelerating, the set speed resumes. However, during vehicle-to-vehicle distance control mode, the vehicle speed may decrease below the set speed in order to maintain the distance to the preceding vehicle.

#### ■ When the vehicle stops while follow-up cruising

- Pressing the “+RES” switch while the vehicle ahead stops will resume follow-up cruising if the vehicle ahead starts off within

approximately 3 seconds after the switch is pressed.

- If the vehicle ahead starts off within 3 seconds after your vehicle stops, follow-up cruising will be resumed.

#### ■ Automatic cancelation of vehicle-to-vehicle distance control mode

Vehicle-to-vehicle distance control mode is automatically canceled in the following situations.

- VSC is activated.
- TRAC is activated for a period of time.
- When the VSC or TRAC system is turned off.
- The sensor cannot detect correctly because it is covered in some way.
- Pre-collision braking is activated.
- The parking brake is operated.
- The vehicle is stopped by system control on a steep incline.
- The following are detected when the vehicle has been stopped by system control:
  - The driver is not wearing a seat belt.
  - The driver's door is opened.
  - The vehicle has been stopped for about 3 minutes

If vehicle-to-vehicle distance control mode is automatically canceled for any reasons other than the above, there may be a malfunction in the system. Contact your Toyota dealer.

#### ■ Automatic cancelation of constant speed control mode

Constant speed control mode is automatically canceled in the following situations:

- Actual vehicle speed is more than approximately 10 mph (16 km/h) below the set vehicle speed.
- Actual vehicle speed falls below

- approximately 20 mph (30 km/h).
  - VSC is activated.
  - TRAC is activated for a period of time.
  - When the VSC or TRAC system is turned off.
  - Pre-collision braking is activated.
- If constant speed control mode is automatically canceled for any reasons other than the above, there may be a malfunction in the system. Contact your Toyota dealer.

■ **Brake operation**

A brake operation sound may be heard and the brake pedal response may change, but these are not malfunctions.

■ **Warning messages and buzzers for dynamic radar cruise control with full-speed range**

Warning messages and buzzers are used to indicate a system malfunction or to inform the driver of the need for caution while driving. If a warning message is shown on the multi-information display, read the message and follow the instructions. (→P.227, 639)

■ **When the sensor may not be correctly detecting the vehicle ahead**

In the case of the following and depending on the conditions, operate the brake pedal when deceleration of the system is insufficient or operate the accelerator pedal when acceleration is required.

As the sensor may not be able to correctly detect these types of vehicles, the approach warning (→P.256) may not be activated.

- Vehicles that cut in suddenly
- Vehicles traveling at low speeds
- Vehicles that are not moving in the same lane
- Vehicles with small rear ends

(trailers with no load on board, etc.)

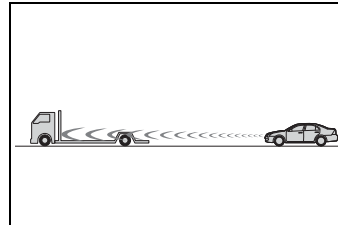

- Motorcycles traveling in the same lane
- When water or snow thrown up by the surrounding vehicles hinders the detecting of the sensor
- When your vehicle is pointing upwards (caused by a heavy load in the luggage compartment, etc.)

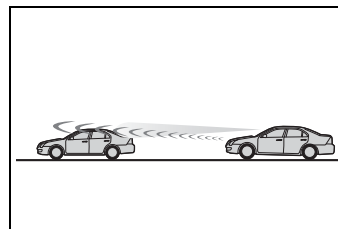

- Preceding vehicle has an extremely high ground clearance

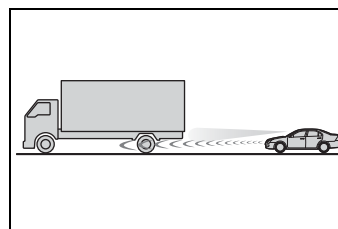

■ **Conditions under which the vehicle-to-vehicle distance control mode may not function correctly**

In the case of the following conditions, operate the brake pedal (or accelerator pedal, depending on the situation) as necessary.

As the sensor may not be able to correctly detect vehicles ahead, the system may not operate properly.

- When the road curves or when the lanes are narrow

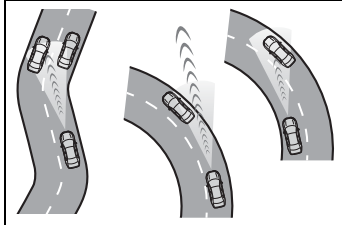

- When steering wheel operation or your position in the lane is unstable

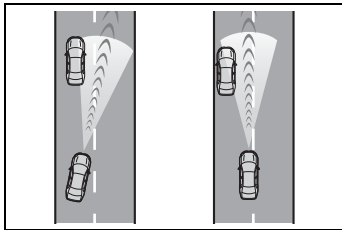

- When the vehicle ahead of you decelerates suddenly
- When driving on a road surrounded by a structure, such as in a tunnel or on a bridge
- While the vehicle speed is decreasing to the set speed after the vehicle accelerates by depressing the accelerator pedal

**BSM (Blind Spot Monitor)\***

\*: If equipped

**The Blind Spot Monitor is a system that has 2 functions:**

- The BSM (Blind Spot Monitor) function

Assists the driver in making a decision when changing lanes

- The RCTA (Rear Cross Traffic Alert) function

Assists the driver when backing up

**These functions use the same sensors.**

**⚠ WARNING**

**■ Cautions regarding the use of the BSM function**

The driver is solely responsible for safe driving. Always drive safely, taking care to observe your surroundings.

The BSM function is a supplementary function which alerts the driver that a vehicle is in a blind spot of the outside rear view mirrors or is approaching rapidly from behind into a blind spot. Do not overly rely on the BSM function. As the function cannot judge if it is safe to change lanes, over reliance could lead to an accident resulting in death or serious injury.

As the system may not function correctly under certain conditions, the driver's own visual confirmation of safety is necessary.

**⚠ WARNING**

**■ Cautions regarding the use of the RCTA function**

The driver is solely responsible for safe driving. Always drive safely, taking care to observe your surroundings.

The RCTA function is only a supplementary function which alerts the driver that a vehicle is approaching from the right or left at the rear of the vehicle. As the RCTA function may not function correctly under certain conditions, the driver's own visual confirmation of safety is necessary.

Over reliance on this function may lead to an accident resulting death or serious injury.

**System components**

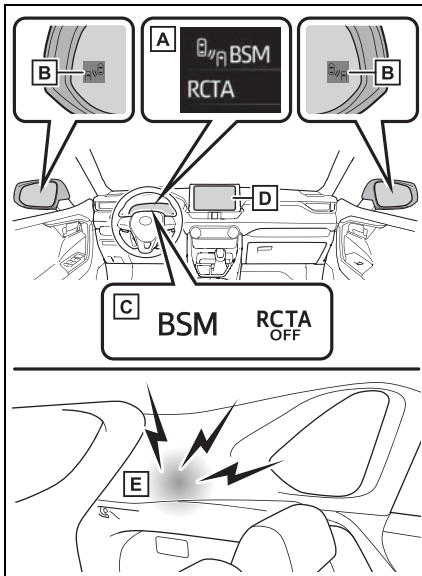

**A Multi-information display**

Turning the BSM function/RCTA function on/off.

**B Outside rear view mirror indi-**

cators

**BSM function:**

When a vehicle is detected in a blind spot of the outside rear view mirrors or approaching rapidly from behind into a blind spot, the outside rear view mirror indicator on the detected side will illuminate. If the turn signal lever is operated toward the detected side, the outside rear view mirror indicator will flash.

**RCTA function:**

When a vehicle approaching from the right or left at the rear of the vehicle is detected, both outside rear view mirror indicators will flash.

**C BSM indicator/RCTA OFF indicator**

When the Blind Spot Monitor is enabled, the BSM indicator illuminates.

When the RCTA function is disabled, the RCTA OFF indicator illuminates.

**D Monitor screen display (RCTA function only)**

If a vehicle approaching from the right or left at the rear of the vehicle is detected, the RCTA icon (→P.267) for the detected side will be displayed.

**E RCTA buzzer (RCTA function only)**

If a vehicle approaching from the right or left at the rear of the vehicle is detected, a buzzer will sound from behind the rear seat.

### Turning the BSM function/RCTA function on/off

The BSM function and the RCTA function can be enabled/disabled on the  screen of the multi-information display. (→P.94)

#### ■ Outside rear view mirror indicators visibility

In strong sunlight, the outside rear view mirror indicator may be difficult to see.

#### ■ Hearing the RCTA buzzer

The RCTA buzzer may be difficult to hear over loud noises such as high audio volume.

#### ■ When “Blind Spot Monitor Unavailable” or “Rear Cross Traffic Alert Unavailable” is shown on the multi-information display

The sensor voltage has become

#### ■ Certification for the Blind Spot Monitor

- ▶ For vehicles sold in the U.S.A., Hawaii, American Samoa, Guam, Saipan and Puerto Rico

FCC ID: HYQDNSRR004

#### NOTE:

This device complies with part 15 of the FCC Rules. Operation is subject to the following two conditions: (1) This device may not cause harmful interference, and (2) this device must accept any interference received, including interference that may cause undesired operation.

#### FCC WARNING:

Changes or modifications not expressly approved by the party responsible for compliance could void the user's authority to operate the equipment.

abnormal, or water, snow, mud, etc., may be built up in the vicinity of the sensor area of the rear bumper.

(→P.263)

Removing the water, snow, mud, etc., from the vicinity of the sensor area should return it to normal.

Also, the sensor may not function normally when used in extremely hot or cold weather.

#### ■ When “Blind Spot Monitor System Malfunction Visit Your Dealer” or “Rear Cross Traffic Alert Malfunction Visit Your Dealer” is shown on the multi-information display

There may be a sensor malfunction or misaligned. Have the vehicle inspected at a Toyota dealer.

#### ■ Customization

Some functions can be customized. (→P.94)

► For vehicles sold in Canada

**NOTE:**

This device complies with Industry Canada's RSS-310. Operation is subject to the condition that this device must not cause harmful interference and must accept any interference, including interference that may cause undesired operation of the device.

24.05 to 24.25 GHz  
250 mV/m or less @ 3m

**NOTE:**

Le CNR-310 doit être utilisé conjointement avec le CNR-Gen, Exigences générales relatives à la conformité des appareils de radiocommunication, concernant spécifications et informations d'ordre général.

24.05 to 24.25 GHz  
250 mV/m or less @ 3m

**⚠ WARNING**

■ **Handling the radar sensor**

Blind Spot Monitor sensors are installed inside the left and right sides of the rear bumper respectively. Observe the following to ensure the Blind Spot Monitor can function correctly.

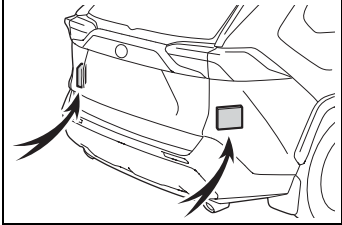

- Keep the sensors and the surrounding areas on the rear bumper clean at all times. If a sensor or its surrounding area on the rear bumper is dirty or covered with snow, the Blind Spot Monitor may not operate and a warning message (→P.262) will be displayed. In this situation, clear off the dirt or snow and drive the vehicle with the operation conditions of the BSM function (→P.265) satisfied for approximately 10 minutes. If the warning message does not disappear, have the vehicle inspected by your Toyota dealer.
- Do not subject a sensor or its surrounding area on the rear bumper to a strong impact. If a sensor is moved even slightly off position, the system may malfunction and vehicles may not be detected correctly. In the following situations, have your vehicle inspected by your Toyota dealer.
  - A sensor or its surrounding area is subject to a strong impact.

**⚠ WARNING**

- If the surrounding area of a sensor is scratched or dented, or part of them has become disconnected.
- Do not disassemble the sensor.
- Do not attach accessories, stickers (including transparent stickers), aluminum tape, etc. to a sensor or its surrounding area on the rear bumper.
- Do not modify the sensor or surrounding area on the rear bumper.
- If a sensor or the rear bumper needs to be removed/installed or replaced, contact your Toyota dealer.
- Do not paint the rear bumper any color other than an official Toyota color.

**The Blind Spot Monitor function****■ Vehicles that can be detected by the Blind Spot Monitor**

The BSM function uses radar sensors to detect the following vehicles traveling in adjacent lanes and advises the driver of the presence of such vehicles via the indicators on the outside rear view mirrors.

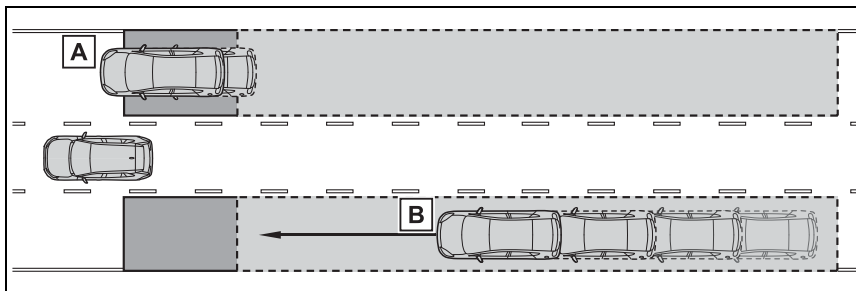

- A** Vehicles that are traveling in areas that are not visible using the outside rear view mirrors (the blind spots)
- B** Vehicles that are approaching rapidly from behind in areas that



are not visible using the outside rear view mirrors (the blind spots)

■ **The BSM function detection areas**

The areas that vehicles can be detected in are outlined below.

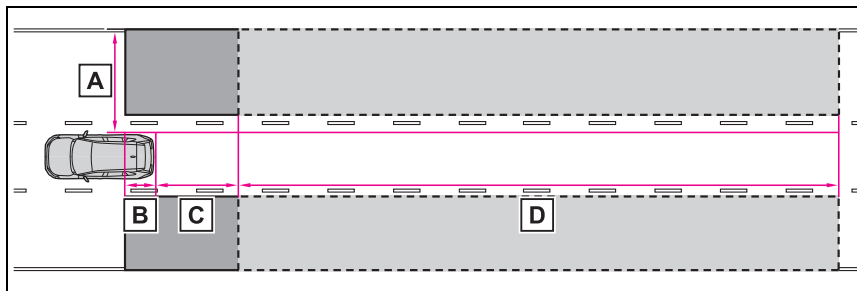

The range of each detection area is:

- **A** Approximately 1.6 ft. (0.5 m) to 11.5 ft. (3.5 m) from either side of the vehicle

The area between the side of the vehicle and 1.6 ft. (0.5 m) from the side of the vehicle cannot be detected.

- **B** Approximately 3.3 ft. (1 m) forward of the rear bumper

- **C** Approximately 9.8 ft. (3 m) from the rear bumper

- **D** Approximately 9.8 ft. (3 m) to 197 ft. (60 m) from the rear bumper

The greater the difference in speed between your vehicle and the detected vehicle is, the farther away the vehicle will be detected, causing the outside rear view mirror indicator to illuminate or flash.

■ **The BSM function is operational when**

The BSM function is operational when all of the following conditions are met:

- The BSM function is on.
- The shift lever is in a position other than R.
- The vehicle speed is greater than approximately 10 mph (16 km/h).

■ **The BSM function will detect a vehicle when**

The BSM function will detect a vehicle present in the detection area in the following situations:

- A vehicle in an adjacent lane over-

takes your vehicle.

- You overtake a vehicle in an adjacent lane slowly.
- Another vehicle enters the detection area when it changes lanes.

■ **Conditions under which the BSM function will not detect a vehicle**

The BSM function is not designed to detect the following types of vehicles and/or objects:

- Small motorcycles, bicycles, pedestrians, etc.\*
- Vehicles traveling in the opposite direction
- Guardrails, walls, signs, parked vehicles and similar stationary

objects \*

- Following vehicles that are in the same lane\*
- Vehicles traveling 2 lanes away from your vehicle\*
- Vehicles which are being overtaken rapidly by your vehicle

\*: Depending on the conditions, detection of a vehicle and/or object may occur.

#### ■ Conditions under which the BSM function may not function correctly

- The BSM function may not detect vehicles correctly in the following situations:
  - When the sensor is misaligned due to a strong impact to the sensor or its surrounding area
  - When mud, snow, ice, a sticker, etc. is covering the sensor or surrounding area on the rear bumper
  - When driving on a road surface that is wet with standing water during bad weather, such as heavy rain, snow, or fog
  - When multiple vehicles are approaching with only a small gap between each vehicle
  - When the distance between your vehicle and a following vehicle is short
  - When there is a significant difference in speed between your vehicle and the vehicle that enters the detection area
  - When the difference in speed between your vehicle and another vehicle is changing
  - When a vehicle enters a detection area traveling at about the same speed as your vehicle
  - As your vehicle starts from a stop, a vehicle remains in the detection area
  - When driving up and down consecutive steep inclines, such as hills, dips in the road, etc.
  - When driving on roads with sharp bends, consecutive curves, or

uneven surfaces

- When vehicle lanes are wide, or when driving on the edge of a lane, and the vehicle in an adjacent lane is far away from your vehicle
- When an accessory (such as a bicycle carrier) is installed to the rear of the vehicle
- When there is a significant difference in height between your vehicle and the vehicle that enters the detection area
- Immediately after the BSM function/RCTA function are turned on
- When towing a trailer
- Instances of the BSM function unnecessarily detecting a vehicle and/or object may increase in the following situations:
  - When the sensor is misaligned due to a strong impact to the sensor or its surrounding area
  - When the distance between your vehicle and a guardrail, wall, etc. that enters the detection area is short
  - When driving up and down consecutive steep inclines, such as hills, dips in the road, etc.
  - When vehicle lanes are narrow, or when driving on the edge of a lane, and a vehicle traveling in a lane other than the adjacent lanes enters the detection area
  - When driving on roads with sharp bends, consecutive curves, or uneven surfaces
  - When the tires are slipping or spinning
  - When the distance between your vehicle and a following vehicle is short
  - When an accessory (such as a bicycle carrier) is installed to the rear of the vehicle
  - When the vehicle throws up water or snow behind.

**The Rear Cross Traffic Alert function (if equipped)**

■ **Operation of the RCTA function**

The RCTA function uses radar sensors to detect vehicles approaching from the right or left at the rear of the vehicle and alerts the driver of the presence of such vehicles by flashing the outside rear view mirror indicators and sounding a buzzer.

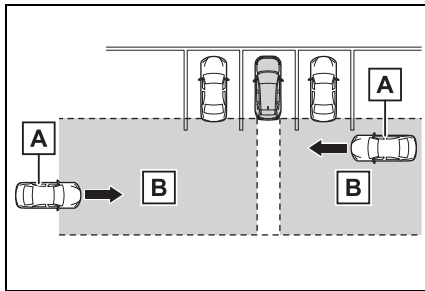

- A** Approaching vehicles
- B** Detection areas

■ **RCTA icon display (if equipped)**

When a vehicle approaching from the right or left at the rear of the vehicle is detected, the following will be displayed on the navigation system (if equipped) or multimedia system (if equipped) screen.

- When the Toyota parking assist monitor (if equipped) is displayed

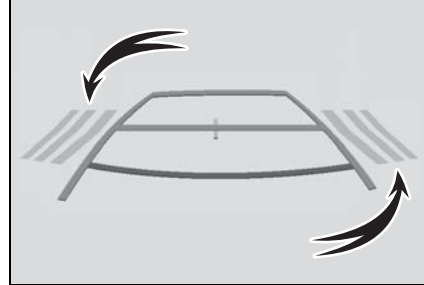

- When the panoramic view monitor (if equipped) is displayed

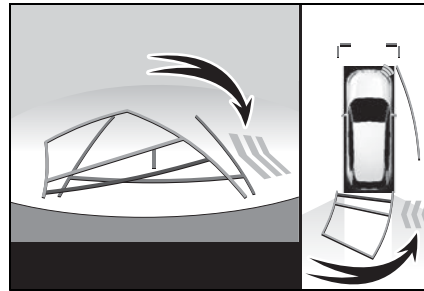

⊘: The RCTA function is malfunctioning (→P.262)

■ **The RCTA function detection areas**

The areas that vehicles can be detected in are outlined below.

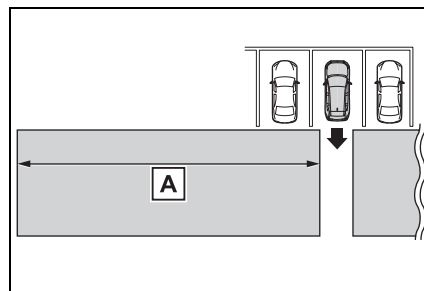

The buzzer can alert the driver of faster vehicles approaching from farther away.

Example:

Approaching vehicle	Speed	A Approximate alert distance
Fast	18 mph (28 km/h)	65 ft. (20 m)
Slow	5 mph (8 km/h)	18 ft. (5.5 m)

**■ The RCTA function is operational when**

The RCTA function operates when all of the following conditions are met:

- The RCTA function is on.
- The shift lever is in R.
- The vehicle speed is less than approximately 5 mph (8 km/h).
- The approaching vehicle speed is between approximately 5 mph (8 km/h) and 17 mph (28 km/h).

**■ Setting the buzzer volume**

The buzzer volume can be adjusted on the multi-information display. (→P.94)

**■ Conditions under which the RCTA function will not detect a vehicle**

The RCTA function is not designed to detect the following types of vehicles and/or objects.

- Vehicles approaching from directly behind
- Vehicles backing up in a parking space next to your vehicle
- Vehicles that the sensors cannot detect due to obstructions

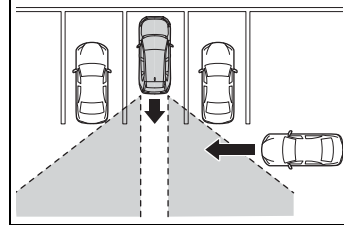

- Guardrails, walls, signs, parked vehicles and similar stationary objects\*
- Small motorcycles, bicycles, pedestrians, etc.\*
- Vehicles moving away from your vehicle
- Vehicles approaching from the parking spaces next to your vehicle\*

\*: Depending on conditions, detection of a vehicle and/or object may occur.

**■ Conditions under which the RCTA function may not function correctly**

- The RCTA function may not detect vehicles correctly in the following situations:
  - When the sensor is misaligned due to a strong impact to the sensor or its surrounding area
  - When mud, snow, ice, a sticker, etc. is covering the sensor or surrounding area on the rear bumper
  - When driving on a road surface that is wet with standing water during bad weather, such as heavy rain, snow, or fog
  - When multiple vehicles are approaching with only a small gap between each vehicle
  - When a vehicle is approaching at high speed
  - When parking on a steep incline, such as hills, a dip in the road, etc.
  - When an accessory (such as a bicycle carrier) is installed to the rear of the vehicle
  - When backing up on a slope with a sharp change in grade

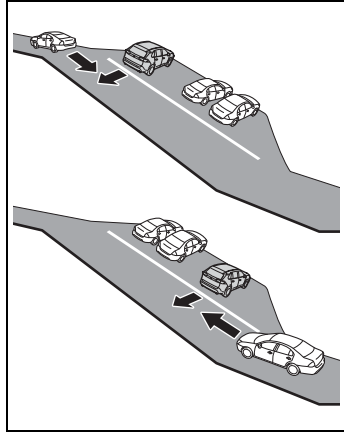

- When backing out of a shallow angle parking spot

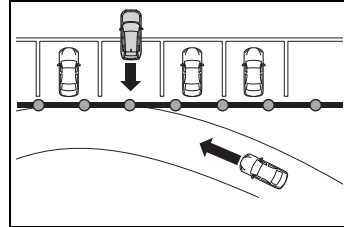

- When the distance between your vehicle and metal objects, such as a guardrail, wall, sign, or parked vehicle, which may reflect electrical waves toward the rear of the vehicle, is short
- When an accessory (such as a bicycle carrier) is installed to the rear of the vehicle

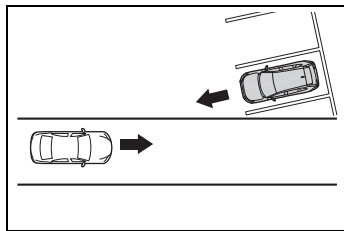

- Immediately after the RCTA function is turned on
- Immediately after the engine is started with the RCTA function on
- When towing a trailer
- When the sensors cannot detect a vehicle due to obstructions

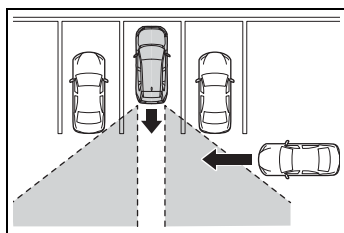

- Instances of the RCTA function unnecessarily detecting a vehicle and/or object may increase in the following situations:
  - When a vehicle passes by the side of your vehicle
  - When the parking space faces a street and vehicles are being driven on the street

### Intuitive parking assist\*

\*: If equipped

The distance from your vehicle to objects, such as a wall, when parallel parking or maneuvering into a garage is measured by the sensors and communicated via the multi-information display, navigation system or multimedia system screen and a buzzer. Always check the surrounding area when using this system.

is shown on the multi-information display depending on the position and distance to the object.

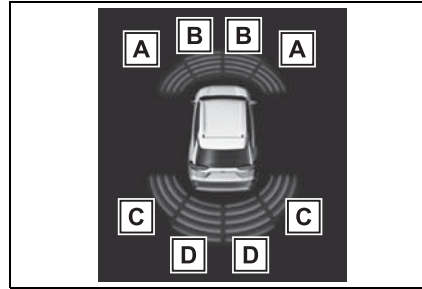

- A** Front corner sensor detection
- B** Front center sensor detection<sup>\*1</sup>
- C** Rear corner sensor detection<sup>\*2</sup>
- D** Rear center sensor detection<sup>\*2</sup>

<sup>\*1</sup>: Displayed when the shift lever is in a driving position

<sup>\*2</sup>: Displayed when the shift lever is in R

### System components

#### ■ Location and types of sensors

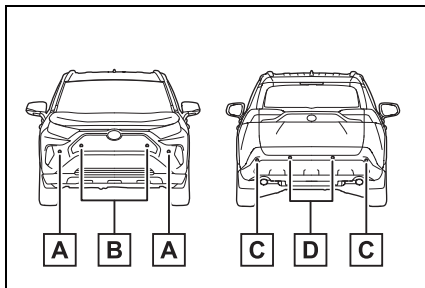

- A** Front corner sensors
- B** Front center sensors
- C** Rear corner sensors
- D** Rear center sensors

#### ■ Display (Multi-information display)

When the sensors detect an object, such as a wall, a graphic

#### ■ Display (Audio system screen)

When the sensors detect an object, such as a wall, a graphic is shown on the navigation system (if equipped) or multimedia system (if equipped) screen depending on the position and distance to the object.

- When the Toyota parking assist monitor (if equipped) is displayed

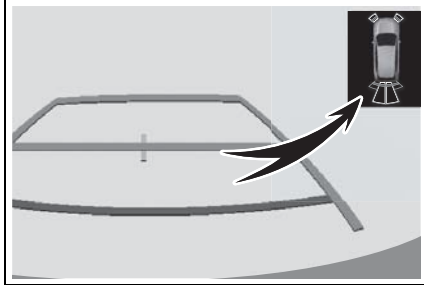

A simplified image is displayed on the upper corner of the screen when an obstacle is detected.

- When the panoramic view monitor (if equipped) is displayed

▶ Panoramic view\*

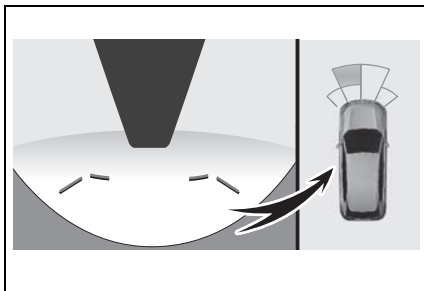

A graphic is shown when the panoramic view monitor is displayed.

\*: A simplified image is displayed on the upper corner of the screen when an obstacle is detected while magnified display is shown.

▶ Except panoramic view

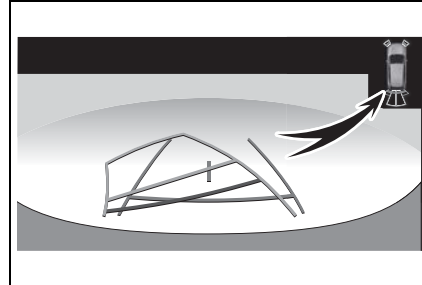



A simplified image is displayed on the upper corner of the screen when an obstacle is detected.

**Turning intuitive parking assist on/off**

The Intuitive parking assist can be enabled/disabled on the  screen of the multi-information display. (→P.94)

When the intuitive parking assist function is disabled, the intuitive parking assist OFF indicator (→P.79) illuminates on the multi-information display.

To re-enable the system, select  on the multi-information display, select  and turn it on.

If the system is disabled, it will remain off even if the engine switch is turned to ON after the engine switch has been turned off.

 **WARNING****Intuitive parking assist precautions**

Observe the following precautions.

Failing to do so may result in the vehicle being unable to be driven safely and possibly cause an accident.

- Do not use the sensor at speeds in excess of 6 mph (10 km/h).
- The sensors' detection areas and reaction times are limited. When moving forward or reversing, check the areas surrounding the vehicle (especially the sides of the vehicle) for safety, and drive slowly, using the brake to control the vehicle's speed.
- Do not install accessories near the bumpers as those areas are within the sensors' detection areas.
- The area directly under the bumpers is not detected. Thin posts or objects lower than the sensor may not be detected when approached, even if they have been detected once.

**When to disable the function**

In the following situations, disable the function as it may operate even though there is no possibility of a collision.

- The vehicle is equipped with a commercial fender pole, wireless antenna or fog lights.
- The front or rear bumper or a sensor receives a strong impact.
- A non-genuine Toyota suspension (lowered suspension, etc.) is installed.
- Towing eyelets (if equipped) are installed.
- A backlit license plate is installed.

**When using the intuitive parking assist**

In the following situations, the system may not function correctly due to a sensor malfunction, etc. Have the vehicle checked by your Toyota dealer.

- The intuitive parking assist operation display flashes or shows continuously, and a buzzer sounds when no objects are detected.
- If the area around a sensor collides with something, or is subjected to strong impact.
- If the bumper or grille collides with something.
- If the display flashes or is displayed continuously and a buzzer does not sound, except when the mute function has been turned on.



**⚠ WARNING**

**■ Notes when washing the vehicle**

Do not apply intensive bursts of water or steam to the sensor area.

Doing so may result in the sensor malfunctioning.

- When using a high pressure washer to wash the vehicle, do not spray the sensors directly, as doing so may cause a sensor to malfunction.
- When using steam to clean the vehicle, do not direct steam too close to the sensors as doing so may cause a sensor to malfunction.

**■ The system can be operated when**

- The engine switch is in ON.
- Intuitive parking assist function is on.
- The vehicle speed is less than about 6 mph (10 km/h).
- The shift lever is in a position other than P.

**■ If “Parking Assist Unavailable Clean Parking Assist Sensor” is displayed on the multi-information display**

A sensor may be covered with ice, snow, dirt, etc. Remove the ice, snow, dirt, etc., from the sensor to return the system to normal.

Also, due to ice forming on a sensor at low temperatures, a warning message may be displayed or the sensor may not be able to detect an object. Once the ice melts, the system will return to normal.

If a warning message is displayed even if the sensor is clean, there may be a sensor malfunction. Have the vehicle inspected by your Toyota

dealer.

**■ If “Parking Assist Unavailable” is displayed on the multi-information display**

- Water may be continuously flowing over the sensor surface, such as in a heavy rain. When the system determines that it is normal, the system will return to normal.
- Initialization may not have been performed after a battery terminal was disconnected and reconnected. Initialize the system. (→P.273)  
If this message continues to be displayed even after initialization, have the vehicle inspected by your Toyota dealer.

**■ If a battery terminal has been disconnected and reconnected**

The system needs to be initialized. To initialize the system, drive the vehicle straight ahead for 5 seconds or more at a speed of approximately 22 mph (35 km/h) or more.

**■ Sensor detection information**

- The sensor’s detection areas are limited to the areas around the vehicle’s front and rear bumpers.
- The following situations may occur during use.
  - Depending on the shape of the object and other factors, the detection distance may shorten, or detection may be impossible.
  - Detection may be impossible if static objects draw too close to the sensor.
  - There will be a short delay between static object detection and display (warning buzzer sounds). Even at low speeds, there is a possibility that the object will come within 11.9 in. (30 cm) before the display is shown and the warning buzzer sounds.
  - It might be difficult to hear the buzzer due to the volume of the audio system or air flow noise of the air conditioning system.

- It may be difficult to hear the sound of this system due to the buzzers of other systems.

#### ■ Conditions under which the function may not function correctly

Certain vehicle conditions and the surrounding environment may affect the ability of a sensor to correctly detect objects. Particular instances where this may occur are listed below.

- There is dirt, snow or ice on a sensor. (Cleaning the sensors will resolve this problem.)
- A sensor is frozen. (Thawing the area will resolve this problem.) In especially cold weather, if a sensor is frozen the sensor display may be displayed abnormally, or objects, such as a wall, may not be detected.
- A sensor is covered in any way.
- When a sensor or the area around a sensor is extremely hot or cold.
- On an extremely bumpy road, on an incline, on gravel, or on grass.
- The vicinity of the vehicle is noisy due to vehicle horns, motorcycle engines, air brakes of large vehicles, or other loud noises producing ultrasonic waves.
- There is another vehicle equipped with parking assist sensors in the vicinity.
- A sensor is coated with a sheet of spray or heavy rain.
- If a sensor is hit by a large amount of water, such as when driving on a flooded road.
- If the vehicle is significantly tilted.
- The vehicle is approaching a tall or curved curb.
- If objects draw too close to the sensor.

#### ■ Objects which may not be properly detected

The shape of the object may prevent the sensor from detecting it. Pay particular attention to the following objects:

- Wires, fences, ropes, etc.
- Cotton, snow and other materials that absorb sound waves
- Sharply-angled objects
- Low objects
- Tall objects with upper sections projecting outwards in the direction of your vehicle

People may not be detected if they are wearing certain types of clothing.

#### ■ Certification (Canada only)

This ISM device complies with Canadian ICES-001.

### Sensor detection display, object distance

#### ■ Detection range of the sensors

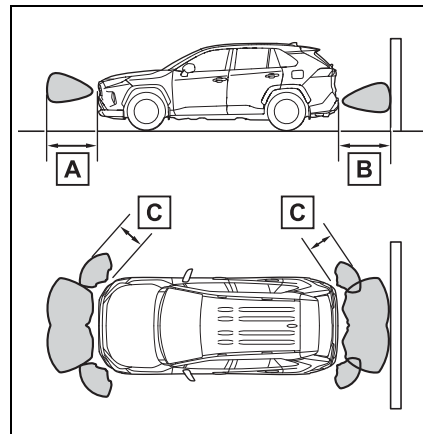

**A** Approximately 3.3 ft. (100 cm)

**B** Approximately 4.9 ft. (150 cm)

cm)

**C** Approximately 2.1 ft. (63 cm)

The diagram shows the detection range of the sensors. Note that the sensors cannot detect objects that

are extremely close to the vehicle.

The range of the sensors may change depending on the shape of the object, etc.



**Distance display**

When an object is detected by a sensor, the approximate distance to the object will be displayed on the multi-information display, navigation system (if equipped) or multimedia system (if equipped) screen. (As the distance to the object becomes short, the distance segments may blink.)



The images may differ from that shown in the illustrations.

● Approximate distance to object



- Front center sensor: 3.3 ft. (100 cm) to 2.1 ft. (63 cm)
- Rear center sensor: 4.9 ft. (150 cm) to 2.1 ft. (63 cm)

Multi-information display	Navigation or multimedia system screen	
		



● Approximate distance to object: 2.1 ft. (63 cm) to 1.6 ft. (48 cm)

Multi-information display	Navigation or multimedia system screen	
		

● Approximate distance to object: 1.6 ft. (48 cm) to 1.1 ft. (34 cm)



Multi-information display	Navigation or multimedia system screen	
		

- Approximate distance to object: 1.1 ft. (34 cm) to 0.5 ft. (15 cm)

Multi-information display*	Navigation or multimedia system screen	
		

\*: The distance segments will blink slowly.

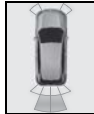
- Approximate distance to object: Less than 0.5 ft. (15 cm)

Multi-information display*	Navigation or multimedia system screen	
		

\*: The distance segments will blink rapidly.

### ■ Buzzer operation and distance to an object

A buzzer sounds when the sensors are operating.

- The buzzer beeps faster as the vehicle approaches an object.  
When the vehicle comes within approximately 1.1 ft. (34 cm) of the object, the buzzer sounds continuously.
- When 2 or more sensors simultaneously detect a static object, the buzzer sounds for the nearest object.
- Even when the sensors are operating, the buzzer will be muted in some situations. (automatic buzzer mute function)

### ■ Muting the buzzer sound

● Automatic buzzer mute function  
Even when the sensors are operating, the buzzer will be muted in the following situations:

- The distance between the vehicle and the detected object does not become shorter (except when the distance between the vehicle and object is 1.1 ft. [34 cm] or less).
- Your vehicle is moving away from the object.
- There are no detectable objects entering the path of your vehicle.

However, if another object is detected or the situation changes while the buzzer is muted, the buzzer begins sounding again.

- To mute the buzzer sound  
The buzzer can be temporarily muted by pressing  of the meter control switches while a suggestion that says mute is available is shown on the multi-information display.
- When the mute is canceled

Mute will be automatically canceled in the following situations.

- When the shift position is changed
- When the vehicle speed has reached or exceeded a certain speed
- When the Intuitive parking assist is turned off once and turned on again
- When the engine switch is turned off once and turned to ON again

■ **Customization**

The buzzer volume can be adjusted on the multi-information display. (→P.94)

**PKSB (Parking Support Brake)\***

\*: If equipped

**The Parking Support Brake system consists of the following functions that operate when driving at a low speed or backing up, such as when parking. When the system determines that the possibility of a collision with a detected object is high, a warning operates to urge the driver to take evasive action. If the system determines that the possibility of a collision with a detected object is extremely high, the brakes are automatically applied to help avoid the collision or help reduce the impact of the collision.**

**PKSB (Parking Support Brake) system**

- **Parking Support Brake function (static objects)**  
→P.282
- **Parking Support Brake function (rear-crossing vehicles) (if equipped)**  
→P.288

**⚠ WARNING****■ Limitations of the Parking Support Brake system**

Do not overly rely on the system, as doing so may lead to an accident.

Always drive while checking the safety of the surroundings of the vehicle.

Depending on the vehicle and road conditions, weather, etc., the system may not operate.

The detection capabilities of sensors and radars are limited. Always drive while checking the safety of the surroundings of the vehicle.

- The driver is solely responsible for safe driving. Always drive carefully, taking care to observe your surroundings. The Parking Support Brake system is designed to provide support to lessen the severity of collisions. However, it may not operate in some situations.
- The Parking Support Brake system is not designed to stop the vehicle completely. Additionally, even if the system has stopped the vehicle, it is necessary to depress the brake pedal immediately as brake control will be canceled after approximately 2 seconds.



**⚠ NOTICE****■ If “Parking Support Brake Unavailable” is displayed on the multi-information display and the PKSB OFF indicator is flashing**

If this message is displayed immediately after the engine switch is changed to ON, operate the vehicle carefully, paying attention to your surroundings. It may be necessary to drive the vehicle for a certain amount of time before the system returns to normal. (If the system does not return to normal after driving for a while, clean the sensors and their surrounding area on the bumpers.)

**Enabling/Disabling the Parking Support Brake**

The Parking Support Brake can be enabled/disabled on the  screen of the multi-information display. All of the Parking Support Brake functions (static objects and rear-crossing vehicles) are enabled/disabled simultaneously. (→P.94)

When the Parking Support Brake is disabled, the PKSB OFF indicator (→P.79) illuminates on the multi-information display.

To re-enable the system, select  on the multi-information display, select  and turn it on.

If the system is disabled, it will remain off even if the engine switch is turned to ON after the engine switch has been turned off.

**Display and buzzer for engine output restriction control and brake control**

If the engine output restriction control or brake control operates, a buzzer will sound and a message will be displayed on the multi-information display, navigation system (if equipped) or multimedia system (if equipped) screen, to alert the driver.

Depending on the situation, engine output restriction control will operate to either limit acceleration or restrict output as much as possible.

- Engine output restriction control is operating (acceleration restriction)

Acceleration greater than a certain amount is restricted by the system.

Navigation system (if equipped) or multimedia system (if equipped) screen: No warning displayed

Multi-information display: "Object Detected Acceleration Reduced"

PKSB OFF indicator: Not illuminated

Buzzer: Does not sound

- Engine output restriction control is operating (output restricted as much as possible)

The system has determined that stronger-than-normal brake operation is necessary.

Navigation system (if equipped) or multimedia system (if equipped)

screen: "BRAKE!"

Multi-information display: "BRAKE!"

PKSB OFF indicator: Not illuminated

Buzzer: Short beep

- Brake control is operating

The system determined that emergency braking is necessary.

Navigation system (if equipped) or multimedia system (if equipped) screen: "BRAKE!"

Multi-information display: "BRAKE!"

PKSB OFF indicator: Not illuminated

Buzzer: Short beep

- Vehicle stopped by system operation

The vehicle has been stopped by brake control operation.

Navigation system (if equipped) or multimedia system (if equipped) screen: "Press Brake Pedal"

Multi-information display: "Switch to Brake" (If the accelerator pedal is not depressed, "Brake" will be displayed.)

PKSB OFF indicator: Illuminated

Buzzer: Short beep

**System overview**

If the Parking Support Brake determines that a collision with a detected object is possible, the engine output will be restricted to restrain any increase in the vehicle speed. (Engine output restriction control: See figure 2.)

Additionally, if the accelerator pedal continues to be depressed, the brakes will be applied automatically to reduce the vehicle speed. (Brake control: See figure 3.)

- Figure 1: When the PKSB (Parking Support Brake) is not operating

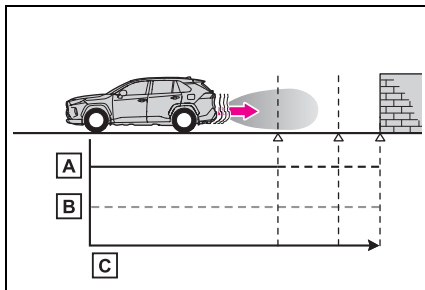

- A** Engine output
- B** Braking force
- C** Time

- Figure 2: When engine output restriction control operates

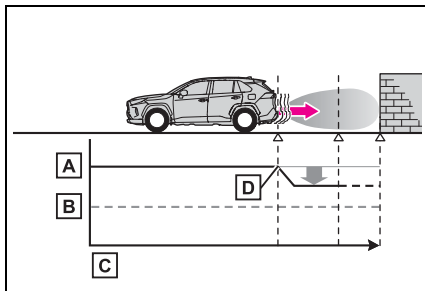

- A** Engine output
- B** Braking force
- C** Time
- D** Engine output restriction con-

trol begins operating (System determines that possibility of collision with detected object is high)

- Figure 3: When engine output restriction control and brake control operates

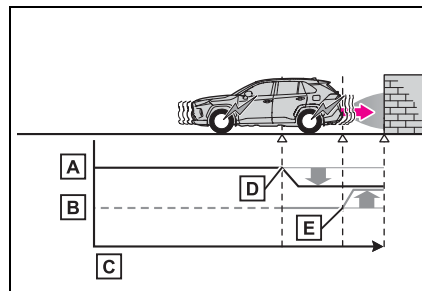

- A** Engine output
- B** Braking force
- C** Time
- D** Engine output restriction control begins operating (System determines that possibility of collision with detected object is high)
- E** Brake control begins operating (System determines that possibility of collision with detected object is extremely high)

■ **If the Parking Support Brake has operated**

If the vehicle is stopped due to operation of the Parking Support Brake, the Parking Support Brake will be disabled and the PKSB OFF indicator will illuminate. If the Parking Support Brake operates unnecessarily, brake control can be canceled by depressing the brake pedal or wait-



ing for approximately 2 seconds for it to automatically be canceled. Then, the vehicle can be operated by depressing the accelerator pedal.

■ **Re-enabling the Parking Support Brake**

To re-enable the Parking Support Brake when it is disabled due to operation of the Parking Support Brake, either enable the system again (→P.278), or turn the engine switch off and then back to ON. Additionally, if the object becomes no longer in the traveling direction of the vehicle or if the traveling direction of the vehicle changes (such as changing from moving forward to backing up, or from backing up to moving forward), the system will be re-enabled automatically.

■ **If “Parking Support Brake Unavailable” is displayed on the multi-information display and the PKSB OFF indicator is flashing**

- If this message is displayed, a sensor on the front or rear bumper may be dirty. Clean the sensors and their surrounding area on the bumpers.
- Initialization may not have been performed after a battery terminal was disconnected and reconnected. Initialize the system. (→P.281)  
If this message continues to be displayed even after initialization, have the vehicle inspected by your Toyota dealer.

■ **If “Parking Support Brake Unavailable” and “Parking Assist Unavailable Clean Parking Assist Sensor” are displayed on the multi-information display and the PKSB OFF indicator is flashing**

- A sensor may be covered with ice, snow, dirt, etc. In this case, remove the ice, snow, dirt, etc., from the sensor to return the system to normal. If this message is

shown even after removing dirt from the sensor, or shown when the sensor was not dirty to begin with, have the vehicle inspected at your Toyota dealer.

- A sensor may be frozen. Once the ice melts, the system will return to normal.
  - Water may be continuously flowing over the sensor surface, such as in a heavy rain. When the system determines that it is normal, the system will return to normal.
- **If a battery terminal has been disconnected and reconnected**

The system needs to be initialized. To initialize the system, drive the vehicle straight ahead for 5 seconds or more at a speed of approximately 22 mph (35 km/h) or more.

### Parking Support Brake function (static objects)\*

\*: If equipped

**If the sensors detect a static object, such as a wall, in the traveling direction of the vehicle and the system determines that a collision may occur due to the vehicle suddenly moving forward due to an accidental accelerator pedal operation, the vehicle moving the unintended direction due to the wrong shift position being selected, or while parking or traveling at low speeds, the system will operate to lessen the impact with the detected static object and reduce the resulting damage.**

### Examples of function operation

This function will operate in situations such as the following if an object is detected in the traveling direction of the vehicle.

- **When traveling at a low speed and the brake pedal is not depressed, or is depressed late**

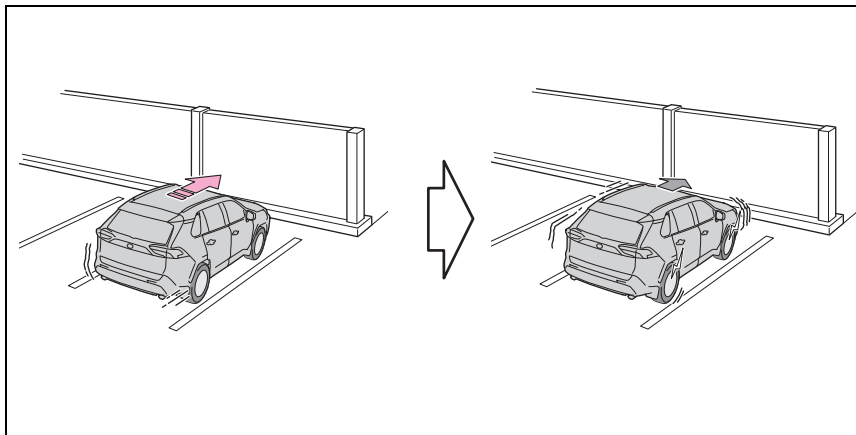

■ When the accelerator pedal is depressed excessively

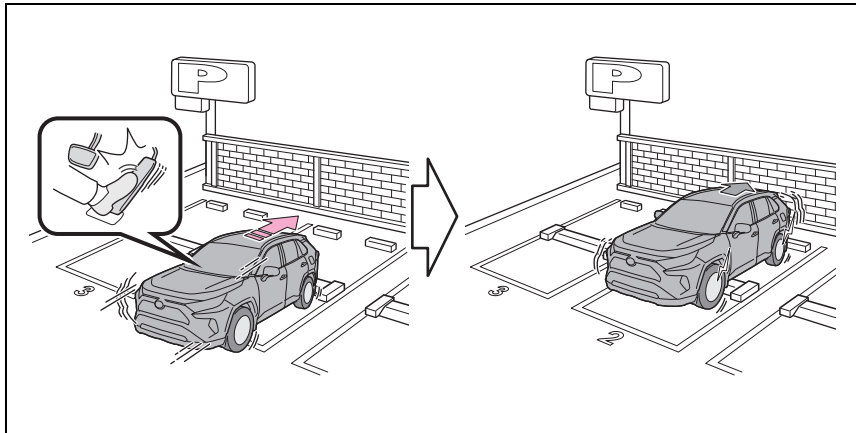

■ When the vehicle moves in the unintended direction due to the wrong shift position being selected

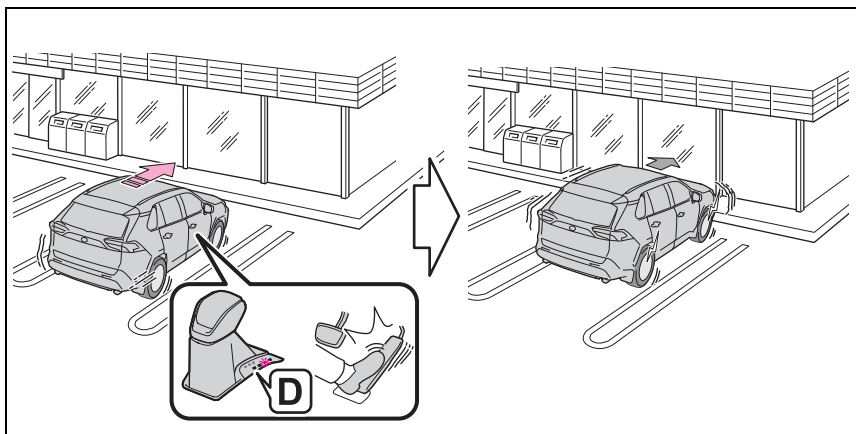

**Types of sensors**

→P.270

**⚠ WARNING**

■ **To ensure the Parking Support Brake can operate properly**

Observe the following precautions regarding the sensors (→P.270). Failure to do so may cause a sensor to not operate properly, and may cause an accident.

- Do not modify, disassemble or paint the sensors.

**WARNING**

- Do not replace a sensor with a part other than a genuine part.
- Do not subject a sensor or its surrounding area to a strong impact.
- Do not damage the sensors, and always keep them clean.
- If the area around a radar sensor is subjected to an impact, the system may not operate properly due to a sensor malfunction. Have the vehicle inspected by your Toyota dealer.

**■ Handling the suspension**

Do not modify the suspension, as changes to the height or inclination of the vehicle may prevent the sensors from detecting objects correctly or cause the system to not operate or operate unnecessarily.

**■ If the Parking Support Brake function (static objects) operates unnecessarily, such as at a railroad crossing**

In the event that the Parking Support Brake function (static objects) operates unnecessarily, such as at a railroad crossing, brake control will be canceled after approximately 2 seconds, allowing you to proceed forward and leave the area, brake control can also be canceled by depressing the brake pedal. Depressing the accelerator pedal after brake control is canceled will allow you to proceed forward and leave the area.

**■ Notes when washing the vehicle**

Do not apply intensive bursts of water or steam to the sensor area.

Doing so may result in the sensor malfunctioning.

- When using a high pressure washer to wash the vehicle, do not spray the sensors directly, as doing so may cause a sensor to malfunction.
- When using steam to clean the vehicle, do not direct steam too close to the sensors as doing so may cause a sensor to malfunction.

**■ When to disable the Parking Support Brake**

In the following situations, disable the Parking Support Brake as the system may operate even though there is no possibility of a collision.

- When inspecting the vehicle using a chassis roller, chassis dynamo or free roller
- When loading the vehicle onto a boat, truck or other transport vessel
- If the suspension has been modified or tires of a size other than specified are installed
- If the front of the vehicle is raised or lowered due to the carried load
- When equipment that may obstruct a sensor is installed, such as a towing eyelet, bumper protector (an additional trim strip, etc.), bicycle carrier, or snow plow
- When using an automatic car wash

**■ The Parking Support Brake function (static object) will operate when**

The function will operate when the PKSB OFF indicator is not illuminated or flashing (→P.77, 79) and all of the following conditions are met:

- Engine output restriction control
  - The Parking Support Brake is enabled.
  - The vehicle speed is 9 mph (15 km/h) or less.
  - There is a static object in the traveling direction of the vehicle and 6 to 13 ft. (2 to 4 m) away.
  - The Parking Support Brake determines that a stronger-than-normal brake operation is necessary to avoid a collision.
- Brake control
  - Engine output restriction control is operating
  - The Parking Support Brake determines that an immediate brake operation is necessary to avoid a collision.

**■ The Parking Support Brake function (static objects) will stop operating when**

The function will stop operating if any of the following conditions are met:

- Engine output restriction control
  - The Parking Support Brake is disabled.
  - The system determines that the collision has become avoidable with normal brake operation.
  - The static object is no longer 6 to 13 ft. (2 to 4 m) away from the vehicle or in the traveling direction of the vehicle.
- Brake control
  - The Parking Support Brake is disabled.
  - Approximately 2 seconds have elapsed since the vehicle was stopped by brake control.
  - The brake pedal is depressed after the vehicle is stopped by

brake control.

- The static object is no longer 6 to 13 ft. (2 to 4 m) away from the vehicle or in the traveling direction of the vehicle.

**■ Detection range of the Parking Support Brake function (static objects)**

The detection range of the Parking Support Brake function (static objects) differs from the detection range of the intuitive parking assist. (→P.274) Therefore, even if the intuitive parking assist detects an object and provides a warning, the Parking Support Brake function (static objects) may not start operating.

**■ Objects that the Parking Support Brake function (static objects) may not detect**

The sensors may not be able to detect certain objects, such as the following:

- Pedestrian
- Cotton, snow, and other materials that are poor reflectors of sonic waves
- Objects which are not perpendicular to the ground, are not perpendicular to the traveling direction of the vehicle, are uneven or are waving
- Low objects
- Thin objects such as wires, fences, ropes and signposts
- Objects that are extremely close to the bumper
- Sharply-angled objects
- Tall objects with upper sections projecting outwards in the direction of your vehicle

**■ Situations in which the Parking Support Brake function (static objects) may not operate**

When the shift lever is in N

**■ Intuitive parking assist buzzer**

Regardless of whether the intuitive

parking assist system is enabled or not (→P.271), if the Parking Support Brake function (static objects) is enabled (→P.278), the front or rear sensors detect an object and brake control and engine output restriction control are performed, the intuitive parking assist buzzer will sound to notify the driver of the approximate distance to the object.

■ **Situations in which the Parking Support Brake function (static objects) may operate even if there is no possibility of a collision**

In some situations, such as the following, the Parking Support Brake function (static objects) may operate even though there is no possibility of a collision.

- Vehicle surroundings
- When driving on a narrow road

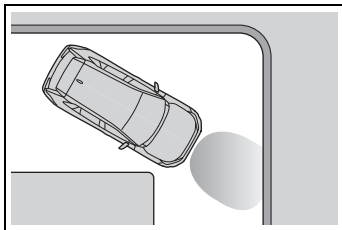

- When driving on a gravel road or in an area with tall grass

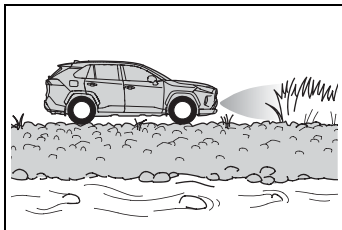

- When driving toward a banner, flag, low-hanging branch or boom barrier (such as those used at railroad crossings, toll gates and parking lots)
- When there is a structure on the roadside (such as when driving in a narrow tunnel, on a narrow bridge or on a narrow road)

- When parallel parking
- When there is a rut or hole in the surface of the road
- When driving on a metal cover (grating), such as those used for drainage ditches
- When driving up or down a steep slope
- If a sensor is hit by a large amount of water, such as when driving on a flooded road
- When loaded on ships or trucks
- Moving type automatic car wash
- Lift type parking area or multi-story parking lot
- Underground parking area
- Structures on the ground (speed bumps, cat's eyes, etc.)
- Differences in height
- When moving straight ahead or turning right
- Snow-melting pipes
- Devices for detecting vehicles, such as traffic lights, devices for detecting traffic congestion, or devices for detecting empty spaces in parking areas
- Railroad tracks
- H-shaped steel
- When there are vehicles on both sides, or there is a vehicle that resembles this vehicle
- Weather
- If a sensor is covered with ice, snow, dirt, etc. (when cleared, the system will return to normal)
- If heavy rain or water strikes a sensor
- When driving in inclement weather such as fog, snow or a sandstorm
- Strong wind is blowing
- Other sonic wave sources
- When vehicle horns, vehicle detectors, motorcycle engines, air brakes of large vehicles, the clearance sonar of other vehicles or other devices which produce ultrasonic waves are near the vehicle
- If a sticker or an electronic component, such as a backlit license plate (especially fluorescent type), fog lights, fender pole or wireless antenna is installed near a sensor

- Changes in the vehicle posture
  - If the vehicle is significantly tilted
  - If the front of the vehicle is raised or lowered due to the carried load
  - If the orientation of a sensor has been changed due to a collision or other impact

■ Situations in which the Parking Support Brake function (static objects) may not operate properly

In some situations, such as the following, this function may not operate properly.

- Weather
  - When a sensor or the area around a sensor is extremely hot or cold

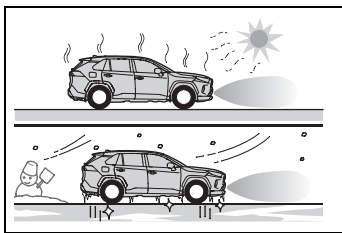

- When strong winds are blowing

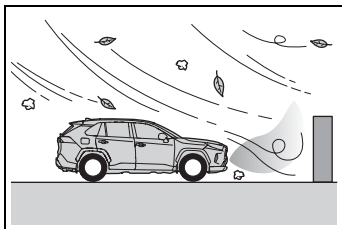

- If a sensor is covered with ice, snow, dirt, etc. (when cleared, the system will return to normal)
- If heavy rain or water strikes a sensor
- When driving in inclement weather such as fog, snow or a sandstorm
- A sensor is frozen. (Thawing the area will resolve this problem.)
- Vehicle surroundings
  - When an object that cannot be detected is between the vehicle and a detected object
  - If an object such as a vehicle, motorcycle, bicycle or pedestrian

- cuts in front of the vehicle or runs out from the side of the vehicle
- The vehicle is approaching a tall or curved curb.
- On an extremely bumpy road, on an incline, on gravel, or on grass.
- The objects draw too close to the sensor.
- Other sonic waves sources
  - When vehicle horns, vehicle detectors, motorcycle engines, air brakes of large vehicles, the clearance sonar of other vehicles or other devices which produce ultrasonic waves are near the vehicle
  - If a sticker or an electronic component, such as a backlit license plate (especially fluorescent type), fog lights, fender pole or wireless antenna is installed near a sensor

- Changes in the vehicle
  - If the vehicle is significantly tilted
  - If the front of the vehicle is raised or lowered due to the carried load
  - If the orientation of a sensor has been changed due to a collision or other impact
- When equipment that may obstruct a sensor is installed, such as a towing eyelet, bumper protector (an additional trim strip, etc.), bicycle carrier, or snow plow
- If the suspension has been modified or tires of a size other than specified are installed
- If paint or a sticker is applied to the sensor

### Parking Support Brake function (rear-crossing vehicles)\*

\*: If equipped

**If a rear radar sensor detects a vehicle approaching from the right or left at the rear of the vehicle and the system determines that the possibility of a collision is high, this function will perform brake control to reduce the likelihood of an impact with the approaching vehicle.**

### Examples of function operation

This function will operate in situations such as the following if a vehicle is detected in the traveling direction of the vehicle.

- **When reversing, a vehicle is approaching and the brake pedal is not depressed, or is depressed late**

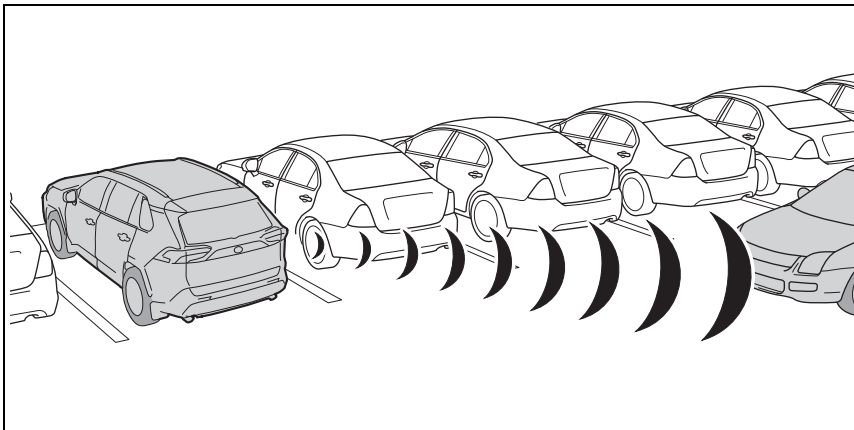

### Types of sensors

→P.263

### ⚠ WARNING

■ **To ensure the Parking Support Brake (rear-crossing vehicles) can operate properly**

Observe the following precautions regarding the rear radar sensors (→P.263). Failure to do so may cause a sensor to not operate properly, and may cause an accident.





**WARNING**

- Do not modify, disassemble or paint the sensors.
- Do not replace a rear radar sensor with a part other than a genuine part.
- Do not damage the rear radar sensors, and always keep the radar sensors and their surrounding area on the bumper clean.
- If the area around a rear radar sensor is subjected to an impact, the system may not operate properly due to a sensor malfunction. Have the vehicle inspected by your Toyota dealer.
- Observe the rear radar sensor handling precautions. (→P.263)

**■ The Parking Support Brake function (rear-crossing vehicles) will operate when**

The function will operate when the PKSB OFF indicator is not illuminated or flashing (→P.77, 79) and all of the following conditions are met:

- Engine output restriction control
  - The Parking Support Brake is enabled.
  - The vehicle speed is 9 mph (15 km/h) or less.
  - Vehicles are approaching from the right or left at the rear of the vehicle at a traveling speed of less than approximately 5 mph (8 km/h)
  - The shift lever is in R.
  - The Parking Support Brake determines that a stronger than normal brake operation is necessary to avoid a collision with an approaching vehicle.
- Brake control
  - Engine output restriction control is operating

- The Parking Support Brake determines that an emergency brake operation is necessary to avoid a collision with an approaching vehicle.

**■ The Parking Support Brake function (rear-crossing vehicles) will stop operating when**

The function will stop operating if any of the following conditions are met:

- Engine output restriction control
- The Parking Support Brake is disabled.
- The collision becomes avoidable with normal brake operation.
- A vehicle is no longer approaching from the right or left at the rear of the vehicle.
- Brake control
  - The Parking Support Brake is disabled.
  - Approximately 2 seconds have elapsed since the vehicle was stopped by brake control.
  - The brake pedal is depressed after the vehicle is stopped by brake control.
  - A vehicle is no longer approaching from the right or left at the rear of the vehicle.

**■ Detection area of the Parking Support Brake function (rear-crossing vehicles)**

The detection area of the Parking Support Brake function (rear-crossing vehicles) differs from the detection area of the RCTA function (→P.267). Therefore, even if the RCTA function detects a vehicle and provides an alert, the Parking Support Brake function (rear-crossing vehicles) may not start operating.

**■ Conditions under which the Parking Support Brake function (rear-crossing vehicles) will not detect a vehicle**

The Parking Support Brake function (rear-crossing vehicles) is not designed to detect the following

types of vehicles and/or objects:

- Vehicles approaching from directly behind
- Vehicles backing up in a parking space next to your vehicle
- Vehicles that the sensors cannot detect due to obstructions

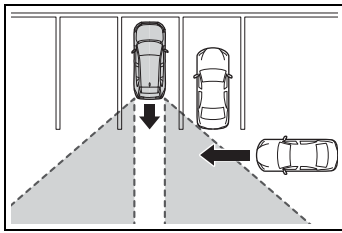

- Vehicles which suddenly accelerate or decelerate near your vehicle
- Guardrails, walls, signs, parked vehicles and similar stationary objects\*
- Small motorcycles, bicycles, pedestrians, etc.\*
- Vehicles moving away from your vehicle
- Vehicles approaching from the parking spaces next to your vehicle\*
- Objects which are extremely close to a radar sensor\*
- Vehicles which are approaching from the right or left at the rear of the vehicle at a traveling speed of less than approximately 5 mph (8 km/h)
- Vehicles which are approaching from the right or left at the rear of the vehicle at a traveling speed of more than approximately 15 mph (24 km/h)

\*: Depending on the conditions, detection of a vehicle and/or object may occur.

#### ■ Situations in which the system may operate even though there is no possibility of a collision

In some situations such as the following, the Parking Support Brake function (rear-crossing vehicles) may operate even though there is no possibility of a collision.

- When the parking space faces a street and vehicles are being driven on the street

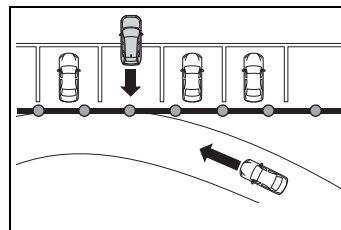

- When a detected vehicle turns while approaching the vehicle

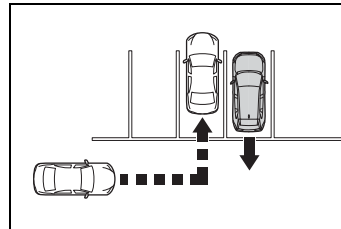

- When a vehicle passes by the side of your vehicle

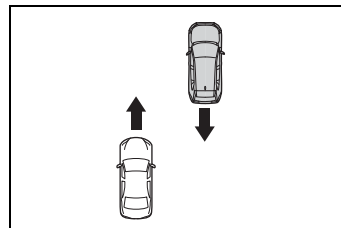

- When the distance between your vehicle and metal objects, such as a guardrail, wall, sign, or parked vehicle, which may reflect electrical waves toward the rear of the vehicle, is short

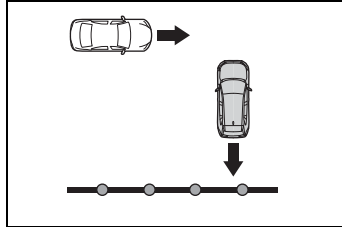

- When there are spinning objects near your vehicle such as the fan of an air conditioning unit
- When water is splashed or sprayed toward the rear bumper, such as from a sprinkler

■ **Situations in which the Parking Support Brake function (rear-crossing vehicles) may not operate properly**

In some situations, such as the following, the radar sensors may not detect an object and this function may not operate properly

- Stationary objects
- When a sensor or the area around a sensor is extremely hot or cold
- If the rear bumper is covered with ice, snow, dirt, etc.
- When it is raining heavily or water strikes the vehicle
- When the detection area of a radar sensor is obstructed by an adjacent vehicle
- If the vehicle is significantly tilted
- When equipment that may obstruct a sensor is installed, such as a towing eyelet, bumper protector (an additional trim strip, etc.), bicycle carrier, or snow plow
- If the suspension has been modified or tires of a size other than specified are installed
- If the front of the vehicle is raised or lowered due to the carried load
- If a sticker or an electronic component, such as a backlit license plate (especially fluorescent type), fog lights, fender pole or wireless

antenna is installed near a radar sensor

- If the orientation of a radar sensor has been changed
- When multiple vehicles are approaching with only a small gap between each vehicle
- If a vehicle is approaching the rear of your vehicle rapidly
- Situations in which the radar sensor may not detect a vehicle
- When a vehicle approaches from the right or left at the rear of the vehicle while you are turning while backing up
- When turning while backing up

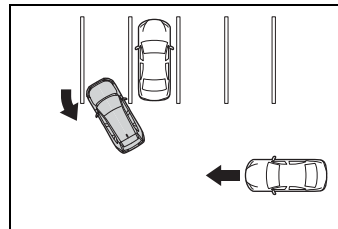

- When backing out of a shallow angle parking spot

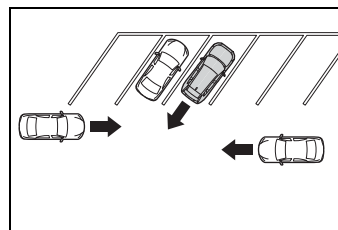

- When backing up on a slope with a sharp change in grade

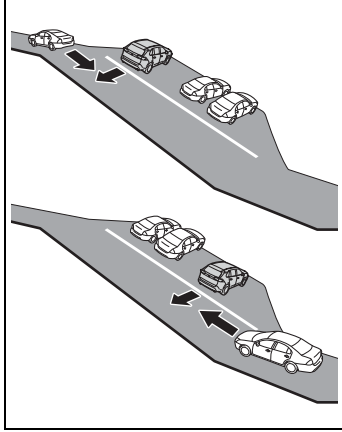

- When a vehicle turns into the detection area

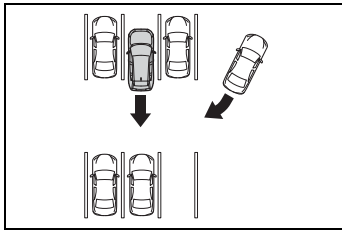

### Rear view monitor system\*

\*: If equipped

**The rear view monitor system assists the driver by displaying an image of the view behind the vehicle with fixed guide lines on the screen while backing up, for example while parking.**

- The screen illustrations used in this text are intended as examples, and may differ from the image that is actually displayed on the screen.

### Driving precautions

The rear view monitor system is a supplemental device intended to assist the driver when backing up. When backing up, be sure to visually check all around the vehicle both directly and using the mirrors before proceeding. If you do not, you may hit another vehicle, and could possibly cause an accident.

Pay attention to the following precautions when using the rear view monitor system.

**⚠ WARNING**

- Never depend on the rear view monitor system entirely when backing up. The image and the position of the guide lines displayed on the screen may differ from the actual state. Use caution, just as you would when backing up any vehicle.
- Be sure to back up slowly, depressing the brake pedal to control vehicle speed.
- The instructions given are only guide lines. When and how much to turn the steering wheel will vary according to traffic conditions, road surface conditions, vehicle condition, etc. when parking. It is necessary to be fully aware of this before using the rear view monitor system.
- When parking, be sure to check that the parking space will accommodate your vehicle before maneuvering into it.
- Do not use the rear view monitor system in the following cases:
  - On icy or slick road surfaces, or in snow
  - When using tire chains or emergency tires
  - When the back door is not closed completely
  - On roads that are not flat or straight, such as curves or slopes

- In low temperatures, the screen may darken or the image may become faint. The image could distort when the vehicle is moving, or you may become unable to see the image on the screen. Be sure to visually check all around the vehicle both directly and using the mirrors before proceeding.
- If the tire sizes are changed, the position of the fixed guide lines displayed on the screen may change.
- The camera uses a special lens. The distances between objects and pedestrians that appear in the image displayed on the screen will differ from the actual distances. (→P.295)

**Screen description**

The rear view monitor system screen will be displayed if the shift lever is shifted to the “R” position while the engine switch is in ON.

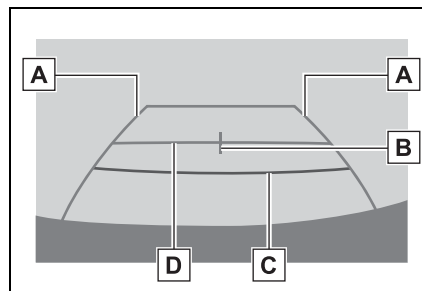

**A** Vehicle width guide line  
 Displays a guide path when the vehicle is being backed straight up.  
 • The displayed width is wider than the actual vehicle width.

**B** Vehicle center guide line

This line indicates the estimated vehicle center on the ground.

**C** Distance guide line

Shows distance behind the vehicle.

- Displays a point approximately 1.5 ft. (0.5 m) (red) from the edge of the bumper.

**D** Distance guide line

Shows distance behind the vehicle.

- Displays a point approximately 3 ft. (1 m) (blue) from the edge of the bumper.

**Canceling rear view monitor system**

The rear view monitor system is canceled when the shift lever is shifted into any position other than the “R” position.

**Rear view monitor system precautions**

**Area displayed on screen**

The rear view monitor system displays an image of the view from the bumper of the rear area of the vehicle.

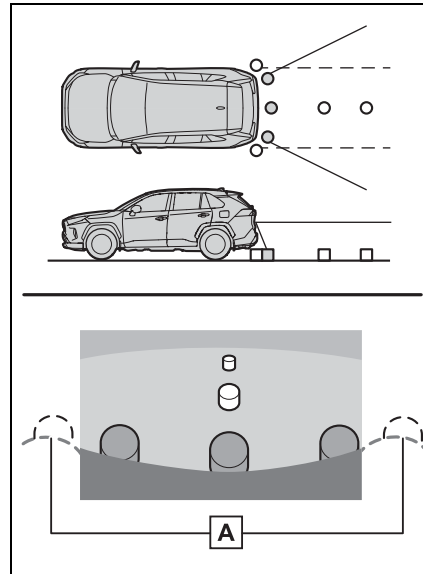

**A** Corners of bumper

- The area around both corners of the bumper will not be displayed.
- The image adjustment procedure for the rear view monitor system screen is the same as the procedure for adjusting the screen. (→P.388)
- The area displayed on the screen may vary according to vehicle orientation conditions.
- Objects which are close to either corner of the bumper or under the bumper cannot be displayed.
- The camera uses a special lens. The distance of the image that appears on the screen differs from the actual distance.
- Items which are located higher than the camera may not be displayed on the monitor.

**The camera**

The camera for the rear view

monitor system is located as shown in the illustration.

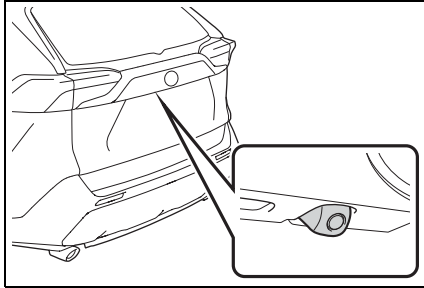

■ **Using the camera**

If dirt or foreign matter (such as water droplets, snow, mud, etc.) is adhering to the camera, it cannot transmit a clear image. In this case, flush it with a large quantity of water and wipe the camera lens clean with a soft and wet cloth.

 **NOTICE**

- The rear view monitor system may not operate properly in the following cases.
  - If the back of the vehicle is hit, the position and mounting angle of the camera may change.
  - As the camera has a water proof construction, do not detach, disassemble or modify it. This may cause incorrect operation.
  - When cleaning the camera lens, flush the camera with a large quantity of water and wipe it with a soft and wet cloth. Strongly rubbing the camera lens may cause the camera lens to be scratched and unable to transmit a clear image.
  - Do not allow organic solvent, car wax, window cleaner or a glass coating to adhere to the camera. If this happens, wipe it off as soon as possible.
  - If the temperature changes rapidly, such as when hot water is poured on the vehicle in cold weather, the system may not operate normally.
  - When washing the vehicle, do not apply intensive bursts of water to the camera or camera area. Doing so may result in the camera malfunctioning.
- Do not expose the camera to strong impact as this could cause a malfunction. If this happens, have the vehicle inspected by your Toyota dealer as soon as possible.

**Differences between the screen and the actual road**

- The distance guide lines and the vehicle width guide lines

may not actually be parallel with the dividing lines of the parking space, even when they appear to be so. Be sure to check visually.

- The distances between the vehicle width guide lines and the left and right dividing lines of the parking space may not be equal, even when they appear to be so. Be sure to check visually.
- The distance guide lines give a distance guide for flat road surfaces. In any of the following situations, there is a margin of error between the guide lines on the screen and the actual distance/course on the road.

■ **When the ground behind the vehicle slopes up sharply**

The distance guide lines will appear to be closer to the vehicle than the actual distance. Because of this, objects will appear to be farther away than they actually are. In the same way, there will be a margin of error between the fixed guide lines and the actual distance/course on the road.

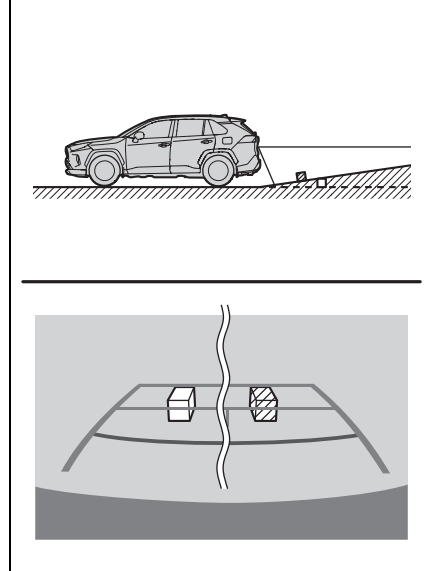

■ **When the ground behind the vehicle slopes down sharply**

The distance guide lines will appear to be farther from the vehicle than the actual distance. Because of this, objects will appear to be closer than they actually are. In the same way, there will be a margin of error between the guide lines and the actual distance/course on the road.



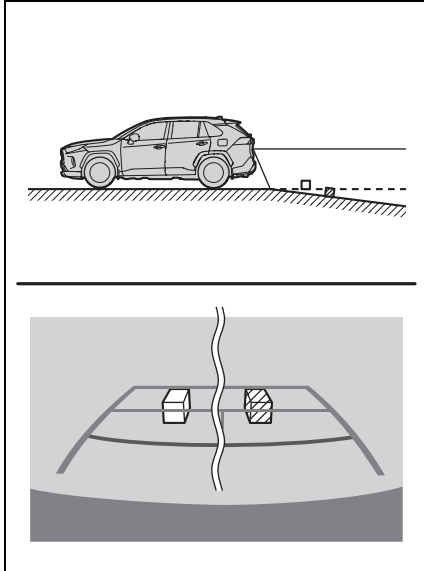

■ **When any part of the vehicle sags**

When any part of the vehicle sags due to the number of passengers or the distribution of the load, there is a margin of error between the fixed guide lines on the screen and the actual distance/course on the road.

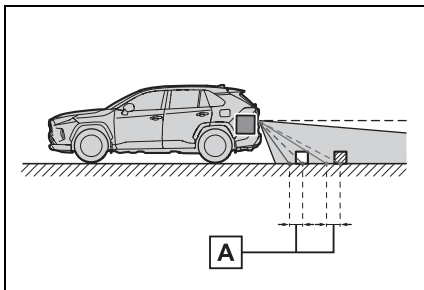

**A** A margin of error

**When approaching three-dimensional objects**

The distance guide lines are displayed according to flat surfaced objects (such as the road). It is not possible to determine the position of three-dimensional objects (such as vehicles) using the vehicle width guide lines and distance guide lines. When approaching a three-dimensional object that extends outward (such as the flatbed of a truck), be careful of the following.

■ **Vehicle width guide lines**

Visually check the surroundings and the area behind the vehicle. In the case shown below, the truck appears to be outside of the vehicle width guide lines and the vehicle does not look as if it hits the truck. However, the rear body of the truck may actually cross over the vehicle width guide lines. In reality if you back up as guided by the vehicle width guide lines, the vehicle may hit the truck.

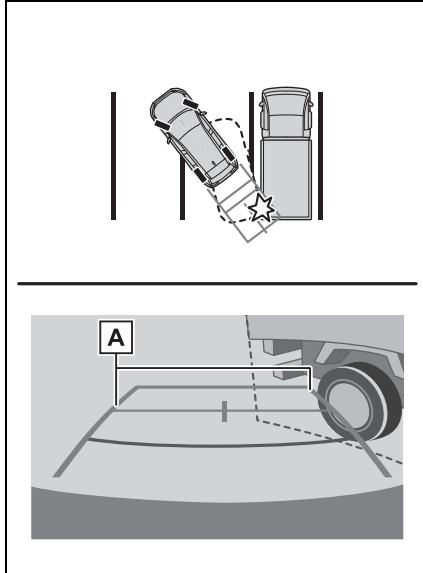

**A** Vehicle width guide lines

#### ■ Distance guide lines

Visually check the surroundings and the area behind the vehicle. On the screen, it appears that a truck is parking at point **B**. However, in reality if you back

up to point **A**, you will hit the truck. On the screen, it appears that **A** is closest and **C** is farthest away. However, in reality, the distance to **A** and **C** is the same, and **B** is farther than **A** and **C**.

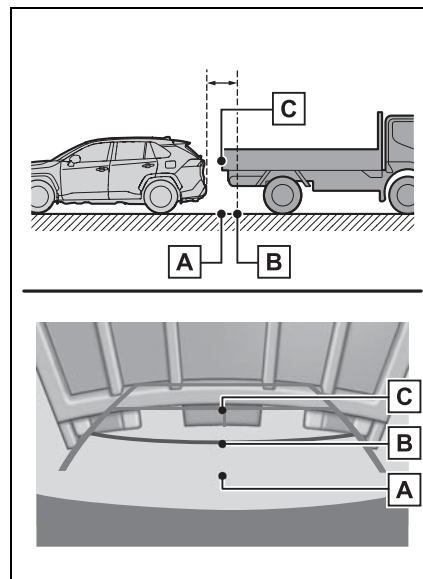

### Things you should know

#### If you notice any symptoms

If you notice any of the following symptoms, refer to the likely cause and the solution, and re-check.

If the symptom is not resolved by the solution, have the vehicle inspected by your Toyota dealer.

Symptom	Likely cause	Solution
The image is difficult to see	<ul style="list-style-type: none"> <li>• The vehicle is in a dark area</li> <li>• The temperature around the lens is either high or low</li> <li>• The outside temperature is low</li> <li>• There are water droplets on the camera</li> <li>• It is raining or humid</li> <li>• Foreign matter (mud etc.) is adhering to the camera</li> <li>• Sunlight or headlights are shining directly into the camera</li> <li>• The vehicle is under fluorescent lights, sodium lights, mercury lights etc.</li> </ul>	<p>Back up while visually checking the vehicle's surroundings. (Use the monitor again once conditions have been improved.)</p> <p>The procedure for adjusting the picture quality of the rear view monitor system is the same as the procedure for adjusting the screen. (→P.388)</p>
The image is blurry	Dirt or foreign matter (such as water droplets, snow, mud etc.) is adhering to the camera.	Flush the camera with a large quantity of water and wipe the camera lens clean with a soft and wet cloth.
The image is out of alignment	The camera or surrounding area has received a strong impact.	Have the vehicle inspected by your Toyota dealer.
The fixed guide lines are very far out of alignment	The camera position is out of alignment.	Have the vehicle inspected by your Toyota dealer.
	<ul style="list-style-type: none"> <li>• The vehicle is tilted (there is a heavy load on the vehicle, tire pressure is low due to a tire puncture, etc.)</li> <li>• The vehicle is used on an incline.</li> </ul>	<p>If this happens due to these causes, it does not indicate a malfunction.</p> <p>Back up while visually checking the vehicle's surroundings.</p>

### Toyota parking assist monitor\*

\*: If equipped

**The parking assist monitor assists the driver by displaying an image of the view behind the vehicle while backing up, for example while parking.**

**When the display is changed to the wide rear view mode, a wider lateral view behind the vehicle will be displayed.**

- The screen illustrations used in this text are intended as examples, and may differ from the image that is actually displayed on the screen.

### Driving precautions

The parking assist monitor is a supplemental device intended to assist the driver when backing up. When backing up, be sure to visually check all around the vehicle both directly and using the mirrors before proceeding. If you do not, you may hit another vehicle, and could possibly cause an accident.

Pay attention to the following precautions when using the parking assist monitor.

### WARNING

- Never depend on the parking assist monitor entirely when backing up. The image and the position of the guide lines displayed on the screen may differ from the actual state. Use caution, just as you would when backing up any vehicle.
- Be sure to back up slowly, depressing the brake pedal to control vehicle speed.
- If you seem likely to hit nearby vehicles, obstacles, people or mount the shoulder, depress the brake pedal to stop the vehicle.
- The instructions given are only guidelines. When and how much to turn the steering wheel will vary according to traffic conditions, road surface conditions, vehicle condition, etc. when parking. It is necessary to be fully aware of this before using the parking assist system.
- When parking, be sure to check that the parking space will accommodate your vehicle before maneuvering into it.
- Do not use the parking assist monitor in the following cases:
  - On icy or slick road surfaces, or in snow
  - When using tire chains or emergency tires
  - When the back door is not closed completely
  - On roads that are not flat or straight, such as curves or slopes
  - If the suspension has been modified or tires of a size other than specified are installed

**⚠ WARNING**

- In low temperatures, the screen may darken or the image may become faint. The image could distort when the vehicle is moving, or you may become unable to see the image on the screen. Be sure to visually check all around the vehicle both directly and using the mirrors before proceeding.
- If the tire sizes are changed, the position of the guide lines displayed on the screen may change.
- The camera uses a special lens. The distances between objects and pedestrians that appear in the image displayed on the screen will differ from the actual distances. (→P.307)

**Screen display**

The parking assist monitor screen will be displayed if the shift lever is shifted to the “R” while the engine switch is in ON. Each time the display mode switching button is selected, the mode will change as follows:

- ▶ Rear view  
Displays the rear view of the vehicle.

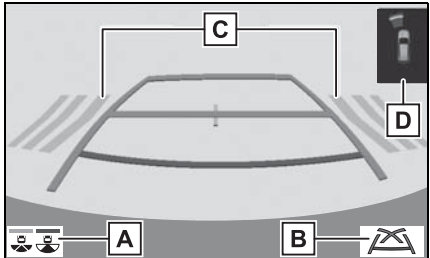

**A** Display mode switching button

Each time the button is selected, the rear view mode and the wide rear view mode are switched.

**B** Guide line switching button  
Select to switch the guide line mode. (→P.302)

- Each time the button is selected, the display mode changes in the following order:

Estimated course line display mode  
→ Parking assist guide line display mode  
→ Distance guide line display mode.

**C** Rear Cross Traffic Alert\*

When a sensor detects a vehicle approaching from the rear, the direction of the vehicle approaching from the rear is displayed and the buzzer sounds.

**D** Intuitive parking assist\*

When a sensor detects a stationary object, the direction of and the approximate distance to the a stationary object are displayed and the buzzer sounds.

\*: If equipped

- ▶ Wide rear view  
Displays a near 180° image from the rear view camera.

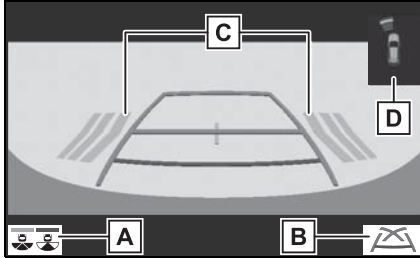

**A** Display mode switching button

Each time the button is selected, the rear view mode and the wide rear view mode are switched.

**B** Guide line switching button

Select to switch the guide line mode. (→P.302)

- Each time the button is selected, the display mode changes in the following order:

Estimated course line display mode  
→ Parking assist guide line display mode  
→ Distance guide line display mode.

**C** Rear Cross Traffic Alert\*

When a sensor detects a stationary object, the direction of stationary object is displayed and the buzzer sounds.

**D** Intuitive parking assist\*

When a sensor detects an obstacle, the direction of and the approximate distance to the obstacle are displayed and the buzzer sounds.

\*: If equipped

- For details about the Rear Cross Traffic Alert function (→P.267) and intuitive parking assist. (→P.270)

**! WARNING**

- As the Rear Cross Traffic Alert display is displayed over the camera view, it may be difficult to see the Rear Cross Traffic Alert display depending on the color and brightness of the surrounding area.

**Canceling Toyota parking assist monitor**

The parking assist monitor is canceled when the shift lever is shifted into any position other than the “R”.

**Using the system**

Use any of the following modes.

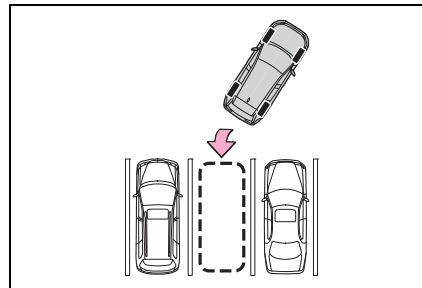

- ▶ Estimated course line display mode (→P.303)

Estimated course lines are displayed which move in accordance with the operation of the steering wheel.

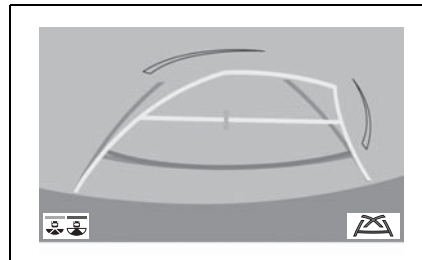

- ▶ Parking assist guide line display mode (→P.304)

The steering wheel return points (parking assist guide lines) are displayed.

This mode is recommended for

those who are comfortable with parking the vehicle without the aid of the estimated course lines.

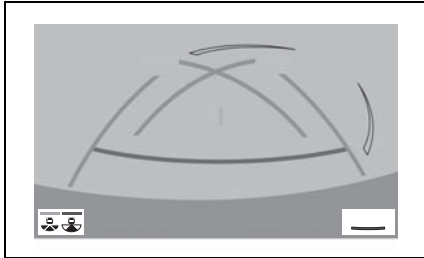

▶ Distance guide line display mode (→P.305)

Distance guide lines only are displayed.

This mode is recommended for those who are comfortable with parking the vehicle without the aid of the guide lines.

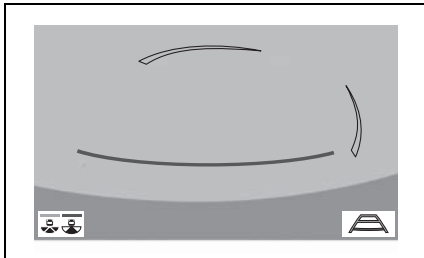

### Estimated course line display mode

#### Screen description

▶ Rear view

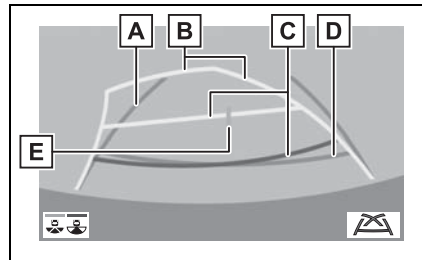

**A** Vehicle width guide line  
Displays a guide path when the vehicle is being backed straight up.

**B** Estimated course lines  
Show an estimated course when the steering wheel is turned.

**C** Distance guide lines  
Show distance behind the vehicle when the steering wheel is turned.

- The guide lines move in conjunction with the estimated course lines.
- The guide lines display points approximately 1.5 ft. (0.5 m) (red) and approximately 3 ft. (1 m) (yellow) from the center of the edge of the bumper.

**D** Distance guide line  
Shows distance behind the vehicle.

- Displays a point approximately 1.5 ft. (0.5 m) (blue) from the edge of the bumper.

**E** Vehicle center guide line  
Indicates the estimated vehicle center on the ground.

► Wide rear view

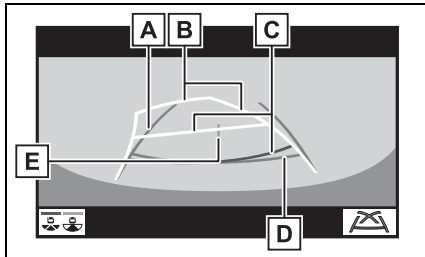

- A** Vehicle width guide line  
Displays a guide path when the vehicle is being backed straight up.
- B** Estimated course lines  
Show an estimated course when the steering wheel is turned.
- C** Distance guide lines  
Show distance behind the vehicle when the steering wheel is turned.
  - The guide lines move in conjunction with the estimated course lines.
  - The guide lines display points approximately 1.5 ft. (0.5 m) (red) and approximately 3 ft. (1 m) (yellow) from the center of the edge of the bumper.
- D** Distance guide line  
Shows distance behind the vehicle.
  - Displays a point approximately 1.5 ft. (0.5 m) (blue) from the edge of the bumper.
- E** Vehicle center guide line  
Indicates the estimated vehicle center on the ground.

**⚠ WARNING**

- If the steering wheel is straight and the vehicle width guide lines and the estimated course lines are not in alignment, have the vehicle inspected by your Toyota dealer.

**Parking assist guide line display mode**

**Screen description**

► Rear view

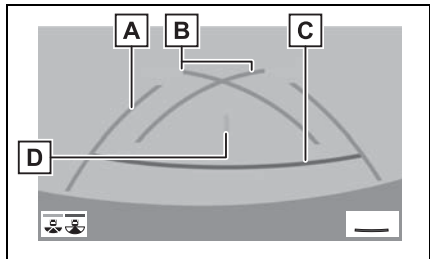

- A** Vehicle width guide line  
Displays a guide path when the vehicle is being backed straight up.
  - The displayed width is wider than the actual vehicle width.
- B** Parking assist guide lines  
Show the path of the smallest turn possible behind the vehicle.
- C** Distance guide line  
Shows distance behind the vehicle.
  - Displays points approximately 1.5 ft. (0.5 m) (red) from the edge of the bumper.
- D** Vehicle center guide line  
Indicates the estimated vehicle center on the ground.



► Wide rear view

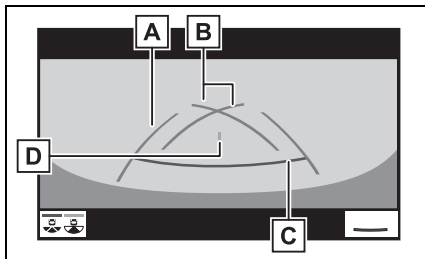

- A** Vehicle width guide line  
Displays a guide path when the vehicle is being backed straight up.
  - The displayed width is wider than the actual vehicle width.
- B** Parking assist guide lines  
Show the path of the smallest turn possible behind the vehicle.
- C** Distance guide line  
Shows distance behind the vehicle.
  - Displays points approximately 1.5 ft. (0.5 m) (red) from the edge of the bumper.
- D** Vehicle center guide line  
Indicates the estimated vehicle center on the ground.

**Distance guide line display mode**

**Screen description**

► Rear view

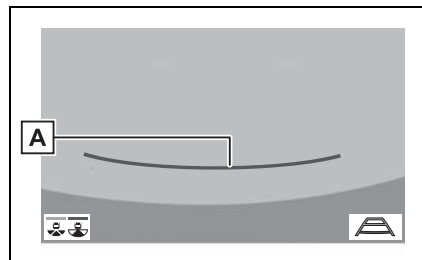

- A** Distance guide lines  
Shows distance behind the vehicle.
  - Displays points approximately 1.5 ft. (0.5 m) (red) from the edge of the bumper.

► Wide rear view

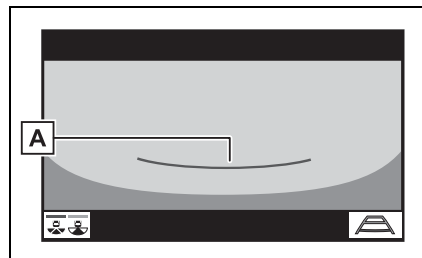

- A** Distance guide lines  
Shows distance behind the vehicle.

- Displays points approximately 1.5 ft. (0.5 m) from the edge of the bumper.

**Toyota parking assist monitor precautions**

**Area displayed on screen**

The parking assist monitor displays an image of the view from the bumper of the rear area of the vehicle.

► Rear view

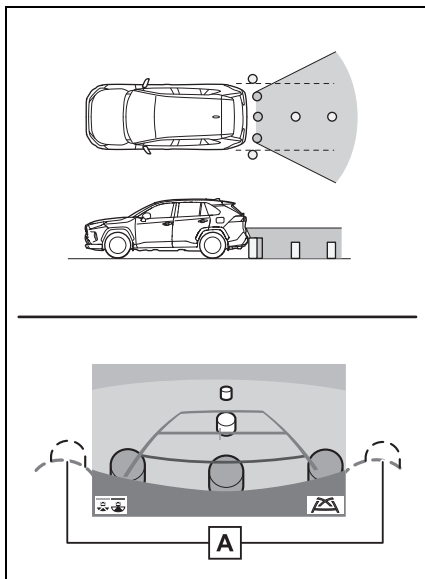

**A** Corners of bumper

- The area around both corners of the bumper will not be displayed.

► Wide rear view

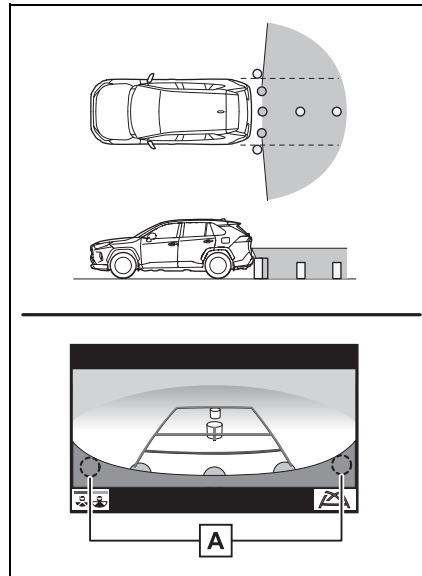

**A** Corners of bumper

- The area around both corners of the bumper will not be displayed.

- The image adjustment procedure for the parking assist monitor screen is the same as the procedure for adjusting the screen display. (→P.388)
- The area displayed on the screen may vary according to vehicle orientation conditions.
- Objects which are close to either corner of the bumper or under the bumper cannot be displayed.
- The camera uses a special lens. The distance of the image that appears on the screen differs from the actual distance.
- Items which are located higher than the camera may not be displayed on the monitor.

**The camera**

The camera for the parking assist monitor is located as shown in the illustration.

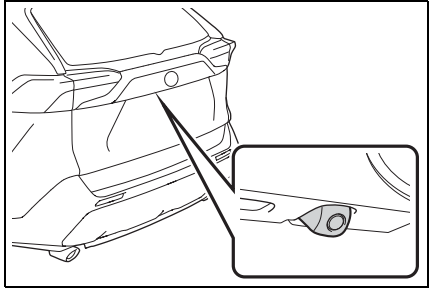

**Using the camera**

If dirt or foreign matter (such as water droplets, snow, mud, etc.) is adhering to the camera, it cannot transmit a clear image. In this case, flush it with a large quantity of water and wipe the camera lens clean with a soft and wet cloth.

**NOTICE**

- The parking assist monitor may not operate properly in the following cases.
  - If the back of the vehicle is hit, the position and mounting angle of the camera may change.
  - As the camera has a water proof construction, do not detach, disassemble or modify it. This may cause incorrect operation.
  - When cleaning the camera lens, flush the camera with a large quantity of water and wipe it with a soft and wet cloth. Strongly rubbing the camera lens may cause the camera lens to be scratched and unable to transmit a clear image.
  - Do not allow organic solvent, car wax, window cleaner or a glass coating to adhere to the camera. If this happens, wipe it off as soon as possible.
  - If the temperature changes rapidly, such as when hot water is poured on the vehicle in cold weather, the system may not operate normally.
  - When washing the vehicle, do not apply intensive bursts of water to the camera or camera area. Doing so may result in the camera malfunctioning.
- Do not expose the camera to strong impact as this could cause a malfunction. If this happens, have the vehicle inspected by your Toyota dealer as soon as possible.

**Differences between the screen and the actual road**

- The distance guide lines and the vehicle width guide lines

may not actually be parallel with the dividing lines of the parking space, even when they appear to be so. Be sure to check visually.

- The distances between the vehicle width guide lines and the left and right dividing lines of the parking space may not be equal, even when they appear to be so. Be sure to check visually.
- The distance guide lines give a distance guide for flat road surfaces. In any of the following situations, there is a margin of error between the guide lines on the screen and the actual distance/course on the road.

■ **When the ground behind the vehicle slopes up sharply**

The distance guide lines will appear to be closer to the vehicle than the actual distance. Because of this, objects will appear to be farther away than they actually are. In the same way, there will be a margin of error between the guidelines and the actual distance/course on the road.

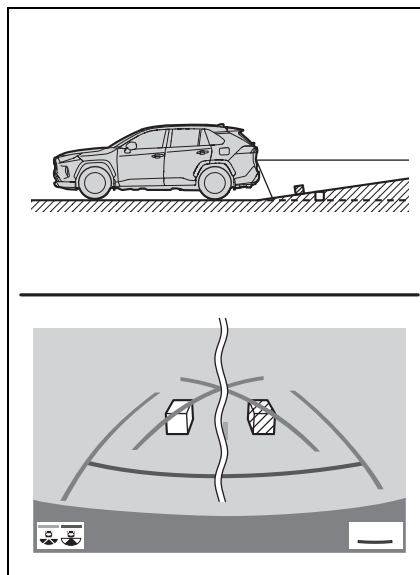

■ **When the ground behind the vehicle slopes down sharply**

The distance guide lines will appear to be farther from the vehicle than the actual distance. Because of this, objects will appear to be closer than they actually are. In the same way, there will be a margin of error between the guidelines and the actual distance/course on the road.

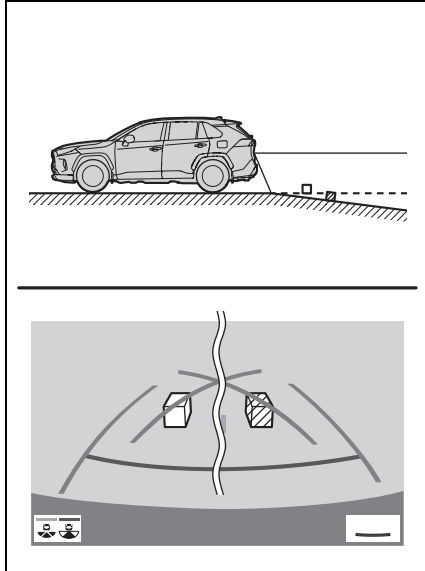

■ **When any part of the vehicle sags**

When any part of the vehicle sags due to the number of passengers or the distribution of the load, there is a margin of error between the guide lines on the screen and the actual distance/course on the road.

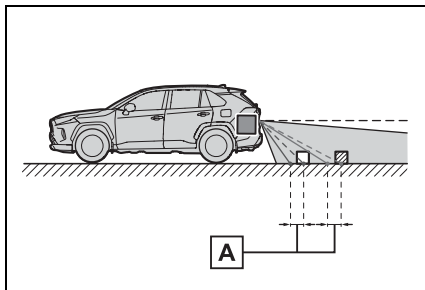

**A** A margin of error

**When approaching three-dimensional objects**

The estimated course lines target flat surfaced objects (such as the road). It is not possible to determine the position of three-dimensional objects (such as vehicles) using the estimated course lines and distance guide lines. When approaching a three-dimensional object that extends outward (such as the flatbed of a truck), be careful of the following.

■ **Estimated course lines**

Visually check the surroundings and the area behind the vehicle. In the case shown below, the truck appears to be outside of the estimated course lines and the vehicle does not look as if it hits the truck. However, the rear body of the truck may actually cross over the estimated course lines. In reality if you back up as guided by the estimated course lines, the vehicle may hit the truck.

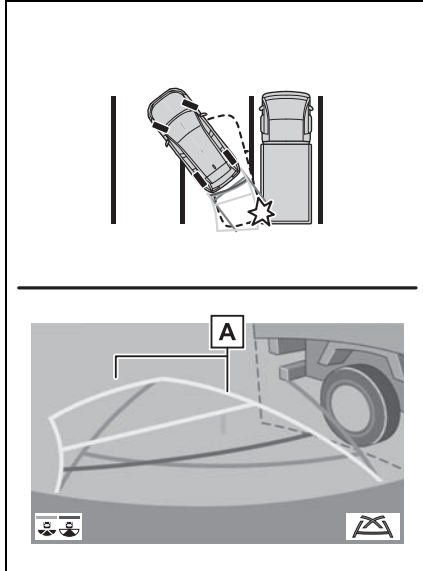

**A** Estimated course lines

■ **Distance guide lines**

Visually check the surroundings and the area behind the vehicle. On the screen, it appears that a truck is parking at point **B**. However, in reality if you back

up to point **A**, you will hit the truck. On the screen, it appears that **A** is closest and **C** is farthest away. However, in reality, the distance to **A** and **C** is the same, and **B** is farther than **A** and **C**.

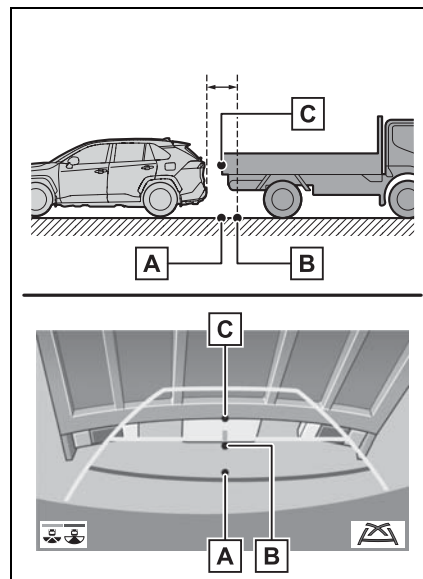

**Things you should know**

**If you notice any symptoms**

If you notice any of the following symptoms, refer to the likely cause and the solution, and re-check.

If the symptom is not resolved by the solution, have the vehicle inspected by your Toyota dealer.

Symptom	Likely cause	Solution
The image is difficult to see	<ul style="list-style-type: none"> <li>• The vehicle is in a dark area</li> <li>• The temperature around the lens is either high or low</li> <li>• The outside temperature is low</li> <li>• There are water droplets on the camera</li> <li>• It is raining or humid</li> <li>• Foreign matter (mud etc.) is adhering to the camera</li> <li>• Sunlight or headlights are shining directly into the camera</li> <li>• The vehicle is under fluorescent lights, sodium lights, mercury lights etc.</li> </ul>	<p>Back up while visually checking the vehicle's surroundings. (Use the monitor again once conditions have been improved.)</p> <p>The procedure for adjusting the picture quality of the parking assist monitor is the same as the procedure for adjusting the screen display. (→P.388)</p>
The image is blurry	Dirt or foreign matter (such as water droplets, snow, mud etc.) is adhering to the camera.	Flush the camera with a large quantity of water and wipe the camera lens clean with a soft and wet cloth.
The image is out of alignment	The camera or surrounding area has received a strong impact.	Have the vehicle inspected by your Toyota dealer.
The guide lines are very far out of alignment	The camera position is out of alignment.	Have the vehicle inspected by your Toyota dealer.
	<ul style="list-style-type: none"> <li>• The vehicle is tilted (there is a heavy load on the vehicle, tire pressure is low due to a tire puncture, etc.)</li> <li>• The vehicle is used on an incline.</li> </ul>	<p>If this happens due to these causes, it does not indicate a malfunction.</p> <p>Back up while visually checking the vehicle's surroundings.</p>

Symptom	Likely cause	Solution
The estimated course lines move even though the steering wheel is straight	There is a malfunction in the signals being output by the steering sensor.	Have the vehicle inspected by your Toyota dealer.
Guide lines are not displayed	The back door is open.	Close the back door. If this does not resolve the symptom, have the vehicle inspected by your Toyota dealer.
The estimated course lines are not displayed	<ul style="list-style-type: none"><li>• Battery has been reinstalled.</li><li>• The steering wheel has been moved while the battery was being reinstalled.</li><li>• Battery power is low.</li><li>• The steering sensor has been reinstalled.</li><li>• There is a malfunction in the signals being output by the steering sensor.</li></ul>	Stop the vehicle, and turn the steering wheel as far as it will go to the left and right. If this does not resolve the symptom, have the vehicle inspected by your Toyota dealer.



**Panoramic view monitor\***

\*: If equipped

**Panoramic view monitor assists the driver in viewing the surroundings, when operating at low speeds, by combining the front, side and rear cameras and displaying a complete vehicle overhead image on the screen.**

**When you press the camera switch or shift the shift lever to the “R” position while the engine switch is in ON, the panoramic view monitor operates.**

**The monitor displays various views of the position and surroundings of the vehicle.**

- The screen illustrations used in this text are intended as examples, and may differ from the image that is actually displayed on the screen.

**Driving precautions**

The panoramic view monitor is a supplemental device intended to assist the driver when checking around the vehicle. When using, be sure to visually check all around the vehicle both directly and using the mirrors before proceeding. If you do not, you

may hit another vehicle or possibly cause an accident.

Pay attention to the following precautions when using the panoramic view monitor.

**⚠ WARNING**

- Never depend on the panoramic view monitor entirely. The image and the position of the guide lines displayed on the screen may differ from the actual state. Use caution just as you would when driving any other vehicle.
- Always make sure to check all around the vehicle with your own eyes when driving.
- Never drive while looking only at the screen as the image on the screen is different from actual conditions. If you are driving while looking only at the screen, you may hit a person or an object, resulting in an accident. When driving, be sure to check the vehicle’s surroundings with your own eyes and the vehicle’s mirrors.
- Depending on the circumstances of the vehicle (number of passengers, amount of luggage, etc.), the position of the guide lines displayed on the screen may change. Be sure to check visually around the vehicle before proceeding.

 **WARNING**

- Do not use the panoramic view monitor system in the following cases:
  - On icy or slick road surfaces, or in snow
  - When using tire chains or emergency tires
  - When the front door or the back door is not closed completely
  - On roads that are not flat or straight, such as curves or slopes
  - If the suspension has been modified or tires of a size other than specified are installed
- In low temperatures, the screen may darken or the image may become faint. The image could distort when the vehicle is moving, or you may become unable to see the image on the screen. Be sure to visually check all around the vehicle both directly and using the mirrors before proceeding.
- If the tire sizes are changed, the position of the guide lines displayed on the screen may change.
- The camera uses a special lens. The distances between objects and pedestrians that appear in the image displayed on the screen will differ from the actual distances. (→P.337)
- When an aftermarket part is installed in the display area of the screen.

 **NOTICE**

- In panoramic view/moving view/see-through view, the system combines images taken from the front, back, left and right side cameras into a single image. There are limits to the range and content that can be displayed. Familiarize yourself with the characteristics of the panoramic view monitor system before using it.
- Image clarity may decline at the four corners of the panoramic view/moving view/see-through view. However, this is not a malfunction, as these are the regions along the border of each camera image where the images are combined.
- Depending on lighting conditions near each of the cameras, bright and dark patches may appear on the panoramic view/moving view/see-through view.
- The panoramic view/moving view/see-through view display does not extend higher than the installation position and image capture range of each camera.
- There are blind spots around the vehicle. Accordingly, there are regions not displayed in panoramic view.
- Three-dimensional objects displayed in wide front view, rear view, wide rear view or side view may not be displayed in panoramic view/moving view/see-through view.

**NOTICE**

- People and other three-dimensional obstacles may appear differently when displayed on the panoramic view monitor. (These differences include, among others, cases in which displayed objects appear to have fallen over, disappear near image processing areas, appear from image processing areas, or when the actual distance to an object differs from the displayed position.)
- When the back door, which is equipped with the back camera, or front doors, which are equipped with door mirrors that have built-in side cameras, are open, images will not be displayed properly on the panoramic view monitor.
- The vehicle icon displayed in panoramic view/moving view/see-through view is a computer generated image. Accordingly, properties such as the color, shape and size will differ from the actual vehicle. For this reason, nearby three-dimensional objects may appear to be touching the vehicle, and actual distances to three-dimensional objects may differ from those displayed.

**Camera switch**

The camera switch is located as shown in the illustration.

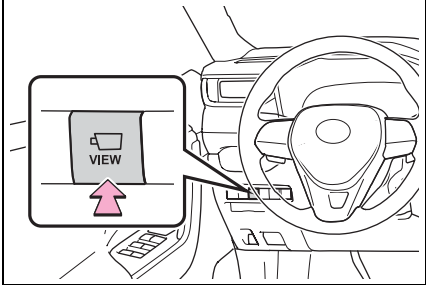

**Display**

**Checking around the vehicle**

► Moving view

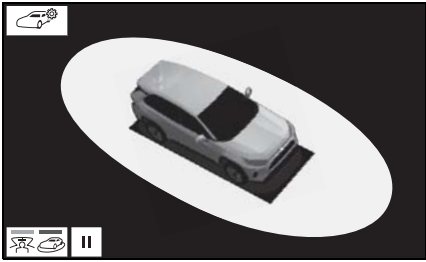

► See-through view

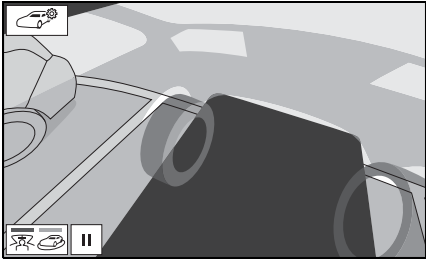

**Checking the front and around the vehicle**

- ▶ Wide front view & panoramic view

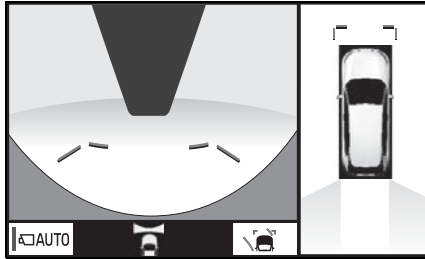

**When folding the outside rear view mirrors**

- ▶ Wide front view & side views



- ▶ Side views

**Checking the rear and around the vehicle**

- ▶ Rear view & panoramic view

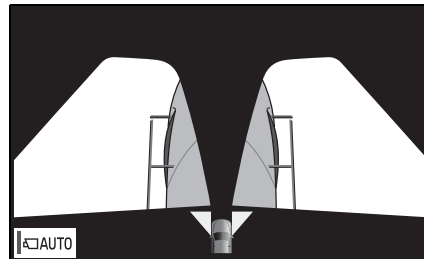
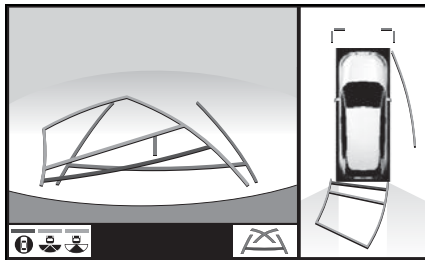

- ▶ Rear view & side views

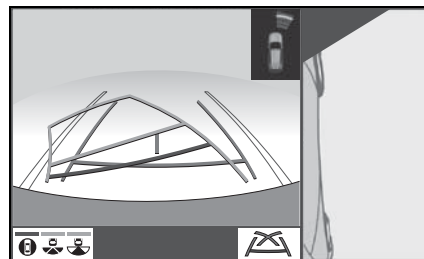

**How to switch the display**

When you press the camera switch or shift the shift lever to the "R" position while the engine switch is in ON, the panoramic view monitor operates.

The monitor displays various views of the position of the vehicle. (The following is an example)

**When the shift lever is in the “P” position**

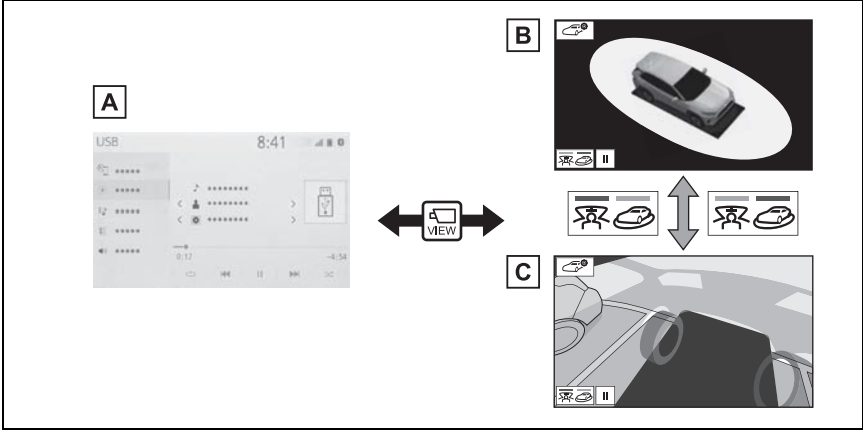

- A** Map screen, audio screen, etc.
- B** Moving view
- C** See-through view

**When the shift lever is in the “D” or “N” position**

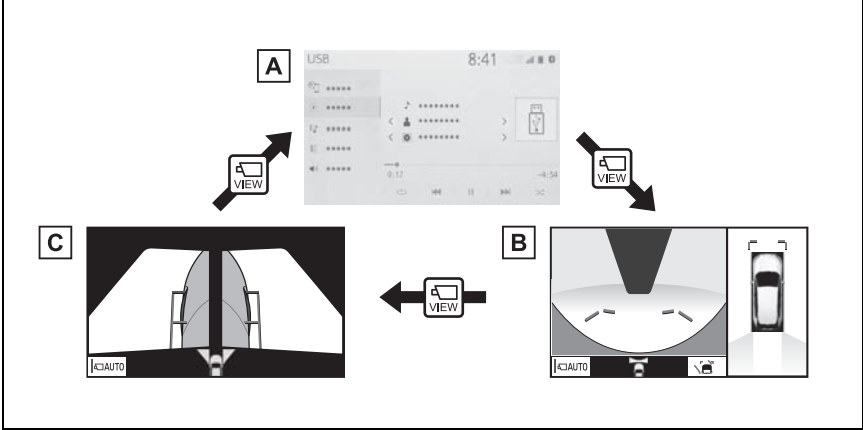

- A** Map screen, audio screen, etc.
- B** Wide front view & panoramic view
- C** Side views

**When the shift lever is in the “R” position**

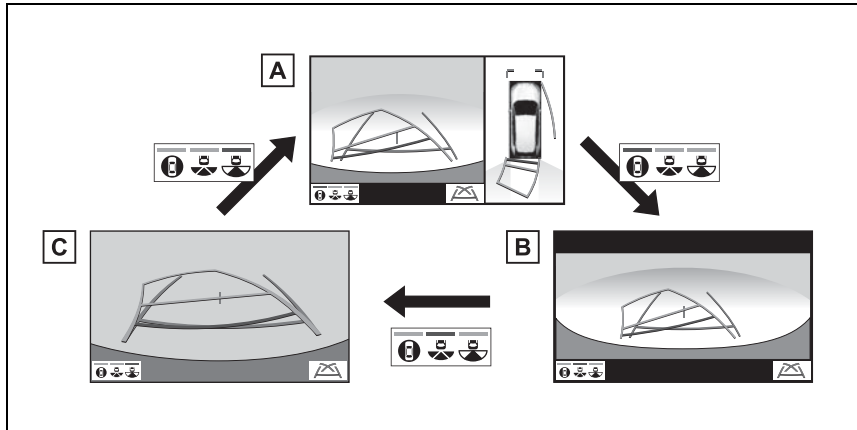

- A** Rear view & panoramic view
- B** Wide rear view
- C** Rear view

**Checking around the vehicle**

The moving view screen and the see-through view screen provide support when checking the areas of around the vehicle while parking. These screens display an image of the vicinity of the vehicle combined from the 4 cameras. The screen will display a 360° view around the vehicle from either inside the vehicle or from a birds-eye view at an angle.

To display the moving view/see-through view screen, press the camera switch when the shift lever is in the “P” position and the intuitive parking assist is

enabled.

**Screen display**

► Moving view

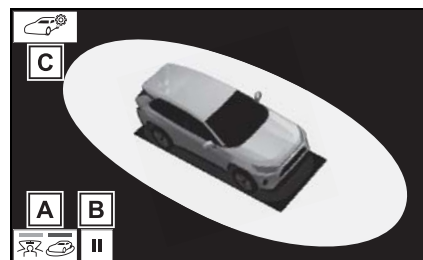

**A** Display mode switching button

Select to change the display mode between the moving view and the see-through view.

**B** Rotation pause switch

Select to pause the rotation of the

screen.

To resume rotation, select .

**C** Body color setting switch

Select to display the body color setting screen and change the color of the vehicle displayed on the panoramic view monitor. (→P.332)

▶ See-through view

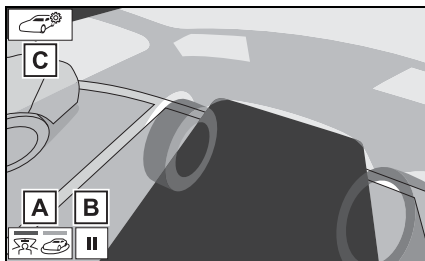

**A** Display mode switching but-

ton

Select to change the display mode between the moving view and the see-through view.

**B** Rotation pause switch

Select to pause the rotation of the screen.

To resume rotation, select .

**C** Body color setting switch

Select to display the body color setting screen and change the color of the vehicle displayed on the panoramic view monitor. (→P.332)

- Pressing the camera switch again changes the screen back to the previously displayed screen, such as the navigation screen.

**Checking the front and around the vehicle**

The wide front view & panoramic view screen provides support when checking the areas in front of the vehicle and around the vehicle when taking-off at T-intersections or other intersections during poor visibility.

To display the screen, press the camera switch when the shift lever is in the “N” or “D” position with the vehicle moving approximately 7 mph (12 km/h) or less.

This screen will be displayed if the intuitive parking assist detects an object in front of your vehicle (intuitive parking assist linked display).

### Screen display

#### ► Wide front view & panoramic view

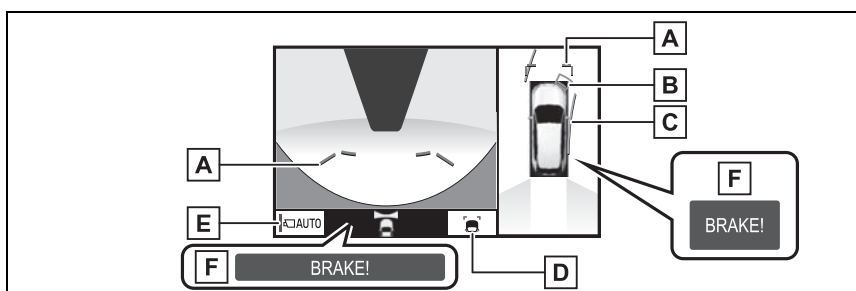

#### **A** Distance guide lines

Shows distance in front of the vehicle.

- Display points approximately 3 ft. (1 m) from the edge of the bumper.

#### **B** Intuitive parking assist

When a sensor detects an obstacle, the direction of and the approximate distance to the obstacle are displayed and the buzzer sounds.

#### **C** Estimated course lines

Shows an estimated course when the steering wheel is turned.

- This line will be displayed when the steering wheel is turned by 90° or more from the center (straight-line) position.

#### **D** Guide line switching button

Select to change the guide line mode between the distance guide line mode and the estimated course line mode. (→P.321)

#### **E** Automatic display button

Select to turn automatic display mode on/off. The indicator on the button illuminates during automatic display mode. (→P.321)

#### **F** Parking Support Brake\*

When the system determines that the possibility of a frontal collision with a detected object is high, a warning message is displayed.

\*: If equipped

- Pressing the camera switch changes the screen to the side views screen or previously displayed screen, such as the navigation screen.
- For details about the intuitive parking assist (→P.270) and Parking Support Brake\* function. (→P.277)
- The display position of the intuitive parking assist and the position of obstacles displayed in the camera image do not match.



\*: If equipped

**⚠ WARNING**

- When a sensor indicator on the intuitive parking assist display illuminates in red or a buzzer sounds continuously, be sure to check the area around the vehicle immediately and do not proceed any further until safety has been ensured, otherwise an unexpected accident may occur.
- As the intuitive parking assist display is displayed over the camera view, it may be difficult to see the intuitive parking assist display depending on the color and brightness of the surrounding area.

**Switching the guide line mode**

Each time the guide line switching button is selected, the mode will change as follows:

- ▶ Distance guide line

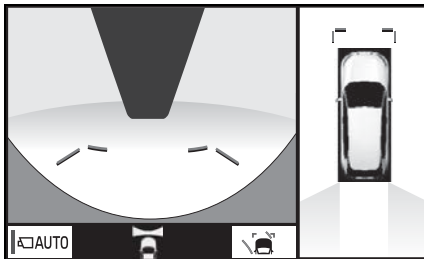

- Only the distance guide lines are displayed.

- ▶ Estimated course line

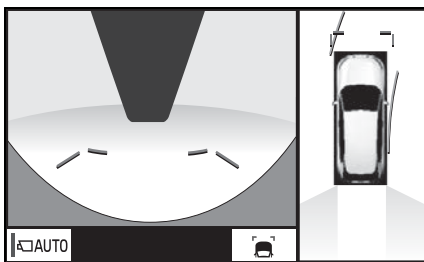

- Estimated course lines will be added to the distance guide lines.

**Automatic display mode**

In addition to screen switching by operating the camera switch, automatic display mode is available. In this mode, the screen is switched automatically in response to vehicle speed.

In automatic display mode, the monitor will automatically display images in the following situations:

- When the shift lever is shifted to "N" or "D" position.
- When vehicle speed is reduced to approximately 6 mph (10 km/h) or less.

**Checking the sides of the vehicle**

The side view screen displays images from the cameras installed on

each outside rear view mirror. This screen is designed to support the driver in safe driving in situations such as when driving on a narrow road, by allowing them to check the areas around the sides of the vehicle.

To display the screen, press the camera switch when the shift lever is in the “D”, or “N” position with the vehicle moving approximately 7 mph (12 km/h) or less.

### Screen display

#### ► Side view

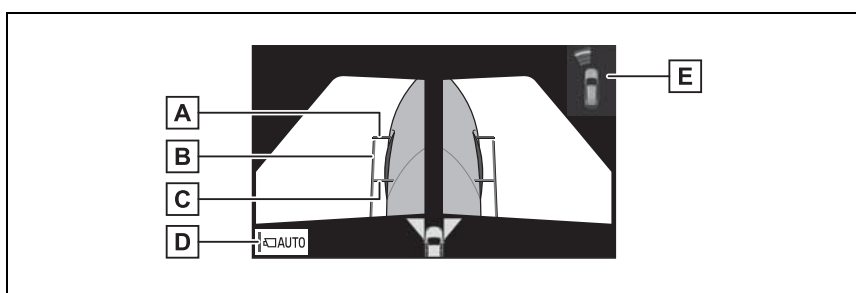

#### **A** Distance guide lines

Show distance in front of the vehicle.

- Display points approximately 3 ft. (1 m) from the edge of the bumper.

#### **B** Vehicle width guide lines

Shows guide lines of the vehicle's width including the outside rear view mirrors.

#### **C** Front tire guide lines

Shows guide lines of where the front tire touches the ground.

#### **D** Automatic display button

Select to turn automatic display mode on/off. The indicator on the button illuminates during automatic display mode. (→P.323)

#### **E** Intuitive parking assist

When a sensor detects an obstacle, the direction of and the approximate distance to the obstacle are displayed and the buzzer sounds.

- Pressing the camera switch changes the screen to the wide front view & panoramic view screen or previously displayed screen, such as the navigation screen.
- For details about the intuitive parking assist. (→P.270)

- The side views can be displayed even when the outside rear view mirrors are retracted.

**⚠ WARNING**

- When a sensor indicator on the intuitive parking assist display illuminates in red or a buzzer sounds continuously, be sure to check the area around the vehicle immediately and do not proceed any further until safety has been ensured, otherwise an unexpected accident may occur.
- As the intuitive parking assist display is displayed over the camera view, it may be difficult to see the intuitive parking assist display depending on the color and brightness of the surrounding area.

**Automatic display mode**

In addition to screen switching by operating the camera switch, automatic display mode is available. In this mode, the screen is switched automatically in response to vehicle speed.

In automatic display mode, the monitor will automatically display images in the following situations:

- When the shift lever is shifted to “N” or “D” position.
- When vehicle speed is reduced to approximately 6 mph (12 km/h) or less.

**Using the vehicle width guide line**

▶ Side View

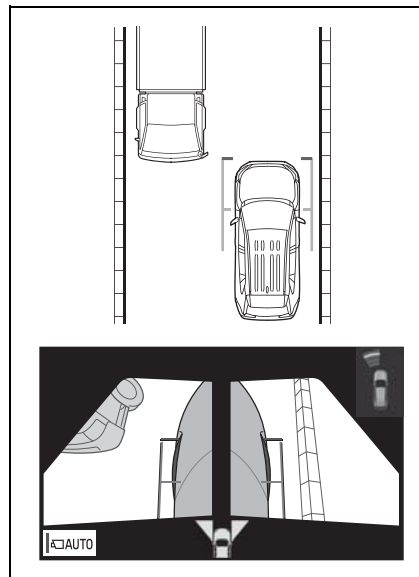

- Check the positions and distance between the vehicle width guide line and a target object such as the obstacle or curb of the road.

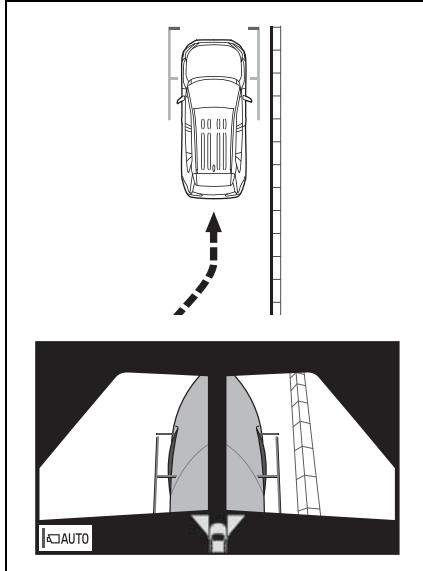

target object.

- Ensure that the vehicle width guide line is parallel to the target object.

- Pull over to the curb as shown in the illustration above, taking care not to let the vehicle width guide line overlap the

### Checking the rear and around the vehicle

The rear view & panoramic view screen, the wide rear view screen and the rear view screen provide support when checking the areas of behind the vehicle and around the vehicle while backing up, for example while parking.

The screens will be displayed when the shift lever is in the “R” position.

### Screen display

Each time the display mode switching button is selected, the mode will change as follows:

► Rear view & panoramic view

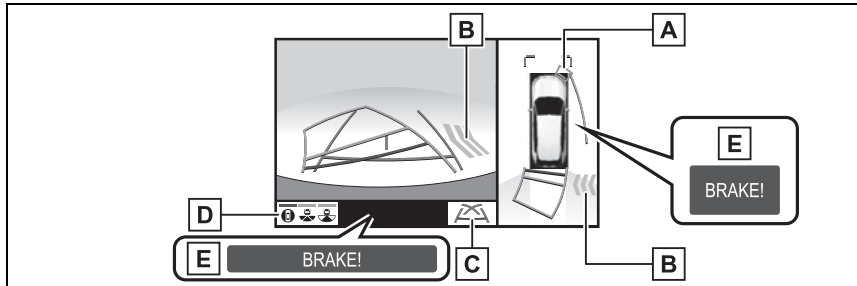

**A** Intuitive parking assist

When a sensor detects an obstacle, the direction of and the approximate distance to the obstacle are displayed and the buzzer sounds.

**B** Rear Cross Traffic Alert

When a sensor detects an obstacle, the direction of obstacle is displayed and the buzzer sounds.

**C** Guide line switching button

Select to switch the guide line mode. (→P.327)

**D** Display mode switching button

Each time the display mode switching button is selected, the mode will change between the rear view & panoramic view mode and the wide rear view & panoramic view mode.

**E** Parking Support Brake \*

When the system determines that the possibility of a collision with a detected object is high, a warning message is displayed.

\*: If equipped

► Wide rear view

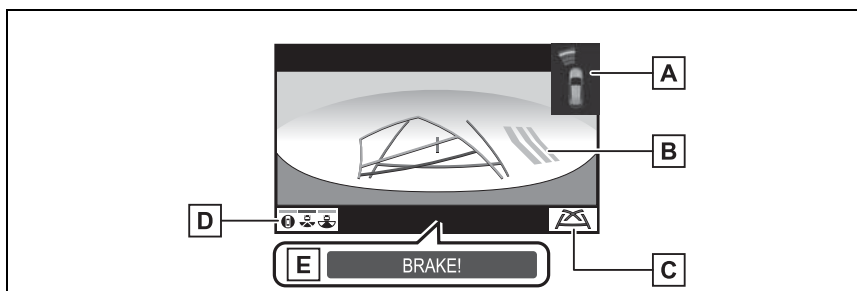

**A** Intuitive parking assist

When a sensor detects an obstacle, the direction of and the approximate

distance to the obstacle are displayed and the buzzer sounds.

**B** Rear Cross Traffic Alert

When a sensor detects an obstacle, the direction of obstacle is displayed and the buzzer sounds.

**C** Guide line switching button

Select to switch the guide line mode. (→P.327)

**D** Display mode switching button

Each time the display mode switching button is selected, the mode will change between the rear view & panoramic view mode and the wide rear view & panoramic view mode.

**E** Parking Support Brake\*

When the system determines that the possibility of a collision with a detected object is high, a warning message is displayed.

\*: If equipped

► Rear view

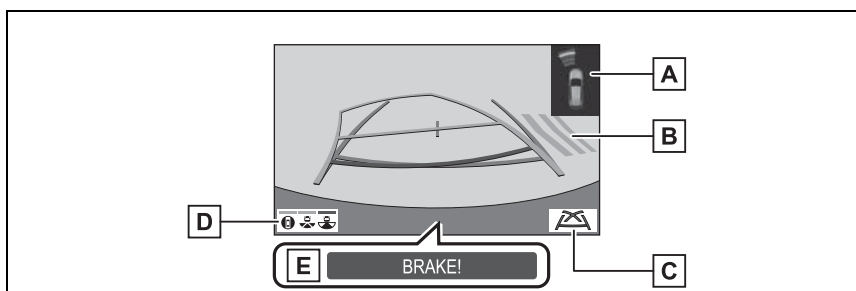

**A** Intuitive parking assist

When a sensor detects an obstacle, the direction of and the approximate distance to the obstacle are displayed and the buzzer sounds.

**B** Rear Cross Traffic Alert

When a sensor detects an obstacle, the direction of obstacle is displayed and the buzzer sounds.

**C** Guide line switching button

Select to switch the guide line mode. (→P.327)

**D** Display mode switching button

Each time the display mode switching button is selected, the mode will change between the rear view & panoramic view mode and the wide rear view & panoramic view mode.

**E** Parking Support Brake\*

When the system determines that the possibility of a collision with a detected object is high, a warning message is displayed.

\*: If equipped

- The monitor is cancelled when the shift lever is shifted into any position other than the "R" position.
- For details about the intuitive parking assist (→P.270), Rear Cross Traffic Alert function (→P.267) and Parking Support Brake\* function. (→P.277)
- The display position of the intuitive parking assist and the position of obstacles displayed in the camera image do not match.

\*: If equipped

**⚠ WARNING**

- When a sensor indicator on the intuitive parking assist display illuminates in red or a buzzer sounds continuously, be sure to check the area around the vehicle immediately and do not proceed any further until safety has been ensured, otherwise an unexpected accident may occur.
- As the intuitive parking assist display and Rear Cross Traffic Alert display are displayed over the camera view, it may be difficult to see the intuitive parking assist display and Rear Cross Traffic Alert display depending on the color and brightness of the surrounding area.

**Guide lines displayed on the screen**

Each time the guide line switching button is selected, the mode will change as follows:

- ▶ Estimated course line

Estimated course lines are displayed which move in accordance with the operation of the steering wheel.

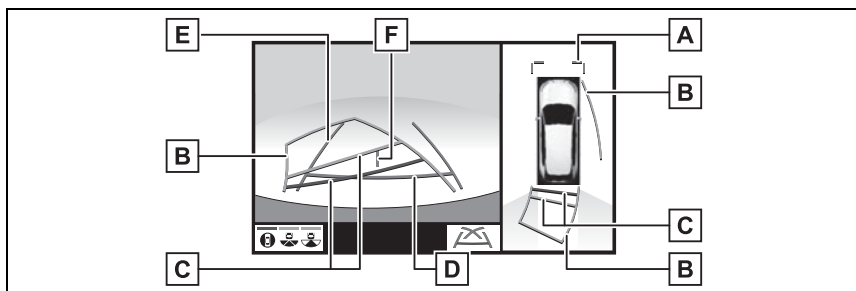

**A Distance guide lines**

Shows distance in front of the vehicle.

- Display points approximately 3 ft. (1 m) from the edge of the bumper.

**B** Estimated course lines

Shows an estimated course when the steering wheel is turned.

**C** Distance guide lines

Shows the distance behind the vehicle when the steering wheel is turned.

- The guide lines move in conjunction with the estimated course lines.
- The guide lines display points approximately 1.5 ft. (0.5 m) (red) and approximately 3 ft. (1 m) (yellow) from the center of the edge of the bumper.

**D** Distance guide line

Shows the distance behind the vehicle.

- Displays a point approximately 1.5 ft. (0.5 m) (blue) from the edge of the bumper.

**E** Vehicle width guide lines

Displays a guide path when the vehicle is being backed straight up.

**F** Vehicle center guide line

Indicates the estimated vehicle center on the ground.

► Parking assist guide line

The steering wheel return points (parking assist guide lines) are displayed.

This mode is recommended for those who are comfortable with parking the vehicle without the aid of the estimated course lines.

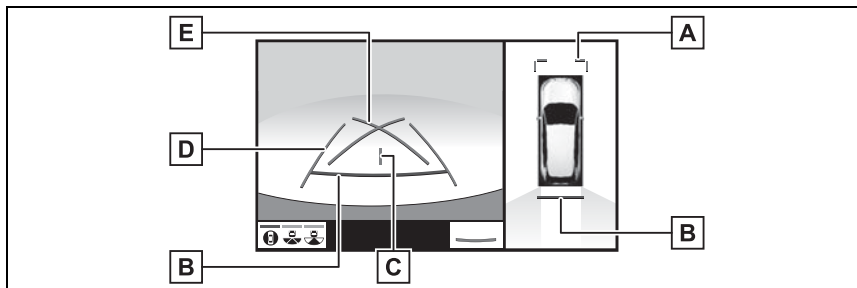

**A** Distance guide lines

Shows distance in front of the vehicle.

- Display points approximately 3 ft. (1 m) from the edge of the bumper.

**B** Distance guide line

Shows the distance behind the vehicle.

- Displays a point approximately 1.5 ft. (0.5 m) (red) from the edge of the bumper.



**C** Vehicle center guide line

Indicates the estimated vehicle center on the ground.

**D** Vehicle width guide lines

Displays a guide path when the vehicle is being backed straight up.

**E** Parking assist guide lines

Shows the path of the smallest turn possible behind the vehicle.

## ▶ Distance guide line

Only distance guide line is displayed.

This mode is recommended for those who are comfortable with parking the vehicle without the aid of the guide lines.

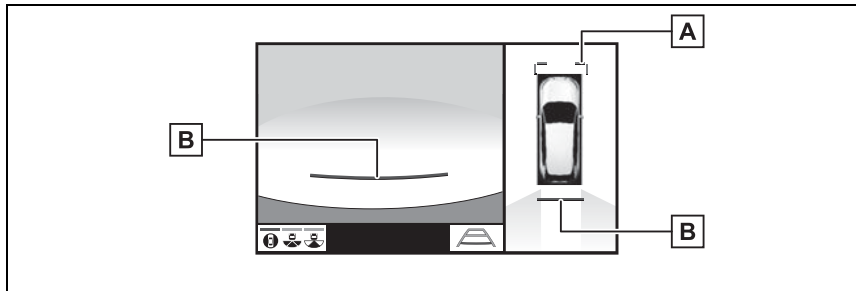
**A** Distance guide lines

Shows distance in front of the vehicle.

- Display points approximately 3 ft. (1 m) from the edge of the bumper.

**B** Distance guide line

Shows the distance behind the vehicle.

- Displays a point approximately 1.5 ft. (0.5 m) (red) from the edge of the bumper.

- The display position of the intuitive parking assist and the position of obstacles displayed in the camera image do not match.

**⚠ WARNING**

- Depending on the circumstances of the vehicle (number of passengers, amount of luggage, etc.), the position of the guide lines displayed on the screen may change. Be sure to check visually around the vehicle before proceeding.
- If the steering wheel is straight and the vehicle width guide lines and the estimated course lines are not in alignment, have the vehicle inspected by your Toyota dealer.

**⚠ WARNING**

● Do not use the system if the display is incorrect due to an uneven (hilly) road or a non-straight (curvy) road.

**Parking**

**Using the estimated course line**

When parking in a space which is in the reverse direction to the space described in the procedure below, the steering directions will be reversed.

- 1 Shift the shift lever to the “R” position.
- 2 Turn the steering wheel so that the estimated course lines are within the parking space, and back up slowly.

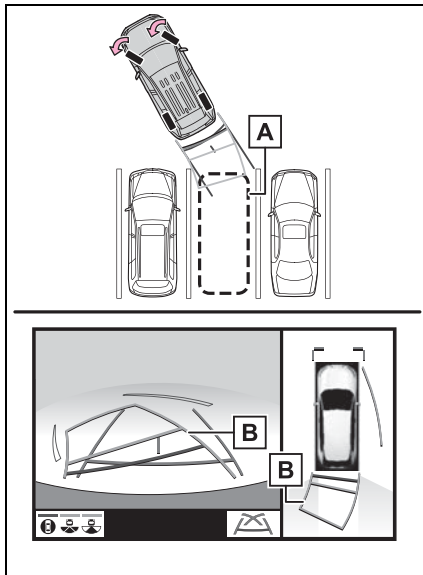

**A** Parking space

**B** Estimated course lines

- 3 When the rear position of the vehicle has entered the parking space, turn the steering wheel so that the vehicle width guide lines are within the left and right dividing lines of the parking space.

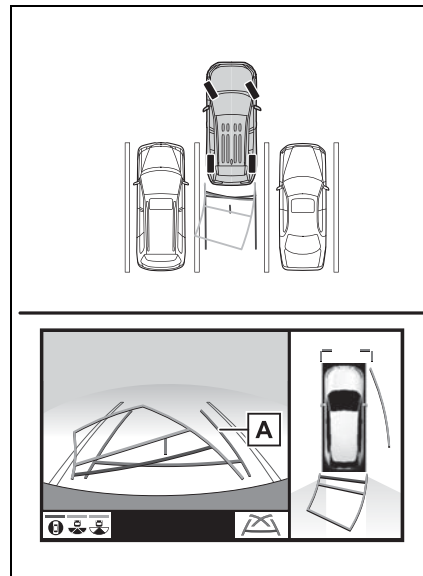

**A** Vehicle width guide line

- 4 Once the vehicle width guide lines and the parking space lines are parallel, straighten the steering wheel and back up slowly until the vehicle has completely entered the parking space.

- 5 Stop the vehicle in an appropriate place, and finish parking.

**Using parking assist guide line**

When parking in a space which is in the reverse direction to the space described in the procedure below, the steering directions will be reversed.

- 1 Shift the shift lever to the “R” position.
- 2 Back up until the parking assist guide line meets the edge of the dividing line of the parking space.
- 3 Turn the steering wheel all the way to the left, and back up slowly.
- 4 Once the vehicle is parallel with the parking space, straighten the steering wheel and back up slowly until the vehicle has completely entered the parking space.
- 5 Stop the vehicle in an appropriate place, and finish parking.

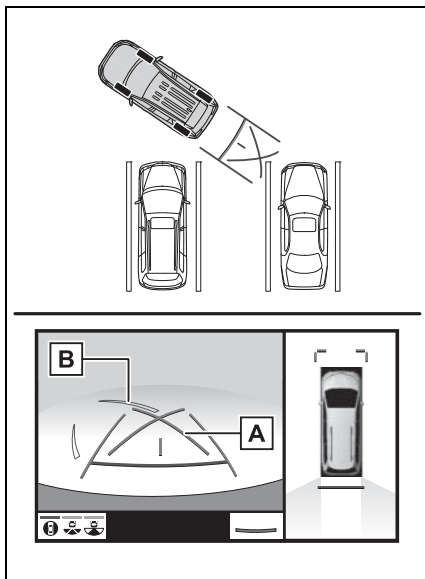

- A** Parking assist guide line
- B** Parking space dividing line

**When folding the outside rear view mirrors**

Even when outside rear view mirrors are stored, the monitor can display various images of the vicinity of the vehicle and assist the operation in the confirming safe conditions in a narrow places, parking, etc.

**Screen display**

- ▶ Wide front view & side views

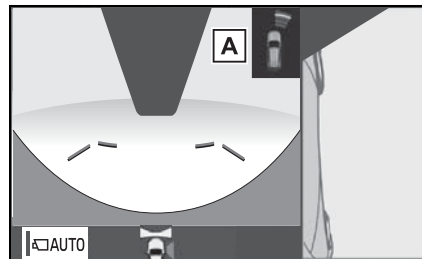

▶ Rear view & side views

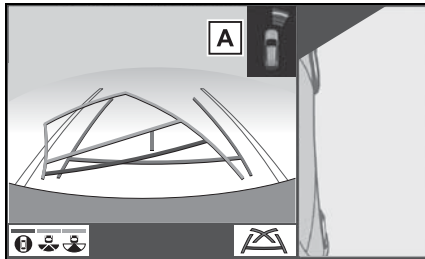

**A** Intuitive parking assist

When a sensor detects an obstacle, the direction of and the approximate distance to the obstacle are displayed and the buzzer sounds.

- For details about the front view and the rear view: →P.319, 324

**⚠ WARNING**

- When a sensor indicator on the intuitive parking assist display illuminates in red or a buzzer sounds continuously, be sure to check the area around the vehicle immediately and do not proceed any further until safety has been ensured, otherwise an unexpected accident may occur.

**Magnifying function**

If displayed objects are too small to see clearly when the panoramic view is displayed, the area around any of the 4 corners of the vehicle can be magnified.

**Magnifying the display**

- 1 Turn the intuitive parking assist on.

- 2 Select the area on the panoramic view display you wish to magnify.

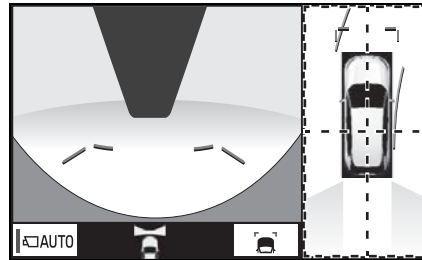

- Touching one of the 4 areas within the dotted lines will magnify that area. (Dotted lines are not displayed on the actual display.)
- To return to the normal view, touch the panoramic view display again.

- The magnifying function is enabled when all of the following conditions are met:
  - The wide front view & panoramic view or the rear view & panoramic view is displayed.
  - The vehicle speed is below approximately 7 mph (12 km/h).
  - The intuitive parking assist is available.
- In the following situations, the magnified display will be canceled automatically:
  - The vehicle speed is approximately 7 mph (12 km/h) or higher.
  - The intuitive parking assist is unavailable.
- When the display is magnified, the guide lines will not be displayed.

**Customizing the panoramic view monitor**

The color of the vehicle dis-

played on the panoramic view monitor can be changed.

3 Select the desired color.

**Changing the body color displayed in the panoramic view monitor**

- 1 Display the moving view/see-through view screen. (→P.318)
- 2 Select .



**A** Displays the next page

**Panoramic view monitor precautions**

**Area displayed on screen**

**Area of image of panoramic view**

The panoramic view monitor displays an image of the surrounding view of the vehicle.

Since the panoramic view processes and displays images based on flat road surfaces, it cannot depict the position of three-dimension objects (such as vehicle bumpers, etc.) that are in positions higher than the surface of the road. Even if there is room between the bumpers of the vehicles and it seems not likely to collide in the image, in reality, the both vehicles are on a collision course.

Check the safety of the surroundings directly.

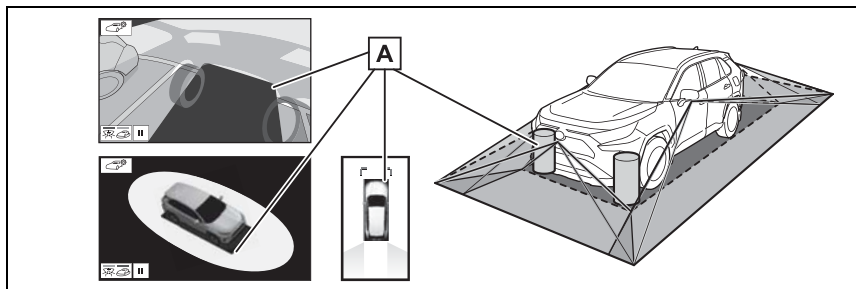

**A** Objects located in the shaded areas will not be displayed on the screen.

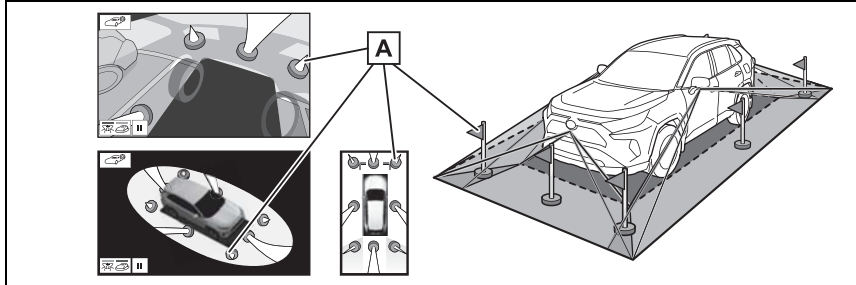

**A** Parts of objects which extend above a certain height cannot be displayed on the screen.

- As the images obtained from four cameras are processed and displayed on the standard of a flat road surface; the panoramic view/moving view/see through view may be displayed as follows.
  - Objects may look collapsed; thinner or bigger than usual.
  - An object with a higher position than the road surface may look farther away than it actually is or may not appear at all.
  - Tall objects may appear protruding from the non-displayed areas of the image.
- Variations in the brightness of the image may appear for every camera.
- The displayed image may be shifted by inclination of the vehicle body, change in vehicle height, etc., depending on the number of passengers, amount of luggage, fuel quantity, etc.
- If the front doors or back door are not completely closed; neither the image nor the guide lines are displayed.
- The position relations of the vehicle icon and the road surface or obstacle may differ from the actual positions.
- The black areas of the vicinity of the vehicle icon are areas that are not captured by the camera.
- Images like the following are combined, thus some areas may be difficult to view.

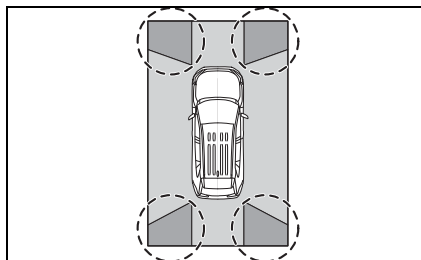

**⚠ WARNING**

● When a sensor indicator on the intuitive parking assist display illuminates in red or a buzzer sounds continuously, be sure to check the area around the vehicle immediately and do not proceed any further until safety has been ensured, otherwise an unexpected accident may occur.

**Area of the image captured by the camera**

▶ Wide front view

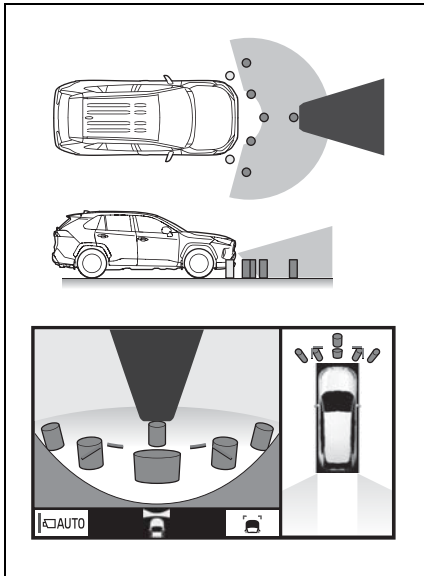

▶ Side view

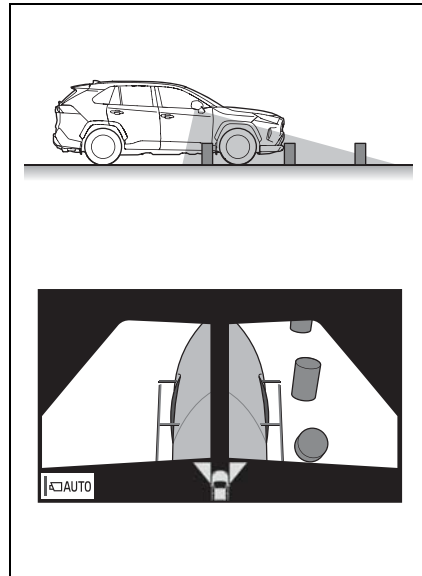

► Rear view

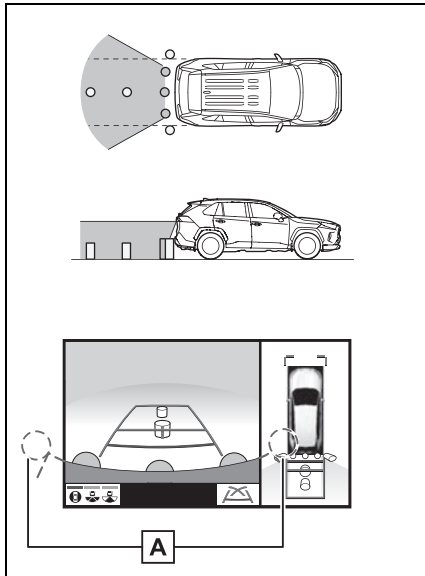

**A** The area around both corners of the bumper will not be displayed.

► Wide rear view

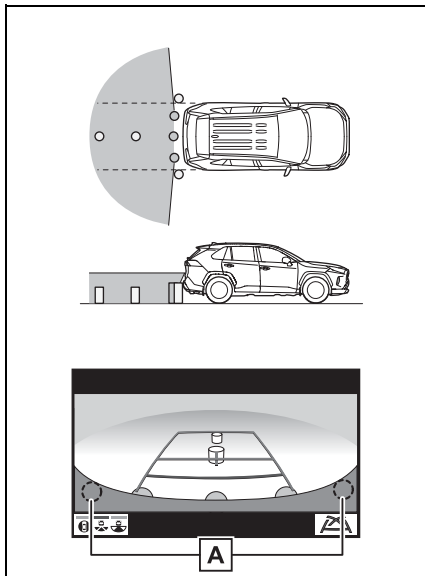

**A** The area around both cor-

ners of the bumper will not be displayed.

- Black masking is done for distance detection differences to the front of the vehicle.
- The area covered by the camera is limited. Objects which are close to either corner of the bumper or under the bumper cannot be seen on the screen.
- The area displayed on the screen may vary depending on vehicle orientation or road conditions.
- The camera uses a special lens. The distance in the image displayed on the screen will differ from the actual distance.

**The camera**

The cameras for the panoramic view monitor are located as shown in the illustrations.

► Front camera

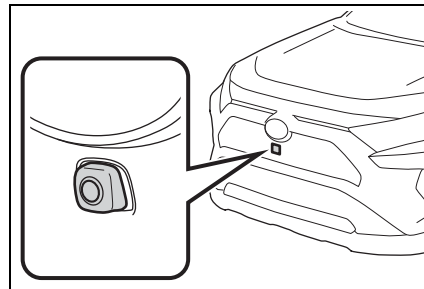

► Side cameras

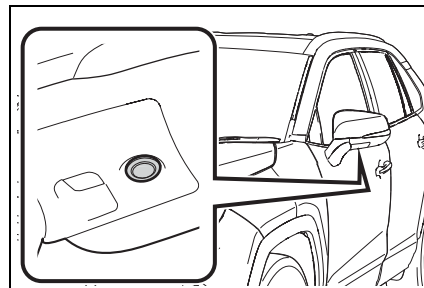

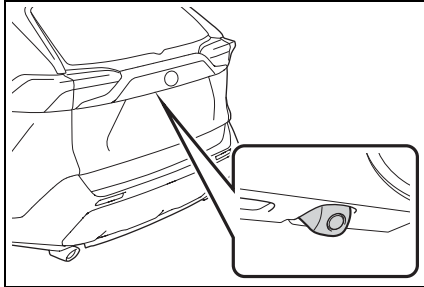

## ► Rear camera

**Using the camera**

If dirt or foreign matter (such as water droplets, snow, mud, etc.) is adhering to the camera, it cannot transmit a clear image. In this case, flush it with a large quantity of water and wipe the camera lens clean with a soft and wet cloth.

 **NOTICE**

- The panoramic view monitor may not operate properly in the following cases.
  - If the camera is hit, the position and mounting angle of the camera may change.
  - As the camera has a water proof construction, do not detach, disassemble or modify it. This may cause incorrect operation.
  - When cleaning the camera lens, flush the camera with a large quantity of water and wipe it with a soft and wet cloth. Strongly rubbing the camera lens may cause the camera lens to be scratched and unable to transmit a clear image.
  - Do not allow an organic solvent, car wax, window cleaner or a glass coating to adhere to the camera. If this happens, wipe it off as soon as possible.
  - If the temperature changes rapidly, such as when hot water is poured on the vehicle in cold weather, the system may not operate normally.
  - When washing the vehicle, do not apply intensive bursts of water to the camera or camera area. Doing so may result in the camera malfunctioning.
- Do not expose the camera to strong impacts as this could cause a malfunction. If this happens, have the vehicle inspected by your Toyota dealer as soon as possible.

**Difference between the screen and the actual road**

- The distance guide lines and the vehicle width guide lines

may not actually be parallel with the dividing lines of the parking space, even when they appear to be so. Be sure to check visually.

- The distances between the vehicle width guide lines and the left and right dividing lines of the parking space may not be equal, even when they appear to be so. Be sure to check visually.
- The distance guide lines give a distance guide for flat road surfaces. In any of the following situations, there is a margin of error between the guide lines on the screen and the actual distance/course on the road.

#### **When the ground behind the vehicle slopes up sharply**

The distance guide lines will appear to be closer to the vehicle than the actual distance. Because of this, objects will appear to be farther away than they actually are. In the same way, there will be a margin of error between the guidelines and the actual distance/course on the road.

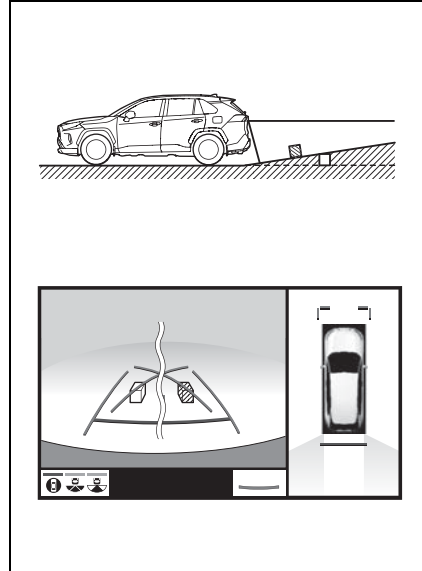

#### **When the ground behind the vehicle slopes down sharply**

The distance guide lines will appear to be farther from the vehicle than the actual distance. Because of this, objects will appear to be closer than they actually are. In the same way, there will be a margin of error between the guidelines and the actual distance/course on the road.

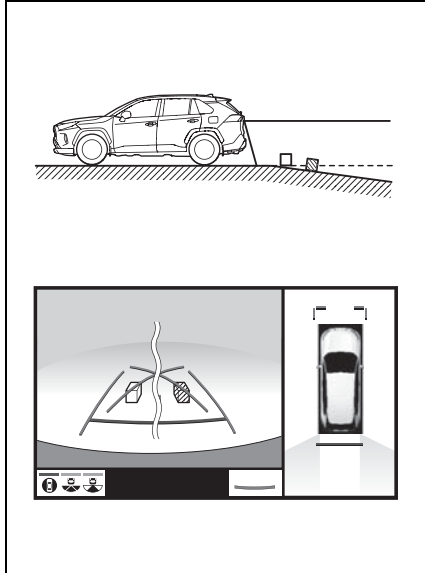

**When any part of the vehicle sags**

When any part of the vehicle sags due to the number of passengers or the distribution of the load, there is a margin of error between the guide lines on the screen and the actual distance/course on the road.

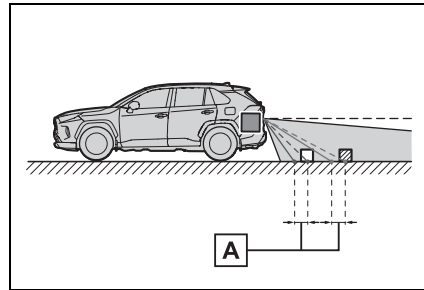

**A** A margin of error

**Distortion of three-dimensional objects on the screen**

When there are three-dimensional objects (such as vehicle bumpers, etc.) nearby in positions higher than the surface of the road, take extra care when using the following.

**Panoramic view display (including magnified display)**

Since the panoramic view processes and displays images based on flat road surfaces, it cannot depict the position of three-dimension objects (such as vehicle bumpers, etc.) that are in positions higher than the surface of the road. For example, even though it appears that there is space between the bumpers of the two vehicles in the illustration below and they are not likely to collide, in reality, a collision is about to occur.

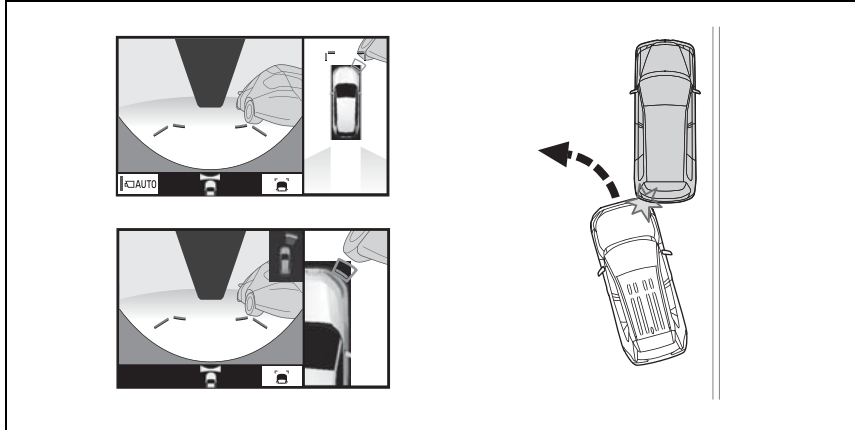

### **⚠ WARNING**

- When a sensor indicator on the intuitive parking assist display illuminates in red or a buzzer sounds continuously, be sure to check the area around the vehicle immediately and do not proceed any further until safety has been ensured, otherwise an unexpected accident may occur.

### **When approaching three-dimensional objects**

The estimated course lines target flat surfaced objects (such as the road). It is not possible to determine the position of three-dimensional objects (such as vehicles) using the estimated course lines and distance guide lines. When approaching a three-dimensional object that extends outward (such as the flatbed of a truck), be careful of the following.

### **⚠ WARNING**

- When a sensor indicator on the intuitive parking assist display illuminates in red or a buzzer sounds continuously, be sure to check the area around the vehicle immediately and do not proceed any further until safety has been ensured, otherwise an unexpected accident may occur.

### **Estimated course lines**

Since the estimated course line is displayed for a flat road surface, it cannot depict the position of three-dimensional objects (such as vehicle bumpers, etc.) that are in positions higher than

the surface of the road. Even if the bumpers of the vehicle is on the outside of the estimated course line in the image, in reality, the vehicles are on a collision course.

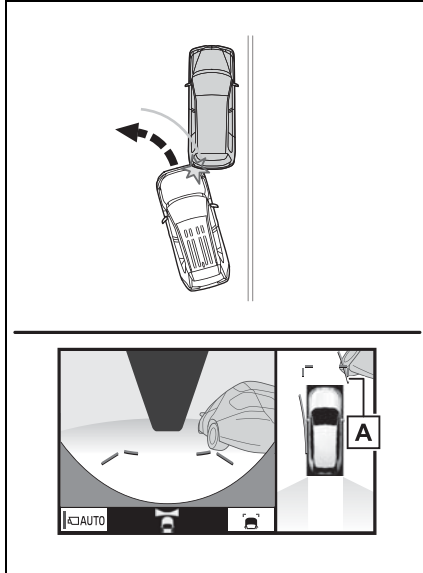

**A** Estimated course line  
 Three-dimensional objects (such as the overhang of a wall or loading platform of a truck) in high positions may not be projected on the screen. Check the safety of the surroundings directly.

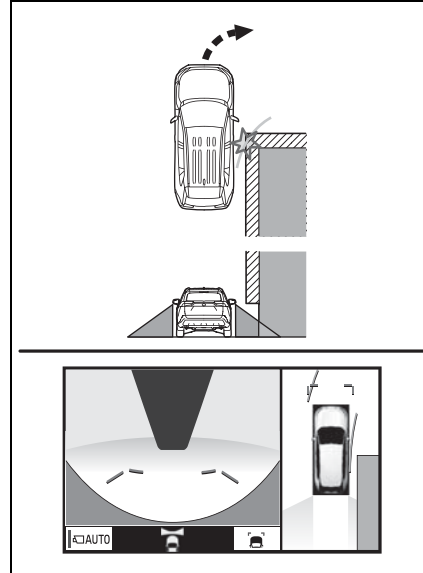

Visually check the surroundings and the area behind the vehicle. In the case shown below, the truck appears to be outside of the estimated course lines and the vehicle does not look as if it hits the truck. However, the rear body of the truck may actually cross over the estimated course lines. In reality if you back up as guided by the estimated course lines, the vehicle may hit the truck.

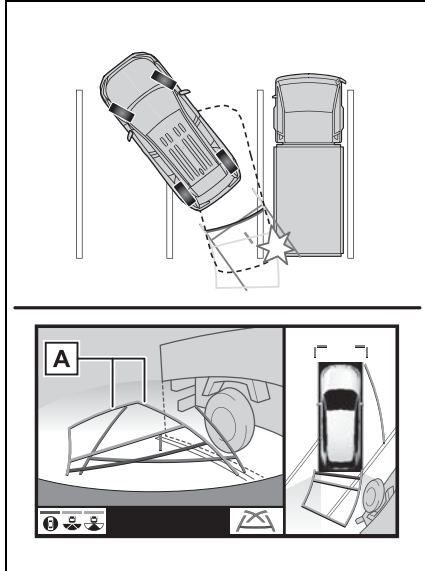

**A** Estimated course lines

**Distance guide lines**

Visually check the surroundings and the area behind the vehicle. On the screen, it appears that a truck is parking at point **B**. However, in reality if you back

up to point **A**, you will hit the truck. On the screen, it appears that **A** is closest and **C** is farthest away. However, in reality, the distance to **A** and **C** is the same, and **B** is farther than **A** and **C**.

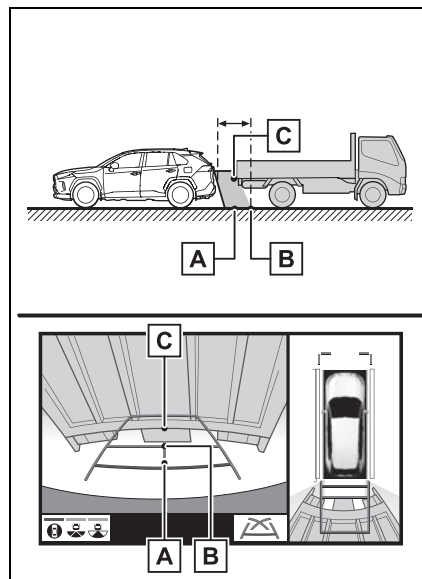

**Things you should know**

**If you notice any symptoms**

If you notice any of the following symptoms, refer to the likely cause and the solution, and re-check.

If the symptom is not resolved by the solution, have the vehicle inspected by your Toyota dealer.

Symptom	Likely cause	Solution
The image is difficult to see	<ul style="list-style-type: none"> <li>• The vehicle is in a dark area</li> <li>• The temperature around the lens is either high or low</li> <li>• The outside temperature is low</li> <li>• There are water droplets on the camera</li> <li>• It is raining or humid</li> <li>• Foreign matter (mud, etc.) is adhering to the camera</li> <li>• Sunlight or headlights are shining directly into the camera</li> <li>• The vehicle is under fluorescent lights, sodium lights, mercury lights, etc.</li> </ul>	<p>Back up while visually checking the vehicle's surroundings. (Use the monitor again once conditions have been improved.)</p> <p>The procedure for adjusting the picture quality of the panoramic view monitor system is the same as the procedure for adjusting the screen display. (→P.388)</p>
The image is blurry	Dirt or foreign matter (such as water droplets, snow, mud, etc.) is adhering to the camera.	Flush the camera with a large quantity of water and wipe the camera lens clean with a soft and wet cloth.
The image is out of alignment	The camera or surrounding area has received a strong impact.	Have the vehicle inspected by your Toyota dealer.
The guide lines are very far out of alignment	The camera position is out of alignment.	Have the vehicle inspected by your Toyota dealer.
	<ul style="list-style-type: none"> <li>• The vehicle is tilted. (There is a heavy load on the vehicle, tire pressure is low due to a tire puncture, etc.)</li> <li>• The vehicle is used on an incline.</li> </ul>	<p>If this happens due to these causes, it does not indicate a malfunction.</p> <p>Back up while visually checking the vehicle's surroundings.</p>

Symptom	Likely cause	Solution
The estimated course lines move even though the steering wheel is straight	There is a malfunction in the signals being output by the steering sensor.	Have the vehicle inspected by your Toyota dealer.
Guide lines are not displayed	The back door is open.	Close the back door. If this does not resolve the symptom, have the vehicle inspected by your Toyota dealer.
The estimated course lines are not displayed	<ul style="list-style-type: none"> <li>• Battery has been reinstalled.</li> <li>• The steering wheel has been moved while the battery was being reinstalled.</li> <li>• Battery power is low.</li> <li>• The steering sensor has been reinstalled.</li> <li>• There is a malfunction in the signals being output by the steering sensor.</li> </ul>	Have the vehicle inspected by your Toyota dealer.
The panoramic view display cannot be magnified	The intuitive parking assist may be malfunctioning or dirty.	Follow the correction procedures for malfunctions of the intuitive parking assist. (→P.270)
The see-through view/moving view cannot be displayed		

### Product license

This product contains eT-Kernel Multi-Core Edition™ real-time OS of eSOL Co.,Ltd.  
 Copyright (c) 2018 eSOL Co.,Ltd.  
 eT-Kernel Multi-Core Edition™ is a trademark of eSOL Co.,Ltd in Japan.

T-Kernel

This Product uses the Source Code of T-Kernel under T-License granted by the Tron Forum (www.tron.org).



**Stop & Start system\***

\*: If equipped

**The Stop & Start system stops and starts the engine according to brake pedal or shift lever operation when the vehicle is stopped, such as at a stoplight, intersection, etc., in order to improve fuel economy and reduce noise pollution caused by the engine idling.**

**Stop & Start system operation**

■ **Stopping the engine**

While driving with the D shift position selected, depress the brake pedal and stop the vehicle. The engine will stop automatically.

When the engine stops, the Stop & Start indicator will illuminate.

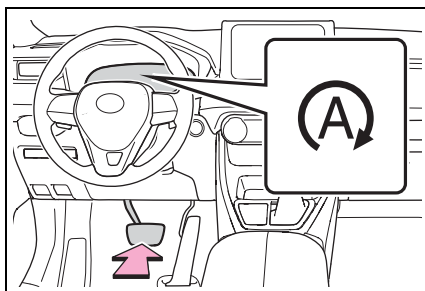

■ **Restarting the engine**

Release the brake pedal. The engine will start automatically.

When the engine starts, the Stop & Start indicator will turn off.

■ **When the brake hold system is operating**

- When the engine is stopped by the Stop & Start system, if the brake pedal is released the engine will remain stopped.
- If the accelerator pedal is depressed while the engine is stopped by the Stop & Start system, the engine will restart.
- While the engine is stopped by the Stop & Start system, if the engine is restarted, the brake hold system will continue to apply the brakes, unless the operation conditions of the brake hold system are no longer met. (→P.206)

■ **When the dynamic radar cruise control with full-speed range is operating**

- When the vehicle is stopped by the dynamic radar cruise control with full-speed range, the engine will stop automatically even though the brake pedal is not depressed.
- When the preceding vehicle starts off, the engine will restart automatically.
- If the engine is restarted by the Stop & Start system while the vehicle is stopped by the dynamic radar cruise control with full-speed range, the vehicle will remain stopped.

### Disabling the Stop & Start system

Press the Stop & Start cancel switch to disable the Stop & Start system.

The Stop & Start cancel indicator will illuminate.

Pressing the switch again will enable the Stop & Start system and the Stop & Start cancel indicator will turn off.

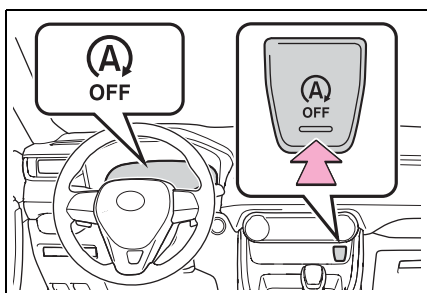

### Automatic enabling of the Stop & Start system

If the Stop & Start system is disabled using the Stop & Start cancel switch, it will be automatically re-enabled once the engine switch is turned off and then the engine is started.

### Hill-start assist control

When the engine is stopped by the Stop & Start system when the vehicle is on an incline, when the brake pedal is released, brake force is temporarily maintained to prevent the vehicle from rolling backwards before the engine is restarted and drive force is generated. When drive force is generated,

the maintained brake force is automatically canceled.

- This function operates on flat surfaces as well as steep inclines.
- Sound may be generated from the brake system, but this does not indicate a malfunction.
- Brake pedal response may change and vibration may occur, but this does not indicate a malfunction.

### Points for use

- If the engine switch is pressed when the engine is stopped by the Stop & Start system, the engine will not be able to be restarted by the automatic engine start function. In this case, restart the engine using the normal engine starting procedure. (→P.193, 194)
- When the engine is being restarted by the Stop & Start system, the power outlets may be temporarily unusable, but this does not indicate a malfunction.
- Installation and removal of electrical components and wireless devices may affect the Stop & Start system. Contact your Toyota dealer for details.
- When stopping the vehicle for a longer period of time, turn the engine switch off to stop the engine completely.
- When the engine is restarted by the Stop & Start system, the steering wheel may temporarily feel heavy.

### Operating conditions

- The Stop & Start system is operational when all of the following conditions are met:

- The vehicle has been driven a certain amount of time.
- The brake pedal is being depressed firmly. (except when the vehicle is stopped by the dynamic radar cruise control with full-speed range when in vehicle-to-vehicle distance control mode)
- The D shift position is selected.
- The driver's seat belt is fastened.
- The driver's door is closed.
- The selected driving mode is normal or Eco drive mode.
- The selected driving mode is not snow mode (AWD models).
- Mud & Sand or Rock & Dirt mode is not selected for Multi-terrain Select (AWD models).
- The windshield defogger is off. (vehicles without a manual air conditioning system)
- The accelerator pedal is not being depressed.
- The engine is adequately warmed up.
- The outside temperature is 23°F (-5°C) or higher.
- The hood is closed. (→P.348)
- In the following situations, the engine may not be stopped by the Stop & Start system. This is not a malfunction of the Stop & Start system.
  - When the air conditioning system is being used.
  - When the battery is undergoing a periodic recharge.
  - When the battery is not sufficiently charged, such as if the vehicle has been parked for a long time and the battery charge has decreased, the electric load is large, the battery fluid temperature is excessively low or the battery has deteriorated.
  - When the brake booster vacuum is low.
  - When the elapsed time since the engine was restarted is short.
  - When the vehicle is stopped frequently, such as when in a traffic jam.
  - When the engine coolant temperature or transmission fluid temperature is extremely low or high.
- When the vehicle is stopped on a steep incline.
- When the steering wheel is being operated.
- When the vehicle is being driven in a high altitude area.
- When the battery fluid temperature is extremely low or high.
- For a while after the battery terminals have been disconnected and reconnected.
- When the engine is stopped by the Stop & Start system, the engine will be restarted automatically if any of the following conditions are met: (To enable the engine to be stopped by the Stop & Start system again, drive the vehicle.)
  - The air conditioning system is turned on. (vehicles without a manual air conditioning system)
  - The windshield defogger is turned on. (vehicles without a manual air conditioning system)
  - The shift lever is shifted from D.
  - The driver's seat belt is unfastened.
  - The driver's door is opened.
  - The driving mode is changed from normal or Eco drive mode to another mode.
  - The driving mode is changed to snow mode (AWD models).
  - Mud & Sand or Rock & Dirt mode is selected for Multi-terrain Select (AWD models).
  - The Stop & Start cancel switch is pressed.
  - The steering wheel is operated.
  - The accelerator pedal is depressed.
  - The vehicle starts to roll on an incline.
- When the engine is stopped by the Stop & Start system, the engine may restart automatically in the following situations: (To enable the engine to be stopped by the Stop & Start system again, drive the vehicle.)
  - When the brake pedal is pumped

or strongly depressed.

- When the air conditioning system is being used.
- When a switch of the air conditioning system is operated (windshield defogger switch, etc.).
- If the battery charge becomes low.

#### ■ When the hood is opened

- If the hood is opened while the engine is stopped by the Stop & Start system, the engine will stall and will not be able to be restarted by the automatic engine start function. In this case, restart the engine using the normal engine starting procedure. (→P.193, 194)
- If the hood is closed after the engine is started with the hood open, the Stop & Start system will not operate. Close the hood, turn the engine switch off, wait 30 seconds or more, and then start the engine.

#### ■ Air conditioning system operation while the engine is stopped by the Stop & Start system

Vehicles with an automatic air conditioning system: When the air conditioning is in automatic mode and the engine is stopped by the Stop & Start system, the fan may operate at a low speed in order to prevent the temperature in the cabin from increasing or decreasing or may be stopped.

To prioritize air conditioning system performance when the vehicle is stopped, disable the Stop & Start system by pressing the Stop & Start cancel switch.

- If the windshield is fogged up  
Turn the windshield defogger on. (→P.511, 517)  
If the windshield fogs up frequently, press the Stop & Start cancel switch to disable the Stop & Start system.
- If an odor is emitted from the air conditioning system
  - Vehicles with a manual air condi-

tioning system:

If the idling stop time setting is set to “Extended”, change it to “Standard”. If an odor is emitted when the idling stop time setting is set to “Standard”, press the Stop & Start cancel switch to deactivate the Stop & Start system.

- Vehicles with an automatic air conditioning system:  
Press the Stop & Start cancel switch to deactivate the Stop & Start system.

#### ■ Changing the idling stop time with the air conditioning system on

The length of time the Stop & Start system will operate when the air conditioning system is on can be changed in  of the multi-information display (→P.94). (The length of time the Stop & Start system will operate when the air conditioning system is off cannot be changed.)

#### ■ Displaying the Stop & Start system status

After Start:

Displays the cumulative time that the engine is stopped by the Stop & Start system from when the engine is started until the engine is stopped.

This item is reset each time the engine stops.

#### ■ Multi-information display messages

If the following situations, 

and a message may be displayed on the multi-information display.

- When the engine cannot be stopped by the Stop & Start system

 “Press Brake More to Activate”

- The brake pedal is not sufficiently depressed.

→ If the brake pedal is depressed further, the system will operate.

 “Non-Dedicated Battery”

- A battery not designed for use with a Stop & Start system may have been installed.

→ Have the vehicle inspected by your Toyota dealer.

 “Battery Charging”

- The battery charge may be low.  
→ Stopping of the engine is temporarily prohibited to prioritize charging of the battery. After the engine runs for a certain amount of time, the system will be enabled.

- A refresh charge may be occurring (Examples: For a while after the battery terminals have been disconnected and reconnected. For a while after the battery has been replaced. etc.)

→ After a refresh charge for up to an hour completes, the system can be operated.

- If displayed continuously for a long time (more than an hour)  
→ The battery may be deteriorated. Contact your Toyota dealer for details.

 “Stop & Start System

Unavailable”

- The Stop & Start system is temporarily disabled.

→ Allow the engine to run for some time.

- The engine may have been started with the hood open.

→ Close the hood, turn the engine

switch off, wait for 30 seconds or more, and then start the engine.

 “In Preparation”

- The vehicle is being driven in a high altitude area.
- The brake booster vacuum is low.

→ When the brake booster vacuum reaches a predetermined level, the system will be enabled.

 “For Climate Control”

- The air conditioning system is being used when the ambient temperature is high or low.

→ If the difference between the set temperature and cabin temperature becomes small, the system will be enabled.

- The windshield defogger is on.

- When the engine automatically restarts while stopped by the Stop & Start system

 “In Preparation”

- The brake pedal has been depressed further or pumped.

→ The system will be enabled after the engine runs and the brake booster vacuum reaches a predetermined level.

 “For Climate Control”

- The air conditioning system has been turned on or is being used.
- The windshield defogger has been turned on.

 “Battery Charging”

- The battery charge may be low.

→ The system will be enabled after the engine runs to sufficiently

charge the battery.

#### ■ When the buzzer sounds

If the driver's door is opened when the engine is stopped by the Stop & Start system and the shift lever is in D, a buzzer will sound and the Stop & Start system indicator will flash. To stop the buzzer, close the driver's door.

#### ■ The Stop & Start system protection function

- When the volume of the audio system is excessively high, sound output from the audio system may suddenly be cut off in order to reduce battery consumption. To prevent the audio system from being cut off, keep the volume of audio system at a moderate level. If the audio system has been cut off, turn the engine switch off, wait for 3 seconds or more and then turn it to ACC or ON to re-enable the audio system.
- The audio system may not be activated if the battery terminals are disconnected and then reconnected. If this occurs, turn the engine switch off and then repeat the following operation twice to activate the audio system normally.
  - Turn the engine switch to ON and then to off.

#### ■ Replacing the battery

→P.657

#### ■ If the Stop & Start cancel indicator flashes continuously

The system may be malfunctioning. Have the vehicle inspected by your Toyota dealer.

#### ■ If "Stop & Start System Malfunction Visit Your Dealer" is displayed on the multi-information display

The system may be malfunctioning. Have the vehicle inspected by your Toyota dealer.

### WARNING

#### ■ When the Stop & Start system is operating

Make sure to disable the Stop & Start system while the vehicle is in a poorly ventilated area.

If not disabled, the engine may be automatically restarted unexpectedly, causing exhaust gases to collect and enter the vehicle, possibly resulting in death or a serious health hazard.

- Do not leave the vehicle while the engine is stopped by the Stop & Start system (while the Stop & Start indicator is on). An accident may occur due to the automatic engine start function.
- Depress the brake pedal and apply the parking brake when necessary while the engine is stopped by the Stop & Start system (while the Stop & Start indicator is on).

### NOTICE

#### ■ To ensure the system operates correctly

If any of the following situations occur, the Stop & Start system may not operate correctly. Have your vehicle inspected by your Toyota dealer.

- While the driver's seat belt is fastened, the driver's and front passenger's seat belt reminder light flashes.
- Even though the driver's seat belt is not fastened, the driver's and front passenger's seat belt reminder light does not illuminate.

 NOTICE

- Even though the driver's door is closed, the open door warning light is illuminated or the interior light is illuminated when the interior light switch is in the door position.
- Even though the driver's door is open, the open door warning light does not illuminate or the interior light does not illuminate when the interior light switch is in the door position.

### Driving mode select switch

The driving modes can be selected to suit the driving and usage conditions.

### Selecting a driving mode

- FF vehicles/Dynamic Torque Control AWD vehicles

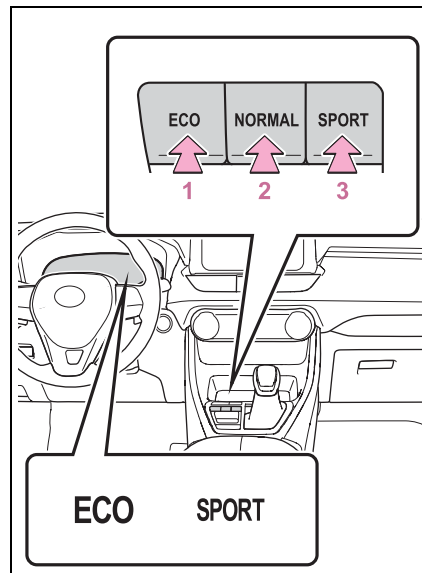

#### 1 Eco drive mode

Suitable for driving to improve fuel economy by more smoothly generating torque in response to accelerator pedal operations compared to normal mode and restraining air conditioning system operations (heating/cooling).

When the switch is pressed while not in Eco drive mode, the system switches to Eco drive mode and the

Eco drive mode indicator illuminates on the multi-information display.

### 2 Normal mode

Suitable for normal driving.

The driving mode returns to normal mode if the switch is pressed while in Eco drive mode or sport mode.

### 3 Sport mode

Controls the steering feeling and engine to create an acceleration response that is suitable for sporty driving. Suitable for when crisp handling is desired, such as when driving on mountainous roads.

When the switch is pressed while not in sport mode, the system switches to sport mode and the sport mode indicator illuminates on the multi-information display.

## ■ Dynamic Torque Vectoring AWD vehicles

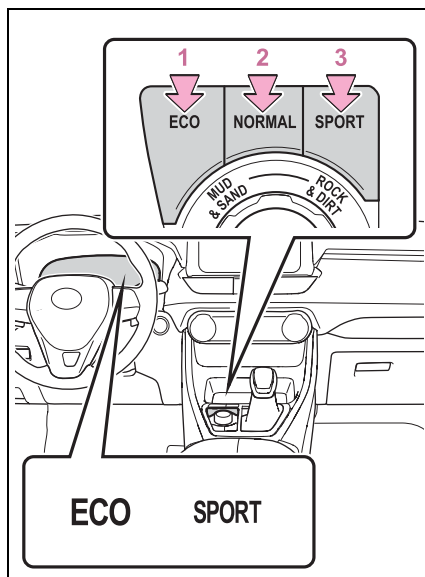

### 1 Eco drive mode

Suitable for driving to improve fuel

economy by more smoothly generating torque in response to accelerator pedal operations compared to normal mode and restraining air conditioning system operations (heating/cooling).

When the switch is pressed while not in Eco drive mode, the system switches to Eco drive mode and the Eco drive mode indicator illuminates on the multi-information display.

### 2 Normal mode

Suitable for normal driving.

The driving mode returns to normal mode if the switch is pressed while in Eco drive mode or sport mode.

### 3 Sport mode

Controls the steering feeling and engine to create an acceleration response that is suitable for sporty driving. Suitable for when crisp handling is desired, such as when driving on mountainous roads.

When the switch is pressed while not in sport mode, the system switches to sport mode and the sport mode indicator illuminates on the multi-information display.

## ■ When changing to a driving mode other than normal mode

- The background color of the multi-information display changes according to the selected driving mode.
- When the speedometer is set to analog display, the speedometer display color also changes. (For vehicles with the 7-inch multi-information display only)
- Switches to AWD control suitable for the selected mode. (For Dynamic Torque Vectoring AWD vehicles only)



#### ■ Air conditioning system operation in Eco drive mode

In Eco drive mode, heating/cooling operations and the fan speed is controlled to improve fuel efficiency. Perform the following procedures to increase the air conditioning performance.

- Vehicles with automatic air conditioning system: Turn eco air conditioning mode off (→P.516)
- Adjust the fan speed (→P.510, 516)
- Cancel Eco drive mode

#### ■ Canceling a driving mode

- Sport mode is automatically canceled and the driving mode returns to normal mode when the engine switch is turned off.
- Normal mode and Eco drive mode are not canceled until another driving mode is selected. (Even if the engine switch is turned off, normal mode and Eco drive mode will not be automatically canceled.)

### Multi-terrain Select (AWD vehicles)

**When driving over muddy, sandy or rough road surfaces, Multi-terrain Select selects a suitable driving mode to switch AWD, brake and drive force control to perform control suitable for the road condition.**

#### WARNING

##### ■ Before using Multi-terrain Select

Make sure to observe the following precautions. Failure to observe these precautions may result in an unexpected accident.

- Check that the Mud & Sand and Rock & Dirt indicators are illuminated before driving. Multi-terrain Select will not operate when the indicators are off.
- Do not rely solely upon the Multi-terrain Select. This function is not intended to expand the limits of the vehicle. If the system is continuously used for a long period of time, the load on related parts increases and the system may be unable to operate normally, which may lead to an accident. Thoroughly check the road conditions and driving route before driving, and drive with caution.

**⚠ WARNING**

- The road conditions listed in “Guidelines for selecting each mode” are for reference only. There is a chance that the function may not be the most appropriate in terms of road conditions such as pitch, slipperiness, undulation, etc. Thoroughly check the road conditions before driving.

**Guidelines for selecting each mode**

Control that is suitable for the following road conditions can be performed by switching to either of the two modes. Select a mode that is appropriate for the road condition.

**■ Mud & Sand mode**

Suitable for driving on roads with increased driving resistance such as sandy roads, muddy roads, etc.

**■ Rock & Dirt mode**

Suitable for driving in bumpy road conditions, such as on unpaved forest roads.

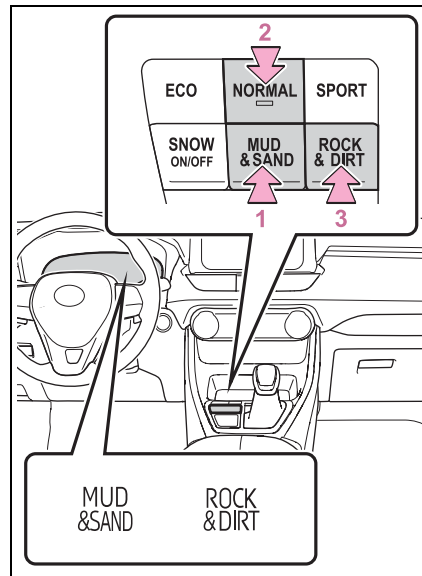
**Changing the mode****■ Dynamic Torque Control AWD vehicles****1 Mud & Sand mode**

When the switch is pressed while not in Mud & Sand mode, the system switches to Mud & Sand mode and the Mud & Sand mode indicator, VSC OFF indicator (→P.79) and PCS warning light (→P.77) illuminate on the multi-information display or the instrument cluster.

**2 Normal mode**

Mode that performs AWD, brake and drive force control suitable for driving on general roads. Use normal mode when not driving off-road.

The driving mode returns to normal mode if the switch is pressed while in Mud & Sand mode or Rock & Dirt mode.

**3 Rock & Dirt mode**

When the switch is pressed while not in Rock & Dirt mode, the system switches to Rock & Dirt mode and the Rock & Dirt mode indicator illuminates on the multi-information display.

■ **Dynamic Torque Vectoring AWD vehicles**

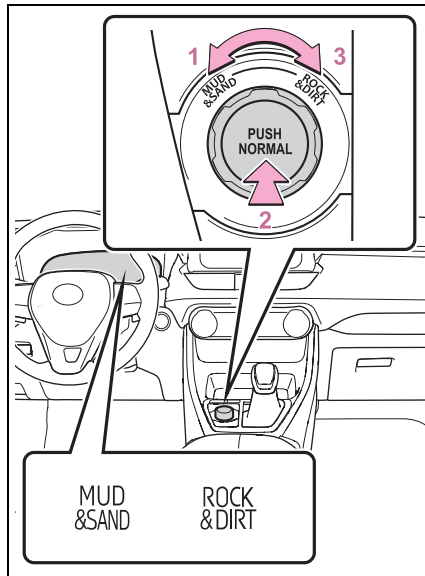

1 **Mud & Sand mode**

When the switch is turned to the left while not in Mud & Sand mode, the system switches to Mud & Sand mode and the Mud & Sand mode indicator, VSC OFF indicator (→P.79) and PCS warning light (→P.77) illuminate on the multi-information display or the instrument cluster.

2 **Normal mode**

Mode that performs AWD, brake and drive force control suitable for driving on general roads. Use normal mode when not driving off-road.

The driving mode returns to normal

mode if the switch is pressed while in Mud & Sand mode or Rock & Dirt mode.

3 **Rock & Dirt mode**

When the switch is turned to the right while not in Rock & Dirt mode, the system switches to Rock & Dirt mode and the Rock & Dirt mode indicator illuminates on the multi-information display.

■ **Multi-terrain Select**

- Multi-terrain Select is intended for use when driving on rough roads. Drive in normal mode during normal driving.
- The Mud & Sand and Rock & Dirt modes control the vehicle so that it can maximize the drive force and improve drivability on rough roads. As a result, fuel efficiency may diminish when compared to driving in normal mode.

■ **If Mud & Sand or Rock & Dirt mode is selected**

- The background of the multi-information display will change following the Multi-terrain Select mode.
- The AWD operation status display will automatically switch on the multi-information display.
- The color of the switch will change following the Multi-terrain Select mode. (For Dynamic Torque Vectoring AWD vehicles only)

■ **AWD control for Mud & Sand and Rock & Dirt modes**

If the vehicle speed exceeds the speeds listed below, 4WD control is performed similar to that performed in Normal mode, even if Mud & Sand or Rock & Dirt mode is selected.

- Mud & Sand mode: Vehicle speed is approximately 40 km/h (25 mph) or more
- Rock & Dirt mode: Vehicle speed

is approximately 25 km/h (16 mph) or more

If the vehicle speed drops below the above speeds, the system automatically switches to the 4WD control suitable for each mode.

#### ■ When Multi-terrain Select brake control temporarily stops operating

If Mud & Sand or Rock & Dirt mode is continuously used for a long period of time, the brakes may overheat, and Multi-terrain Select brake control may temporarily stop operating.

- At this time, the buzzer sounds intermittently and “Traction Control Turned OFF” is displayed on the multi-information display.
- If Multi-terrain Select brake control stops operating, stop the vehicle in a safe location as soon as possible\* and wait until the system temperature decreases. Once the display message on the multi-information display turns off, the brake control returns to normal. Note that normal driving is still possible even when Multi-terrain Select brake control is not operating.

\*: After stopping the vehicle, do not stop the engine until the display message has turned off.

#### ■ When Mud & Sand or Rock & Dirt mode is canceled

In the following situations, Mud & Sand mode or Rock & Dirt mode are automatically canceled even if they are selected.

- When the driving mode is changed (→P.351)
- When the engine switch is turned off

#### ■ Driving in Mud & Sand or Rock & Dirt mode

The following types of situations may occur, but they are not malfunc-

tions.

- Vibrations may be felt throughout the vehicle or steering wheel
- Operating noise may be heard from the engine compartment

#### ■ When an inspection at your Toyota dealer is necessary

In the following situations, the system may be malfunctioning. Have the vehicle inspected by your Toyota dealer immediately.

- When the slip indicator light illuminates while Mud & Sand or Rock & Dirt mode is selected
- When the indicator for each mode does not illuminate even though Mud & Sand or Rock & Dirt mode is selected

**Snow mode switch (AWD vehicles)**

**Snow mode can be selected to suit the conditions when driving on slippery road surfaces, such as on snow.**

**System operation**

■ **Dynamic Torque Control AWD vehicles**

Press the snow mode switch.

When the switch is pressed, the system switches to snow mode and the snow mode indicator illuminates on the multi-information display.

When the switch is pressed again, the snow mode indicator turns off.

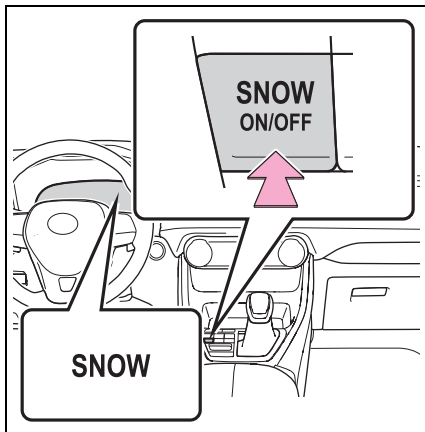

■ **Dynamic Torque Vectoring AWD vehicles**

Press the snow mode switch.

When the switch is pressed, the system switches to snow mode and the snow mode indicator illuminates on the multi-information display.

When the switch is pressed again, the snow mode indicator turns off.

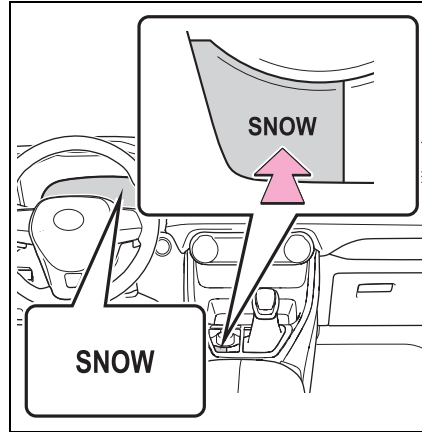

■ **When changing to snow mode**

The background of the multi-information display changes.

■ **Canceling the snow mode**

Snow mode is automatically canceled when the engine switch is turned off or Mud & Sand or Rock & Dirt mode is selected for Multi-terrain Select.

## Downhill assist control system\*

\*: If equipped

**The downhill assist control system helps to prevent excessive speed on steep downhill slopes.**

**The system will operate when the vehicle is traveling under 25 km/h (15 mph) with the accelerator and brake pedals released.**

### WARNING

#### ■ When using downhill assist control system

Do not rely overmuch on the downhill assist control system. This function does not extend the vehicle's performance limitations. Always thoroughly check the road conditions, and drive safely.

### System operation

Press the "DAC" switch.

The downhill assist control system indicator will come on and the system will operate.

When the system is in operation, the slip indicator light will flash, and the stop lights/high mounted stop lights will be lit. A sound may also occur during the operation. This does not indicate a malfunction.



### Turning off the system

Press the "DAC" switch while the system is in operation.

The downhill assist control system indicator will flash as the system gradually ceases operation, and will turn off when the system is fully off. Press the "DAC" switch while the downhill assist control system indicator is flashing to start the system again.

### ■ Operating tips

The system will operate when the shift lever is in D or 1 range of S mode or R.

#### ■ If the downhill assist control system indicator flashes

- In the following situations, the indicator flashes and the system will not operate:
  - The shift lever is in a position other than D or 1 range of S mode or R.
  - The accelerator or brake pedal is depressed.
  - The vehicle speed exceeds approximately 15 mph (25 km/h).
  - The brake system overheats.
- In the following situation, the indicator flashes to alert the driver, but the system will operate:
  - The "DAC" switch is turned off while the system is operating.

The system will gradually ceases

operation. The indicator will flash during operation, and then go off when the system is fully off.

■ **When the downhill assist control system is operated continuously**

This may cause the brake actuator to overheat. In this case, the downhill assist control system will stop operating, a buzzer will sound and the downhill assist control system indicator will start flashing. Refrain from using the system until the downhill assist control system indicator stays on. (The vehicle can be driven normally during this time.)

■ **Sounds and vibrations caused by the downhill assist control system**

- A sound may be heard from the engine compartment when the engine is started or just after the vehicle begins to move. This sound does not indicate that a malfunction has occurred in downhill assist control system.
- Either of the following conditions may occur when the downhill assist control system is operating. None of these are indicators that a malfunction has occurred.
  - Vibrations may be felt through the vehicle body and steering.
  - A motor sound may be heard after the vehicle comes to a stop.

■ **System malfunction**

In the following cases, have your vehicle checked by your Toyota dealer.

- The downhill assist control system indicator does not come on when the engine switch is turned to ON.
- The downhill assist control system indicator does not come on when the “DAC” switch is pressed.
- The slip indicator light comes on.



**WARNING**

■ **The system may not operate on the following surfaces, which may lead to an accident causing death or serious injury**

- Slippery surfaces such as wet or muddy roads
- Icy surface
- Unpaved roads

### Driving assist systems

**To keep driving safety and performance, the following systems operate automatically in response to various driving situations. Be aware, however, that these systems are supplementary and should not be relied upon too heavily when operating the vehicle.**

### Summary of the driving assist systems

#### ■ ABS (Anti-lock Brake System)

Helps to prevent wheel lock when the brakes are applied suddenly, or if the brakes are applied while driving on a slippery road surface

#### ■ Brake assist

Generates an increased level of braking force after the brake pedal is depressed when the system detects a panic stop situation

#### ■ VSC (Vehicle Stability Control)

Helps the driver to control skidding when swerving suddenly or turning on slippery road surfaces.

#### ■ Enhanced VSC (Enhanced Vehicle Stability Control)

Provides cooperative control of the ABS, TRAC, VSC and EPS.

Helps to maintain directional stability when swerving on slippery road surfaces by controlling steering performance.

#### ■ Trailer Sway Control

Helps the driver to control trailer sway by selectively applying brake pressure for individual wheels and reducing driving torque when trailer sway is detected.

#### ■ TRAC (Traction Control)

Helps to maintain drive power and prevent the drive wheels from spinning when starting the vehicle or accelerating on slippery roads

#### ■ Active Cornering Assist (ACA)

Helps to prevent the vehicle from drifting to the outer side by performing inner wheel brake control when attempting to accelerate while turning

#### ■ Hill-start assist control

Helps to reduce the backward movement of the vehicle when starting on an uphill

#### ■ EPS (Electric Power Steering)

Employs an electric motor to reduce the amount of effort



needed to turn the steering wheel

■ **Dynamic Torque Control AWD system (if equipped)**

Automatically switches from front-wheel drive to all-wheel drive (AWD) according to the driving conditions, helping to ensure reliable handling and stability. Examples of conditions where the system will switch to AWD are when cornering, going uphill, starting off or accelerating, and when the road surface is slippery due to snow, rain, etc.

■ **Dynamic Torque Vectoring AWD system (if equipped)**

Automatically switches from front wheel drive to all-wheel drive (AWD) according to the driving conditions, helping to ensure reliable handling and stability. Examples of conditions where the system will switch to AWD are when cornering, going uphill, starting off or accelerating, and when the road surface is slippery due to snow, rain, etc.

Also, when the vehicle is cornering, the drive torque distribution between the front and rear wheels and between the rear left and right wheels is precisely controlled to improve drivability and stability.

■ **The Secondary Collision Brake**

When the SRS airbag sensor

detects a collision and the system operates, the brakes and brake lights are automatically controlled to reduce the vehicle speed and help reduce the possibility of further damage due to a secondary collision.

■ **When the TRAC/VSC/Trailer Sway Control systems are operating**

The slip indicator light will flash while the TRAC/VSC/Trailer Sway Control systems are operating.

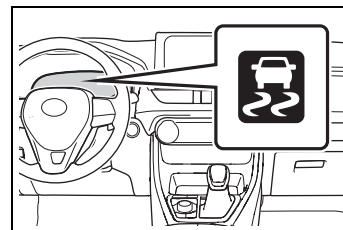

■ **Disabling the TRAC system**

If the vehicle gets stuck in mud, dirt or snow, the TRAC system may reduce power from the engine to the wheels.

Pressing  to turn the system off may make it easier for you to rock the vehicle in order to free it.

To turn the TRAC system off, quickly press and release .

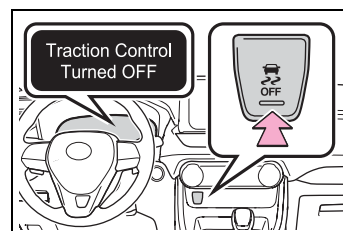

“Traction Control Turned OFF” will be shown on the multi-information display.

Press  again to turn the system

back on.

#### ■ Turning off the TRAC/VSC/Trailer Sway Control systems

To turn the TRAC/VSC/Trailer Sway Control systems off, press and hold



for more than 3 seconds while the vehicle is stopped.

The VSC OFF indicator light will come on and the "Traction Control Turned OFF" will be shown on the multi-information display.\*

Press again to turn the systems back on.

\*: PCS will also be disabled (only Pre-Collision warning is available). The PCS warning light will come on and a message will be displayed on the multi-information display. (→P.236)

#### ■ When the message is displayed on the multi-information display showing that TRAC has been disabled even if has not been pressed

TRAC is temporarily deactivated. If the information continues to show, contact your Toyota dealer.

#### ■ Operating conditions of hill-start assist control

When the following four conditions are met, the hill-start assist control will operate:

- The shift lever is in a position other than P or N (when starting off forward/backward on an upward incline).
- The vehicle is stopped.
- The accelerator pedal is not depressed.
- The parking brake is not engaged.

#### ■ Automatic system cancelation of hill-start assist control

The hill-start assist control will turn

off in any of the following situations:

- The shift lever is shifted to P or N.
- The accelerator pedal is depressed.
- The parking brake is engaged.
- No more than 2 seconds have elapsed after the brake pedal is released.

#### ■ Sounds and vibrations caused by the ABS, brake assist, VSC, Trailer Sway Control, TRAC and hill-start assist control systems

- A sound may be heard from the engine compartment when the brake pedal is depressed repeatedly, when the engine is started or just after the vehicle begins to move. This sound does not indicate that a malfunction has occurred in any of these systems.
- Any of the following conditions may occur when the above systems are operating. None of these indicates that a malfunction has occurred.
  - Vibrations may be felt through the vehicle body and steering.
  - A motor sound may be heard also after the vehicle comes to a stop.
  - The brake pedal may pulsate slightly after the ABS is activated.
  - The brake pedal may move down slightly after the ABS is activated.

#### ■ Active Cornering Assist operation sounds and vibrations

When the Active Cornering Assist is operated, operation sounds and vibrations may be generated from the brake system, but this is not a malfunction.

#### ■ AWD system operation sounds and vibrations when switching between AWD and front wheel drive

When the vehicle switches from AWD to front wheel drive and vice versa, operation sounds and vibrations may be generated, but this is not a malfunction.

■ **EPS operation sound**

When the steering wheel is operated, a motor sound (whirring sound) may be heard. This does not indicate a malfunction.

■ **Automatic reactivation of TRAC, Trailer Sway Control and VSC systems**

After turning the TRAC, Trailer Sway Control and VSC systems off, the systems will be automatically re-enabled in the following situations:

- When the engine switch is turned off.
- If only the TRAC system is turned off, the TRAC will turn on when vehicle speed increases.
- If both the TRAC and VSC systems are turned off, automatic re-enabling will not occur when vehicle speed increases.

■ **Operating conditions of Active Cornering Assist**

The system operates when the following occurs.

- TRAC/VSC can operate
- The driver is attempting to accelerate while turning
- The system detects that the vehicle is drifting to the outer side
- The brake pedal is released

■ **Reduced effectiveness of the EPS system**

The effectiveness of the EPS system is reduced to prevent the system from overheating when there is frequent steering input over an extended period of time. The steering wheel may feel heavy as a result. Should this occur, refrain from excessive steering input or stop the vehicle and turn the engine off. The EPS system should return to normal within 10 minutes.

■ **Secondary Collision Brake operating conditions**

The system operates when the SRS airbag sensor detects a collision

while the vehicle is in motion. However, the system does not operate in any of the following situations.

- The vehicle speed is below 6 mph (10 km/h)
- Components are damaged

■ **Secondary Collision Brake automatic cancellation**

The system is automatically canceled in any of the following situations.

- The vehicle speed drops below approximately 6 mph (10 km/h)
- A certain amount of time elapses during operation
- The accelerator pedal is depressed a large amount

■ **If a message about AWD is shown on the multi-information display (AWD models)**

Perform the following actions.

Message	Details/Actions
“AWD System Overheated Switching to 2WD Mode”	<p>AWD system is overheating. → <b>Perform the following actions.</b></p> <ul style="list-style-type: none"> <li>• Reduce the vehicle speed until the message disappears.</li> <li>• Stop the vehicle in a safe place and let the engine idle.*</li> </ul> <p>Once the display message on the multi-information display turns off, there is no problem continuing to drive.</p> <p>If the message does not disappear, have your vehicle checked by your Toyota dealer immediately.</p>
“AWD System Overheated 2WD Mode Engaged”	<p>The vehicle switched from all-wheel drive (AWD) to front wheel drive due to overheating. → <b>Perform the following actions.</b></p> <ul style="list-style-type: none"> <li>• Reduce the vehicle speed until the message disappears.</li> <li>• Stop the vehicle in a safe place and let the engine idle.*</li> </ul> <p>Once the display message on the multi-information display turns off, the AWD system returns to normal.</p> <p>If the message does not disappear, have your vehicle checked by your Toyota dealer immediately.</p>
“AWD System Malfunction 2WD Mode Engaged Visit Your Dealer”	<p>A malfunction occurred in the AWD system. → <b>Have your vehicle checked by your Toyota dealer immediately.</b></p>

\*: After stopping the vehicle, do not stop the engine until the display message has turned off.

**⚠ WARNING****■ The ABS does not operate effectively when**

- The limits of tire gripping performance have been exceeded (such as excessively worn tires on a snow covered road).
- The vehicle hydroplanes while driving at high speed on wet or slick roads.

**■ Stopping distance when the ABS is operating may exceed that of normal conditions**

The ABS is not designed to shorten the vehicle's stopping distance. Always maintain a safe distance from the vehicle in front of you, especially in the following situations:

- When driving on dirt, gravel or snow-covered roads
- When driving with tire chains
- When driving over bumps in the road
- When driving over roads with potholes or uneven surfaces

**■ TRAC/VSC may not operate effectively when**

Directional control and power may not be achievable while driving on slippery road surfaces, even if the TRAC/VSC system is operating. Drive the vehicle carefully in conditions where stability and power may be lost.

**■ Active Cornering Assist does not operate effectively when**

- Do not overly rely on Active Cornering Assist. Active Cornering Assist may not operate effectively when accelerating down slopes or driving on slippery road surfaces.

- When Active Cornering Assist frequently operates, Active Cornering Assist may temporarily stop operating to ensure proper operation of the brakes, TRAC and VSC.

**■ Hill-start assist control does not operate effectively when**

- Do not overly rely on hill-start assist control. Hill-start assist control may not operate effectively on steep inclines and roads covered with ice.
- Unlike the parking brake, hill-start assist control is not intended to hold the vehicle stationary for an extended period of time. Do not attempt to use hill-start assist control to hold the vehicle on an incline, as doing so may lead to an accident.

**■ When the TRAC/VSC/Trailer Sway Control is activated**

The slip indicator light flashes. Always drive carefully. Reckless driving may cause an accident. Exercise particular care when the indicator light flashes.

**■ When the TRAC/VSC/Trailer Sway Control systems are turned off**

Be especially careful and drive at a speed appropriate to the road conditions. As these are the systems to help ensure vehicle stability and driving force, do not turn the TRAC/VSC/Trailer Sway Control systems off unless necessary. Trailer Sway Control is part of the VSC system and will not operate if VSC is turned off or experiences a malfunction.

**WARNING****Dynamic Torque Vectoring AWD system (if equipped)**

The cornering performance of the newly developed AWD system has been improved. However, do not overly rely on the system and drive with caution.

**Replacing tires**

Make sure that all tires are of the specified size, brand, tread pattern and total load capacity. In addition, make sure that the tires are inflated to the recommended tire inflation pressure level. The ABS, TRAC and VSC/Trailer Sway Control systems will not function correctly if different tires are installed on the vehicle. Contact your Toyota dealer for further information when replacing tires or wheels.

**Handling of tires and the suspension**

Using tires with any kind of problem or modifying the suspension will affect the driving assist systems, and may cause a system to malfunction.

**Trailer Sway Control precaution**

The Trailer Sway Control system is not able to reduce trailer sway in all situations. Depending on many factors such as the conditions of the vehicle, trailer, road surface and driving environment, the Trailer Sway Control system may not be effective. Refer to your trailer owner's manual for information on how to tow your trailer properly.

**If trailer sway occurs**

Observe the following precautions. Failing to do so may cause death or serious injury.

- Firmly grip the steering wheel. Steer straight ahead. Do not try to control trailer swaying by turning the steering wheel.
- Begin releasing the accelerator pedal immediately but very gradually to reduce speed. Do not increase speed. Do not apply vehicle brakes.

If you make no extreme correction with the steering or brakes, your vehicle and trailer should stabilize. (→P.179)

**Secondary Collision Brake**

Do not rely solely upon the Secondary Collision Brake. This system is designed to help reduce the possibility of further damage due to a secondary collision, however, that effect changes according to various conditions. Overly relying on the system may result in death or serious injury.

Winter driving tips

**Carry out the necessary preparations and inspections before driving the vehicle in winter. Always drive the vehicle in a manner appropriate to the prevailing weather conditions.**

Pre-winter preparations

- Use fluids that are appropriate to the prevailing outside temperatures.
- Engine oil
- Engine coolant
- Washer fluid
- Have a service technician inspect the condition of the battery.
- Have the vehicle fitted with four snow tires or purchase a set of tire chains for the front tires.\*

Ensure that all tires are the same size and brand, and that chains match the size of the tires.

\*: Tire chains cannot be mounted on vehicles with 235/55R19 tires.

 **WARNING**

■ **Driving with snow tires**

Observe the following precautions to reduce the risk of accidents. Failure to do so may result in a loss of vehicle control and cause death or serious injury.

- Use tires of the specified size.

- Maintain the recommended level of air pressure.
- Do not drive in excess of 75 mph (120 km/h), regardless of the type of snow tires being used.
- Use snow tires on all, not just some wheels.

■ **Driving with tire chains (except 235/55R19 tires)**

Observe the following precautions to reduce the risk of accidents. Failure to do so may result in the vehicle being unable to be driven safely, and may cause death or serious injury.

- Do not drive in excess of the speed limit specified for the tire chains being used, or 30 mph (50 km/h), whichever is lower.
- Avoid driving on bumpy road surfaces or over potholes.
- Avoid sudden acceleration, abrupt steering, sudden braking and shifting operations that cause sudden engine braking.
- Slow down sufficiently before entering a curve to ensure that vehicle control is maintained.
- Do not use LTA (Lane Tracing Assist) system.

 **NOTICE**

■ **Repairing or replacing snow tires (vehicles with tire pressure warning system)**

Request repairs or replacement of snow tires from your Toyota dealer or legitimate tire retailers. This is because the removal and attachment of snow tires affects the operation of the tire pressure warning valves and transmitters.

### Before driving the vehicle

Perform the following according to the driving conditions:

- Do not try to forcibly open a window or move a wiper that is frozen. Pour warm water over the frozen area to melt the ice. Wipe away the water immediately to prevent it from freezing.
- To ensure proper operation of the climate control system fan, remove any snow that has accumulated on the air inlet vents in front of the windshield.
- Check for and remove any excess ice or snow that may have accumulated on the exterior lights, vehicle's roof, chassis, around the tires or on the brakes.
- Remove any snow or mud from the bottom of your shoes before getting in the vehicle.

### When driving the vehicle

Accelerate the vehicle slowly, keep a safe distance between you and the vehicle ahead, and drive at a reduced speed suitable to road conditions.

### When parking the vehicle

- Park the vehicle and move the shift lever to P without set-

ting the parking brake. The parking brake may freeze up, preventing it from being released. If the vehicle is parked without setting the parking brake, make sure to block the wheels.

Failure to do so may be dangerous because it may cause the vehicle to move unexpectedly, possibly leading to an accident.

When the parking brake is in automatic mode, release the parking brake after shifting the shift lever to P. (→P.203)

- If the vehicle is left parked with the brakes damp in cold temperatures, there is a possibility of the brakes freezing.
- If the vehicle is parked without setting the parking brake, confirm that the shift lever cannot be moved out of P\*.

\*: The shift lever will be locked if it is attempted to be shifted from P to any other position without depressing the brake pedal. If the shift lever can be shifted from P, there may be a problem with the shift lock system. Have the vehicle inspected by your Toyota dealer immediately.



**⚠ WARNING**

■ **When parking the vehicle**  
 When parking the vehicle without applying the parking brake, make sure to chock the wheels. If you do not chock the wheels, the vehicle may move unexpectedly, possibly resulting in an accident.

**Selecting tire chains**

▶ Vehicles without 235/55R19 tires

Use the correct tire chain size when mounting the tire chains. Chain size is regulated for each tire size.

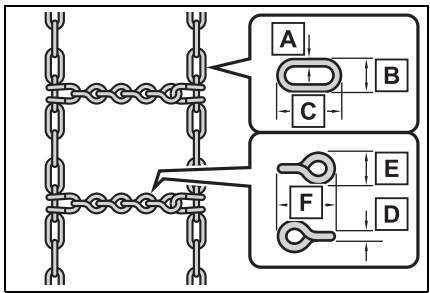

- Side chain:
- A** 0.12 in. (3 mm) in diameter
  - B** 0.39 in. (10 mm) in width
  - C** 1.18 in. (30 mm) in length
- Cross chain:
- D** 0.16 in. (4 mm) in diameter
  - E** 0.55 in. (14 mm) in width
  - F** 0.98 in. (25 mm) in length

▶ Vehicles with 235/55R19 tires  
 Tire chains cannot be mounted.  
 Snow tires should be used

instead.

**Regulations on the use of tire chains (except 235/55R19 tires)**

Regulations regarding the use of tire chains vary depending on location and type of road. Always check local regulations before installing chains.

■ **Tire chain installation**

Observe the following precautions when installing and removing chains:

- Install and remove tire chains in a safe location.
- Install tire chains on the front tires only. Do not install tire chains on the rear tires.
- Install tire chains on front tires as tightly as possible. Retighten chains after driving 1/4 - 1/2 mile (0.5 - 1.0 km).
- Install tire chains following the instructions provided with the tire chains.

**⚠ NOTICE**

■ **Fitting tire chains (vehicles with tire pressure warning system)**  
 The tire pressure warning valves and transmitters may not function correctly when tire chains are fitted.

### Utility vehicle precautions

**This vehicle belongs to the utility vehicle class, which has higher ground clearance and narrower tread in relation to the height of its center of gravity to make it capable of performing in a wide variety of off-road applications.**

### Utility vehicle feature

- Specific design characteristics give it a higher center of gravity than ordinary passenger cars. This vehicle design feature causes this type of vehicle to be more likely to rollover. And, utility vehicles have a significantly higher rollover rate than other types of vehicles.
- An advantage of the higher ground clearance is a better view of the road allowing you to anticipate problems.
- It is not designed for cornering at the same speeds as ordinary passenger cars any more than low-slung sports cars are designed to perform satisfactorily under off-road conditions. Therefore, sharp turns at excessive speeds may cause the vehicle to rollover.

### WARNING

#### ■ Utility vehicle precautions

Always observe the following precautions to minimize the risk of death, serious injury or damage to your vehicle:

- In a rollover crash, an unbelted person is significantly more likely to die than a person wearing a seat belt. Therefore, the driver and all passengers should always fasten their seat belts.
- Avoid sharp turns or abrupt maneuvers, if at all possible. Failure to operate this vehicle correctly may result in loss of control or vehicle rollover causing death or serious injury.
- Loading cargo on the roof luggage carrier (if equipped) will make the center of the vehicle gravity higher. Avoid high speeds, sudden starts, sharp turns, sudden braking or abrupt maneuvers, otherwise it may result in loss of control or vehicle rollover due to failure to operate this vehicle correctly.
- Always slow down in gusty crosswinds. Because of its profile and higher center of gravity, your vehicle is more sensitive to side winds than an ordinary passenger car. Slowing down will allow you to have better control.
- Do not drive horizontally across steep slopes. Driving straight up or straight down is preferred. Your vehicle (or any similar off-road vehicle) can tip over sideways much more easily than forward or backward.

### Off-road driving

When driving your vehicle off-

road, please observe the following precautions to ensure your driving enjoyment and to help prevent the closure of areas to off-road vehicles:

- Drive your vehicle only in areas where off-road vehicles are permitted to travel.
- Respect private property. Get owner's permission before entering private property.
- Do not enter areas that are closed. Honor gates, barriers and signs that restrict travel.
- Stay on established roads. When conditions are wet, driving techniques should be changed or travel delayed to prevent damage to roads.

#### ■ Additional information for off-road driving

- ▶ For owners in U.S. mainland, Hawaii and Puerto Rico:

To obtain additional information pertaining to driving your vehicle off-road, consult the following organizations:

- State and Local Parks and Recreation Departments
- State Motor Vehicle Bureau
- Recreational Vehicle Clubs
- U.S. Forest Service and Bureau of Land Management



#### WARNING

##### ■ Off-road driving precautions

Always observe the following precautions to minimize the risk of death, serious injury or damage to your vehicle:

- Drive carefully when off the road. Do not take unnecessary risks by driving in dangerous places.
- Do not grip the steering wheel spokes when driving off-road. A bad bump could jerk the wheel and injure your hands. Keep both hands and especially your thumbs on the outside of the rim.
- Always check your brakes for effectiveness immediately after driving in sand, mud, water or snow.
- After driving through tall grass, mud, rock, sand, rivers, etc., check that there is no grass, bush, paper, rags, stone, sand, etc. adhering or trapped on the underbody. Clear off any such matter from the underbody. If the vehicle is used with these materials trapped or adhering to the underbody, a breakdown or fire could occur.

 **WARNING**

- When driving off-road or in rugged terrain, do not drive at excessive speeds, jump, make sharp turns, strike objects, etc. This may cause loss of control or vehicle rollover causing death or serious injury. You are also risking expensive damage to your vehicle's suspension and chassis.

 **NOTICE****■ To prevent the water damage**

Take all necessary safety measures to ensure that water damage to the engine or other components does not occur.

- Water entering the engine air intake will cause severe engine damage.
- Water entering the automatic transmission will cause deterioration in shift quality, locking up of your transmission accompanied by vibration, and ultimately damage.
- Water can wash the grease from wheel bearings, causing rusting and premature failure, and may also enter the differentials, transmission and transfer case (AWD models), reducing the gear oil's lubricating qualities.

**■ When you drive through water**

If driving through water, such as when crossing shallow streams, first check the depth of the water and the bottom of the riverbed for firmness. Drive slowly and avoid deep water.

**■ Inspection after off-road driving**

- Sand and mud that has accumulated around brake discs may affect braking efficiency and may damage brake system components.
- Always perform a maintenance inspection after each day of off-road driving that has taken you through rough terrain, sand, mud, or water. For scheduled maintenance information, refer to the "Scheduled Maintenance Guide" or "Owner's Manual Supplement".

- 5-1. Basic function**
  - Buttons overview..... 375
  - Menu screen ..... 377
  - Status icon ..... 378
  - “Setup” screen ..... 380
- 5-2. Basic information before operation**
  - Initial screen..... 381
  - Touch screen..... 382
  - Home screen..... 384
  - Entering letters and numbers/list screen operation ..... 385
  - Screen adjustment..... 388
  - Linking multi-information display and the system ..... 389
- 5-3. Connectivity settings**
  - Registering/Connecting a Bluetooth® device ..... 390
  - Setting Bluetooth® details ..... 394
  - Wi-Fi® Hotspot ..... 402
- 5-4. Apple CarPlay/Android Auto**
  - Apple CarPlay®/Android Auto..... 407
- 5-5. Other settings**
  - General settings..... 414
  - Voice settings..... 418
  - Vehicle settings ..... 419
- 5-6. Using the audio/visual system**
  - Quick reference..... 420
  - Some basics..... 421
- 5-7. Radio operation**
  - AM/FM/SiriusXM (SXM) radio ..... 425
- 5-8. Media operation**
  - USB memory..... 432
  - iPod/iPhone (Apple CarPlay) ..... 434
  - Android Auto..... 437
  - Bluetooth® audio ..... 438
- 5-9. Audio/visual remote controls**
  - Steering switches ..... 442
- 5-10. Audio settings**
  - Setup..... 444
- 5-11. Tips for operating the audio/visual system**
  - Operating information.. 446
- 5-12. Voice command system operation**
  - Voice command system ..... 458
  - Command list ..... 461
- 5-13. Phone operation (Hands-free system for cellular phones)**
  - Quick reference..... 465
  - Some basics..... 466

---

Placing a call using the Bluetooth® hands-free system .....	470
Receiving a call using the Bluetooth® hands-free system .....	473
Talking on the Bluetooth® hands-free system.....	474
Bluetooth® phone message function.....	476
<b>5-14.Phone settings</b>	
Setup.....	481
<b>5-15.What to do if... (Bluetooth®)</b>	
Troubleshooting .....	491
<b>5-16.Connected Services overview</b>	
Connected Services....	495
Type A: Function achieved by using a smartphone or DCM .....	496
Type B: Function achieved by using DCM and the system .....	498
Type C: Function achieved by using DCM.....	499
Type D: Function achieved by using DCM and a smartphone .....	502
<b>5-17.Connected Services operation</b>	
Toyota Apps .....	504
<b>5-18.Setup</b>	
Toyota Apps settings ...	508

## Buttons overview\*

\*: Vehicles with Audio only

For details about Audio Plus or Premium Audio, refer to “Navigation and Multimedia System Owner’s Manual”.

## Operations of each part

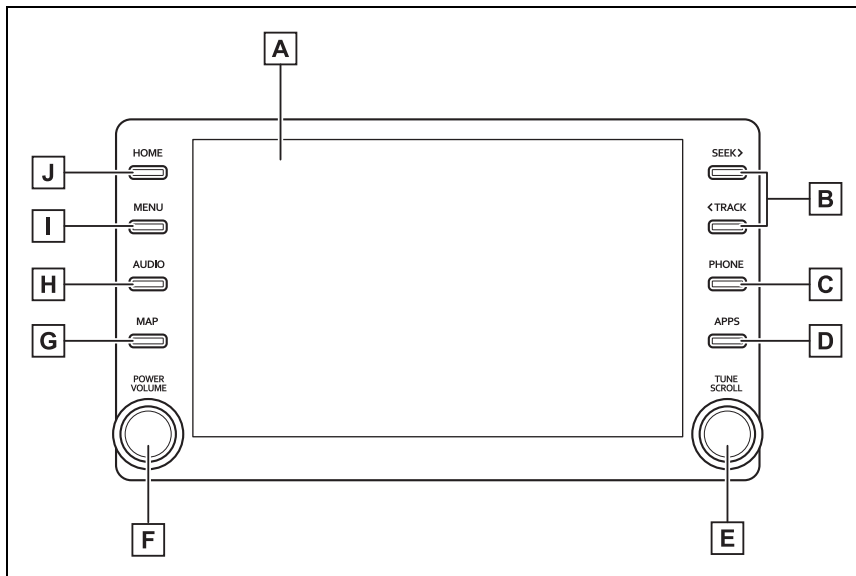

- A** By touching the screen with your finger, you can control the selected functions. (→P.382, 383)
- B** Press to seek up or down for a radio station or to access a desired track/file. (→P.425, 432, 434, 438)
- C** Press to access the Bluetooth® hands-free system. (→P.465)
- When an Apple CarPlay connection is established, press to display the Phone application screen.\*1
- D** Press to display the Toyota Apps screen.\*1, 2 (→P.504)
- E** Turn to change the radio station or skip to the next or previous track/file. (→P.425, 432, 434, 438)
- F** Press to turn the audio/visual system on and off, and turn it to adjust the volume. Press and hold to restart the system. (→P.381, 421)

**G** When an Apple CarPlay/Android Auto connection is established, press to display the Maps application screen.\*<sup>1</sup>

**H** Press to display the audio/visual system screen. (→420, 421)

**I** Press to display the “Menu” screen. (→P.377)

**J** Press to display the home screen. (→P.384)

\*<sup>1</sup>: This function is not made available in some countries or areas.

\*<sup>2</sup>: When an Apple CarPlay/Android Auto connection is established, this function will be unavailable.

 **WARNING**

● For safety, the driver should not operate the system while he/she is driving. Insufficient attention to the road and traffic may cause an accident.

---

● The screen shots in this document and the actual screens of the system differ depending on whether the functions and/or a contract existed.



## Menu screen

## Menu screen operation

Press the “MENU” button to display the “Menu” screen.



- A** Displays the clock. Select to display the clock settings screen. (→P.415)
- B** Select to display the audio control screen. (→P.420)
- C** Select to display the hands-free operation screen. (→P.465)
  - When an Apple CarPlay connection is established, select to display the Phone application screen.\*1
- D** Select to display the Toyota Apps screen.\*1, 2 (→P.504)
- E** When an Apple CarPlay/Android Auto connection is established and this button displays “Apple CarPlay”/“Android Auto”, select to display the home screen of Apple CarPlay/Android Auto.\*1 (→P.407)
- F** Select to display the fuel consumption screen. (→P.99)
- G** Select to display the “Setup” screen. (→P.380)
- H** Select to adjust the contrast, brightness, etc. of the display. (→P.388)

\*1: This function is not made available in some countries or areas.

\*2: When an Apple CarPlay/Android Auto connection is established, this function will be unavailable.

### Status icon

Status icons are displayed at the top of the screen.

### Status icon explanation



- A** Indicate during data communication performed via Data Communication Module (DCM)<sup>\*1</sup>
- B** The reception level of Data Communication Module (DCM) display<sup>\*1</sup> (→P.378)
- C** The reception level of the connected phone display (→P.378)
- D** Remaining battery charge display (→P.379)
- E** Bluetooth<sup>®</sup> phone connection condition display (→P.379)
- F** Wi-Fi<sup>®</sup> connection condition display<sup>\*1, 2</sup> (→P.402)

<sup>\*1</sup>: Vehicles equipped with DCM

<sup>\*2</sup>: This function is not made available in some countries or areas.

- The number of status icons that can be displayed differs depending on the displayed screen.

### Reception level display

The level of reception does not always correspond with the level displayed on the cellular phone. The level of reception may not be displayed depending on the phone you have.



When the cellular phone is out of the service area or in a place inaccessible by radio waves,

 is displayed.



“Rm” is displayed when receiving in a roaming area. While roaming, display “Rm” top-left on the icon.

The receiving area may not be displayed depending on the type of Bluetooth<sup>®</sup> phone you have.



- ▶ While connected with cellular phone

Reception Level	Indicators
Poor	
Excellent	

- ▶ While using Data Communication Module (DCM)

Reception Level	Indicators
Poor	
Excellent	

- ▶ While using Wi-Fi® Hotspot

Reception Level	Indicators
No connection	
Connected	



- When Wi-Fi® Hotspot is off, no item is displayed.

**Remaining battery charge display**

The amount displayed does not always correspond with the amount displayed on the Bluetooth® device.

The amount of battery charge left may not be displayed depending on the type of the Bluetooth® device connected.

This system does not have a charging function.

Remaining charge	Indicators
Empty	
Full	

**Bluetooth® connection condition display**



An antenna for the Bluetooth® connection is built into the instrument panel.

The condition of the Bluetooth® connection may deteriorate and the system may not function when a Bluetooth® phone is used in the following conditions and/or places:

The cellular phone is obstructed by certain objects (such as when it is behind the seat or in the glove box or console box).

The cellular phone is touching or is covered with metal materials.

Leave the Bluetooth® phone in a place where the condition of the Bluetooth® connection is good.

Indicators	Conditions
 (Blue)	Indicates that the condition of the Bluetooth® connection is good.
 (Gray)	While in this condition, sound quality during phone calls may deteriorate.
	Indicates that the cellular phone is not connected via Bluetooth®.

## “Setup” screen

### “Setup” screen

Press the “MENU” button, then select “Setup” to display the “Setup” screen. The items shown on the “Setup” screen can be set.

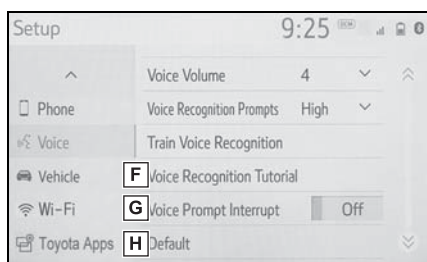
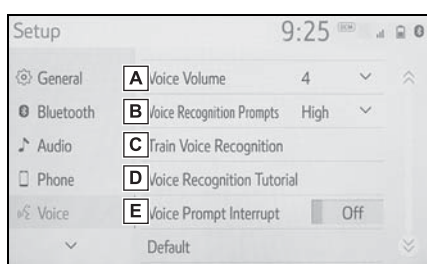

- F** Select to set vehicle information. (→P.419)
- G** Select to set Wi-Fi® connection settings.\*1, 2 (→P.403)
- H** Select to set Toyota Apps settings.\*2 (→P.508)

\*1: Vehicles equipped with DCM

\*2: This function is not made available in some countries or areas.

- A** Select to change the selected language, operation sound settings, etc. (→P.414)
- B** Select to set Bluetooth® device and Bluetooth® system settings. (→P.394)
- C** Select to set audio settings. (→P.444)
- D** Select to set the phone sound, contacts, message settings, etc. (→P.481)
- E** Select to set the voice settings. (→P.418)

### Initial screen

**When the engine switch is turned to ACC or ON, the initial screen will be displayed and the system will begin operating.**

### Caution screen

After a few seconds, the caution screen will be displayed.

After about 5 seconds or selecting “Continue”, the caution screen automatically switches to the next screen.

#### **WARNING**

- When the vehicle is stopped with the engine running, always apply the parking brake for safety.

### Restarting the system

When system response is extremely slow, the system can be restarted.

- 1 Press and hold the “POWER VOLUME” knob for 3 seconds or more.

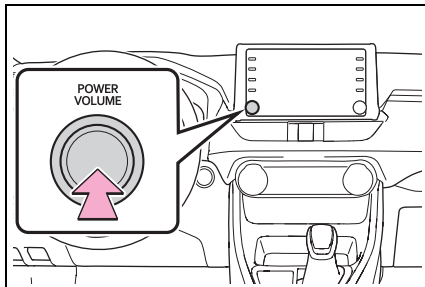

## Touch screen

## Touch screen gestures

Operations are performed by touching the touch screen directly with your finger.

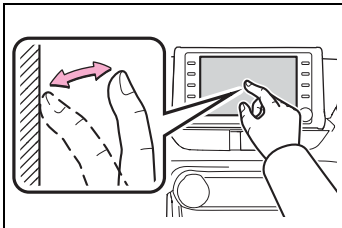
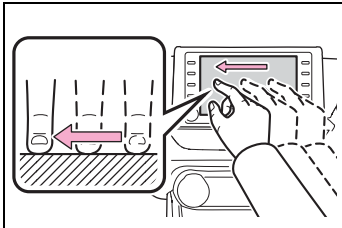
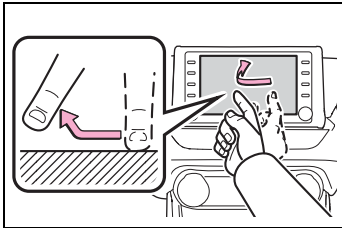
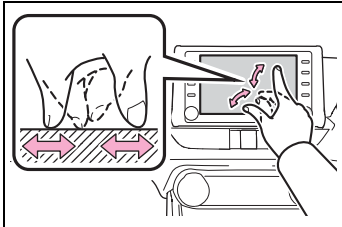
Operation method	Outline	Main use
	<ul style="list-style-type: none"> <li>• Touch</li> </ul> <p>Quickly touch and release once.</p>	<ul style="list-style-type: none"> <li>• Selecting an item on the screen</li> </ul>
	<ul style="list-style-type: none"> <li>• Drag<sup>*1</sup></li> </ul> <p>Touch the screen with your finger, and move the screen to the desired position.</p>	<ul style="list-style-type: none"> <li>• Scrolling the lists</li> </ul>
	<ul style="list-style-type: none"> <li>• Flick<sup>*1</sup></li> </ul> <p>Quickly move the screen by flicking with your finger.</p>	<ul style="list-style-type: none"> <li>• Scrolling the main screen page</li> </ul>
	<ul style="list-style-type: none"> <li>• Pinch in/Pinch out</li> </ul> <p>Slide fingers toward each other or apart on the screen.</p>	<ul style="list-style-type: none"> <li>• Changing the scale of the map<sup>*2</sup></li> </ul>

\*1: The above operations may not be performed on all screens.



\*2: The Apple CarPlay Maps application is not compatible with pinch multi-touch gestures.

- Flick operations may not be performed smoothly at high altitudes.

### Touch screen operation

**This system is operated mainly by the buttons on the screen. (Referred to as screen buttons in this manual.)**

**When a screen button is touched, a beep sounds. (To set the beep sound: →P.414)**

- If the system does not respond to touching a screen button, move your finger away from the screen and then touch it again.
- Dimmed screen buttons cannot be operated.
- The displayed image may become darker and moving images may be slightly distorted when the screen is cold.
- In extremely cold conditions, the screen may not be displayed and the data input by a user may be deleted. Also, the screen buttons may be harder than usual to depress.
- When you look at the screen through polarized material such as polarized sunglasses, the screen may be dark and hard to see. If so, look at the screen from different angles, adjust the screen settings on the display settings screen or take off your sunglasses.
- When  is displayed on the screen, select  to return to the previous screen.

### NOTICE

- To prevent damaging the screen, lightly touch the screen buttons with your finger.
- Do not use objects other than your finger to touch the screen.
- Wipe off fingerprints using a glass cleaning cloth. Do not use chemical cleaners to clean the screen, as they may damage the touch screen.

### Capacitive touch screen buttons

The operable areas of the capacitive touch screen buttons use capacitive touch sensors and may not operate properly in the following situations:

- If the screen is dirty or wet
- If a source of strong electromagnetic waves is brought near the screen
- If a glove is worn during operation
- If the screen is touched by a fingernail
- If a stylus is used to operate the buttons
- If your palm touches the operable area of another button during operation
- If a button is touched quickly
- If the operable part of a capacitive touch screen button is touched by or covered

with a metal object, such as the following, it may not operate properly:

- Magnetic isolation cards
  - Metallic foil, such as the inner packaging of a cigarette box
  - Metallic wallets or bags
  - Coins
  - Discs, such as a CD or DVD
  - If the operable part of a capacitive touch screen button is wiped, it may operate unintentionally.
  - If the capacitive touch screen button is being touched when the engine switch is changed to ACC or ON, the button may not operate properly. In this case, remove anything touching the button, turn the engine switch off and then turn it to ACC or ON, or restart the system by press and hold the "POWER VOLUME" knob for 3 seconds or more.
- 
- Capacitive touch screen button sensor sensitivity can be adjusted. (→P.414)

## Home screen

**On the home screen, multiple screens, such as the audio/visual system screen, hands-free screen and clock screen, can be displayed simultaneously.**

## Home screen operation

- 1 Press the "HOME" button.

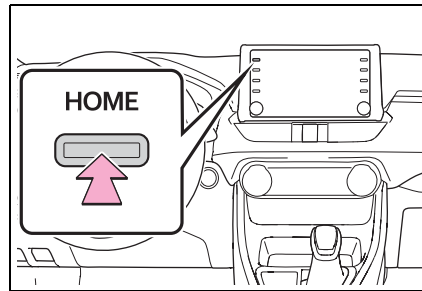

- 2 Check that the home screen is displayed.

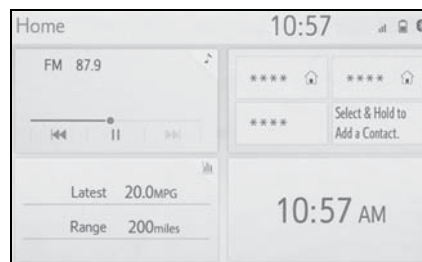

- Selecting a screen will display it full screen.
- 
- The display information and area on the home screen can be customized.
  - The home screen can be set to several types of split layouts



**Customizing the home screen**

- The display information/area on the home screen and the home screen layout can be changed.
- 1 Press the "MENU" button.
  - 2 Select "Setup".
  - If the general settings screen is not displayed, select "General".
  - 3 Select "Customize Home Screen".
  - 4 Select the items to be set.

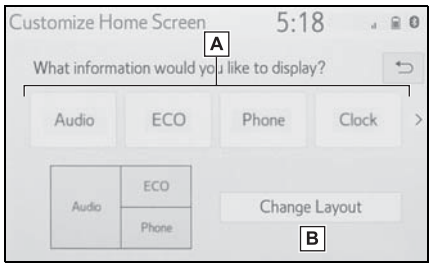

- A** Select to change the display information and area on the home screen.
- B** Select to change the home screen layout.

**Entering letters and numbers/list screen operation**

**Entering letters and numbers**

When searching by a name or entering data, letters and numbers can be entered via the screen.

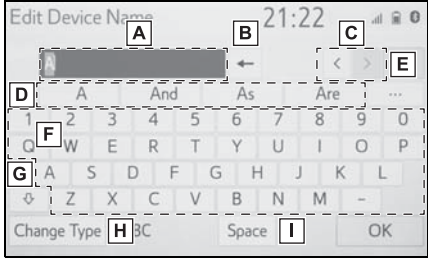

- A** Text field. Entered character(s) will be displayed.
- B** Select to erase one character. Select and hold to continue erasing characters.
- C** Select to move the cursor.
- D** Select to choose predictive text candidate for entered text. (→P.386)
- E** Select to display a list of predictive text candidates when there is more than one. (→P.386)
- F** Select to enter desired characters.
- G** Select to enter characters in lower case or in upper case.

5

Audio

**H** Select to change character types. (→P.386)

**I** Select to make a space on cursor.

● Keyboard layout can be changed. (→P.414)

**Changing character type**

1 Select “Change Type”.

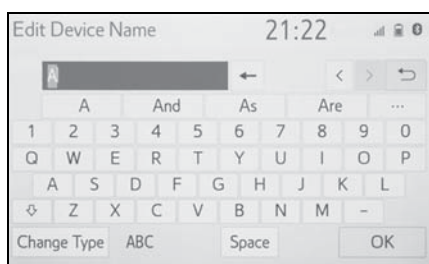

2 Select the desired character.

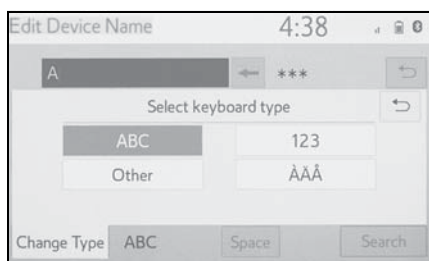

● Depending on the screen being displayed, it may not be possible to change keyboard characters.

**Displaying predictive text candidates**

When text is input, the system predicts the text that may complete the currently unconfirmed text and displays predictive replacement candidates that match the beginning of the text.

1 Input text.  
2 Select the desired candidate.

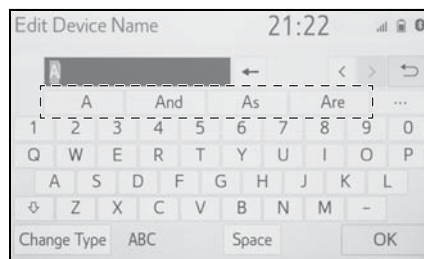

● To select a candidate that is not displayed, select **\*\*\***, and then select the desired predictive replacement candidate.

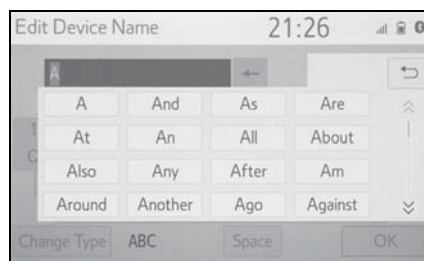



**List screen**

The list screen may be displayed after entering characters. When a list is displayed, use the appropriate screen button to scroll through the list.

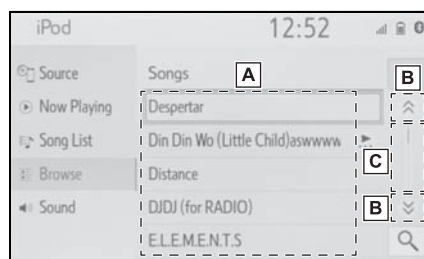
**Scrolling list screen**





- A To scroll up/down the list, flick the list up/down.
- B Select to skip to the next or previous page. Select and hold  or  to scroll through the displayed list.
- C Indicates the position of the displayed entries in the entire list. To scroll up/down pages, drag the bar.

2 Input text.



3 Select "Search".

4 The list is displayed.

- If  appears to the right of an item name, the complete name is too long to display.
- Select to  scroll to the end of the name.
- Select  to move to the beginning of the name.

### Searching a list

Items are displayed in the list with the most similar results of the search at the top.

1 Select .



5

Audio

## Screen adjustment

The contrast and brightness of the screen display and the image of the camera display can be adjusted. The screen can also be turned off, and/or changed to either day or night mode.

(For information regarding audio/visual screen adjustment: →P.423)

## Displaying the screen adjustment screen

- 1 Press the “MENU” button.

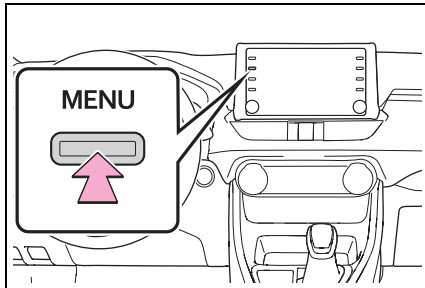

- 2 Select “Display”.
- 3 Select the desired items to be set.



- 1 Select to turn the screen off. To turn it on, press any but-

ton.

- Select to turn day mode on/off. (→P.388)
- Select to adjust the screen display. (→P.388)
- Select to adjust the camera display.

- When the screen is viewed through polarized sunglasses, a rainbow pattern may appear on the screen due to optical characteristics of the screen. If this is disturbing, please operate the screen without polarized sunglasses.

## Changing between day and night mode

Depending on the position of the headlight switch, the screen changes to day or night mode. This feature is available when the headlight is switched on.

- 1 Select “Day Mode”.

- If the screen is set to day mode with the headlight switch turned on, this condition is memorized even with the engine turned off.

## Adjusting the contrast/brightness

The contrast and brightness of the screen can be adjusted according to the brightness of your surroundings.

- 1 Select “General” or “Camera”.
- 2 Select the desired item.

- “Display (General)” screen only: Select “<” or “>” to select the desired display.
- “Contrast”  
“+”: Select to strengthen the contrast of the screen.  
“-”: Select to weaken the contrast of the screen.
- “Brightness”  
“+”: Select to brighten the screen.  
“-”: Select to darken the screen.

Linking multi-information display and the system

**The following functions of the system are linked with the multi-information display in the instrument cluster:**

- Audio
- Phone\*

**etc.**

**These functions can be operated using multi-information display control switches on the steering wheel. (→P.89)**

\*: When an Apple CarPlay connection is established, this function will be unavailable.

### Registering/Connecting a Bluetooth® device

To use the hands-free system, it is necessary to register a Bluetooth® phone with the system.

Once the phone has been registered, it is possible to use the hands-free system.

This operation cannot be performed while driving.

When an Apple CarPlay connection is established, Bluetooth® functions of the system will become unavailable and any connected Bluetooth® devices will be disconnected.

When connecting to Android Auto, a Bluetooth® connection will be made automatically.

When an Android Auto connection is established, some Bluetooth® functions other than hands-free system cannot be used.

### Registering a Bluetooth® phone for the first time

#### ■ Registering from the system

- 1 Turn the Bluetooth® connection setting of your cellular phone on.
  - This function is not available when Bluetooth® connection setting of your cellular phone is set to off.
- 2 Press the “MENU” button.

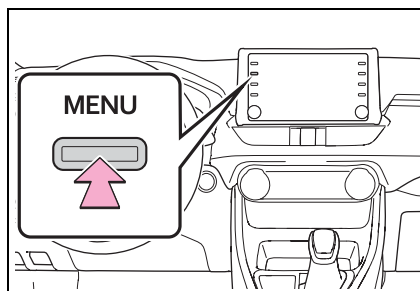

- 3 Select “Phone”.
  - Operations up to this point can also be performed by pressing the “PHONE” button on the instrument panel.
- 4 Select “Yes” to register a phone.



- 5 Select the desired Bluetooth® device.

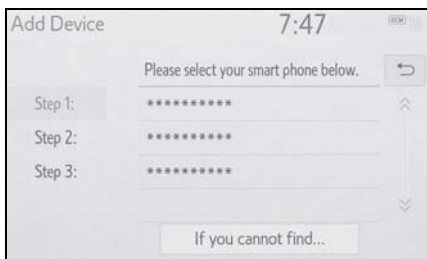

- If the desired Bluetooth® phone is not on the list, select “If you cannot find...” and follow the guidance on the screen. (→P.392)

- 6 Register the Bluetooth® device using your Bluetooth® device.



- For details about operating the Bluetooth® device, see the manual that comes with it.
- A PIN code is not required for SSP (Secure Simple Pairing) compatible Bluetooth® devices. Depending on the type of Bluetooth® device being connected, a message confirming registration may be displayed on the Bluetooth® device’s screen.

Respond and operate the Bluetooth® device according to the confirmation message.

- 7 Check that the following screen is displayed, indicating pairing was successful (a Bluetooth® link has been established but registration is not yet complete).

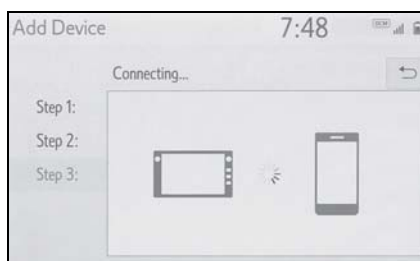

- The system is connecting to the registered device.
- At this stage, the Bluetooth® functions are not yet available.

- 8 Check that “Connected” is displayed and registration is complete.



- If an error message is displayed, follow the guidance on the screen to try again.
- If a cellular phone does not operate properly after being con-

nected, turn the cellular phone off and on and then connect it again.

■ **Registering from phone**

- 1 Select "If you cannot find...".

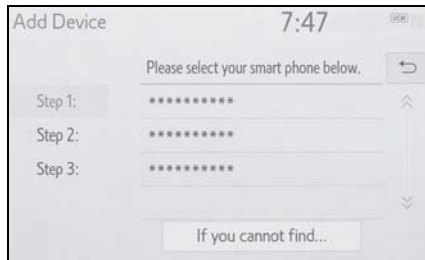

- 2 Select "Register from Phone".

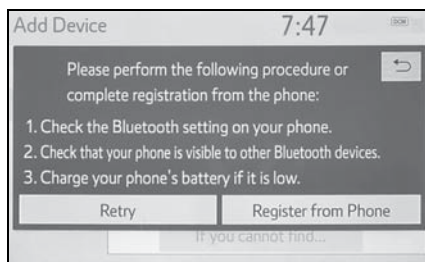

- 3 Check that the following screen is displayed, and register the Bluetooth® device using your Bluetooth® device.

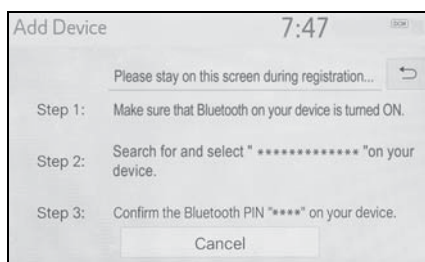

- For details about operating the Bluetooth® device, see the manual that comes with it.
- A PIN code is not required for

SSP (Secure Simple Pairing) compatible Bluetooth® devices. Depending on the type of Bluetooth® device being connected, a message confirming registration may be displayed on the Bluetooth® device's screen. Respond and operate the Bluetooth® device according to the confirmation message.

- 4 Follow the steps in "Registering a Bluetooth® phone for the first time" from step 7. (→P.390)

**Registering a Bluetooth® audio player for the first time**

To use the Bluetooth® audio, it is necessary to register an audio player with the system.

Once the player has been registered, it is possible to use the Bluetooth® audio.

This operation cannot be performed while driving.

For details about registering a Bluetooth® device: →P.397

- 1 Turn the Bluetooth® connection setting of your audio player on.
- This function is not available when the Bluetooth® connection setting of your audio



player is set to off.

- 2 Press the "AUDIO" button.

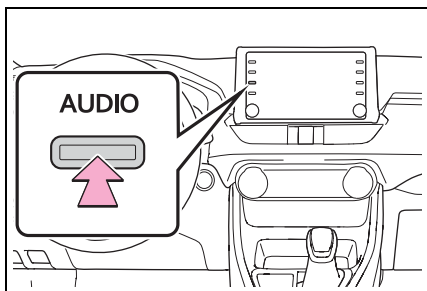

- 3 Select "Source" on the audio screen or press "AUDIO" button again.
- 4 Select "Bluetooth".
- 5 Select "Yes" to register an audio player.
- 6 Follow the steps in "Registering a Bluetooth® phone for the first time" from step 5. (→P.390)

### Profiles

This system supports the following services.

#### ■ Bluetooth® Core Specification

- Ver. 2.0 (Recommended: Ver. 4.2)

#### ■ Profiles

- HFP (Hands Free Profile) Ver. 1.0 (Recommended: Ver. 1.7)
  - This is a profile to allow hands-free phone calls using a cellular phone. It has outgoing and incoming call functions.

- OPP (Object Push Profile) Ver. 1.1 (Recommended: Ver. 1.2)

- This is a profile to transfer contacts data.

- PBAP (Phone Book Access Profile) Ver. 1.0 (Recommended: Ver. 1.2)

- This is a profile to transfer phone-book data.

- MAP (Message Access Profile) Ver. 1.0 (Recommended: Ver. 1.2)

- This is a profile to use phone message functions.

- SPP (Serial Port Profile) Recommended: Ver. 1.2

- This is a profile to use the Toyota audio multimedia function.

- A2DP (Advanced Audio Distribution Profile) Ver. 1.0 (Recommended: Ver. 1.3)

- This is a profile to transmit stereo audio or high quality sound to the audio/visual system.

- AVRCP (Audio/Video Remote Control Profile) Ver. 1.0 (Recommended: Ver. 1.6)

- This is a profile to allow remote control the A/V equipment.

- 
- This system is not guaranteed to operate with all Bluetooth® devices.

- If your cellular phone does not support HFP, registering the Bluetooth® phone or using OPP, PBAP, MAP or SPP profiles individually will not be possible.

- If the connected Bluetooth® device version is older than recommended or incompatible, the Bluetooth® device function may not work properly.
- Refer to <http://www.toyota.com/audio-multimedia> in the United States, <http://www.toyota.ca/connected> in Canada, and <http://www.toyotapr.com/audio-multimedia> in Puerto Rico, to find approved Bluetooth® phones for this system.
- Certification



Bluetooth is a registered trademark of Bluetooth SIG, Inc.

### Setting Bluetooth® details

**When an Apple CarPlay connection is established, this function will be unavailable.\***

**When an Android Auto connection is established, some functions will be unavailable.\***

\*: This function is not made available in some countries or areas.

### Displaying the Bluetooth® setup screen

- 1 Press the "MENU" button.

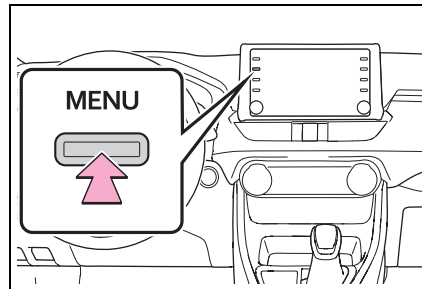

- 2 Select "Setup".
- 3 Select "Bluetooth".

- 4 Select the desired item to be set.

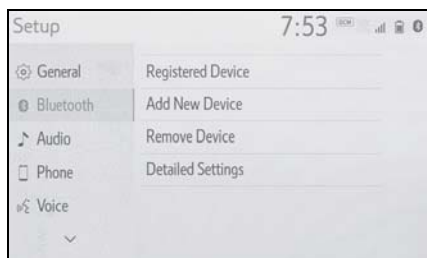

### Bluetooth® setup screen

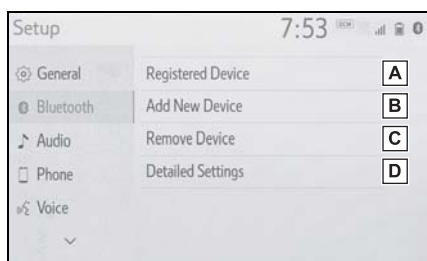

- A** Connecting a Bluetooth® device and editing the Bluetooth® device information (→P.395, 398)
- B** Registering a Bluetooth® device (→P.397)
- C** Deleting a Bluetooth® device (→P.397)
- D** Setting the Bluetooth® system (→P.399)

### Connecting a Bluetooth® device

Up to 5 Bluetooth® devices (Phones (HFP) and audio players (AVP)) can be registered.

If more than 1 Bluetooth® device

has been registered, select which device to connect to.

- 1 Display the Bluetooth® settings screen. (→P.394)
- 2 Select “Registered Device”.
- 3 Select the device to be connected.

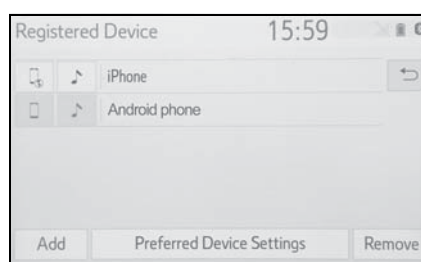

“Add”: Registering a Bluetooth® device. (→P.397)

“Preferred Device Settings”: Select to change the automatic connection priority of the registered Bluetooth® devices. (→P.400)

“Remove”: Deleting a Bluetooth® device. (→P.397)

: Phone

: Audio player

: Phone/Toyota Apps Services

- The profile icon for a currently connected device will be displayed in color.
- Selecting a profile icon which is not currently connected will switch the connection to the function.

- If the desired Bluetooth® device is not on the list, select “Add New Device” to register the device. (→P.397)

- 4 Select the desired connection.

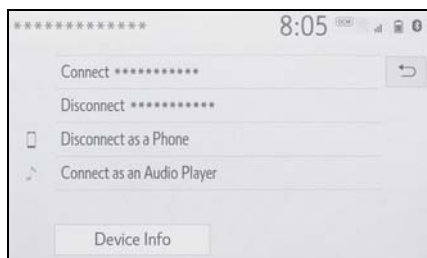

- “Device Info”: Select to confirm and change the Bluetooth® device information. (→P.398)
  - ▶ When another Bluetooth® device is connected
  - To disconnect the Bluetooth® device, select “Yes”.
- 5 Check that a confirmation screen is displayed when the connection is complete.
- If an error message is displayed, follow the guidance on the screen to try again.
- 
- It may take time if the device connection is carried out during Bluetooth® audio playback.
  - Depending on the type of Bluetooth® device being connected, it may be necessary to perform additional steps on the device.
  - When disconnecting a Bluetooth® device, it is recommended to disconnect using the system.

■ **Connecting a Bluetooth® device in a different way (from phone top screen)**

→P.467

■ **Connecting a Bluetooth® device in a different way (from phone setup screen)**

→P.481

■ **Connecting a Bluetooth® device in a different way (from Bluetooth® audio screen)**

→P.440

■ **Auto connection mode**

To turn auto connection mode on, set “Bluetooth Power” to on. (→P.399) Leave the Bluetooth® device in a location where the connection can be established.

- When the engine switch is in ACC or ON, the system searches for a nearby registered device.
- The system will connect with the registered device that was last connected, if it is nearby. When automatic connection priority is set to on and there is more than one registered Bluetooth® phone available, the system will automatically connect to the Bluetooth® phone with the highest priority. (→P.399)

■ **Connecting manually**

When the auto connection has failed or “Bluetooth Power” is turned off, it is necessary to connect the Bluetooth® device manually.

- 1 Display the Bluetooth® settings screen. (→P.394)
- 2 Follow the steps in “Connecting a Bluetooth® device” from step 2. (→P.395)

#### ■ Reconnecting the Bluetooth® phone

If a Bluetooth® phone is disconnected due to poor reception from the Bluetooth® network when the engine switch is in ACC or ON, the system automatically reconnects the Bluetooth® phone.

#### ■ Registering a Bluetooth® device

Up to 5 Bluetooth® devices can be registered.

Bluetooth® compatible phones (HFP) and audio players (AVP) can be registered simultaneously.

This operation cannot be performed while driving.

- 1 Display the Bluetooth® settings screen. (→P.394)
- 2 Select “Add New Device”.
  - ▶ When another Bluetooth® device is connected
- To disconnect the Bluetooth® device, select “Yes”.

- ▶ When 5 Bluetooth® devices have already been registered
  - A registered device needs to be replaced. Select “Yes”, and select the device to be replaced.
- 3 Follow the steps in “Registering a Bluetooth® phone for the first time” from step 5. (→P.390)

#### ■ Deleting a Bluetooth® device

This operation cannot be performed while driving.

- 1 Display the Bluetooth® settings screen. (→P.394)
- 2 Select “Remove Device”.
- 3 Select the desired device.

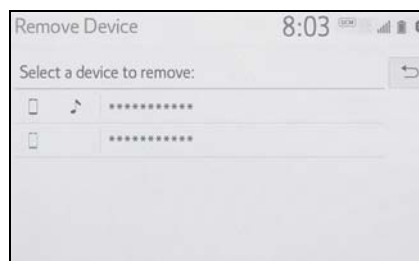

- 4 Select “Yes” when the confirmation screen appears.
- 5 Check that a confirmation screen is displayed when the operation is complete.

- When deleting a Bluetooth® phone, the contact data will be deleted at the same time.

### Editing the Bluetooth® device information

The Bluetooth® device's information can be displayed on the screen. The displayed information can be edited.

This operation cannot be performed while driving.

- 1 Display the Bluetooth® settings screen. (→P.394)
- 2 Select "Registered Device".
- 3 Select the desired device to be edited.
- 4 Select "Device Info".

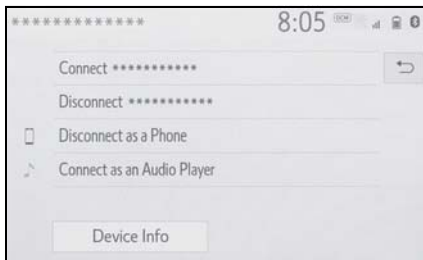

- 5 Confirm and change the Bluetooth® device information.



- A** The name of the Bluetooth® device is displayed. It can be changed to a desired name. (→P.399)
- B** Select to set the Bluetooth® audio player connection method. (→P.399)
- C** Device address is unique to the device and cannot be changed.
- D** Phone number is unique to the Bluetooth® phone and cannot be changed.
- E** Compatibility profile is unique to the Bluetooth® device and cannot be changed.
- F** Select to reset all setup items.

- If 2 Bluetooth® devices have been registered with the same device name, the devices can be distinguished referring to the device's address.
- Depending on the type of Bluetooth® phone, some information may not be displayed.

**Changing a device name**

- 1 Select "Device Name".
- 2 Enter the name and select "OK".

- Even if the device name is changed, the name registered in your Bluetooth® device does not change.

**Setting audio player connection method**

- 1 Select "Connect Audio Player From".
- 2 Select the desired connection method.



"Vehicle": Select to connect the audio player from the vehicle's audio/visual system.

"Device": Select to connect the vehicle's audio/visual system from the audio player.

- Depending on the audio

player, the "Vehicle" or "Device" connection method may be best. As such, refer to the manual that comes with the audio player.

**"Detailed Settings" screen**

The Bluetooth® settings can be confirmed and changed.

- 1 Display the Bluetooth® settings screen. (→P.394)
- 2 Select "Detailed Settings".
- 3 Select the desired item to be set.



- A** Select to set Bluetooth® connection on/off. (→P.400)
- B** Select to change the automatic connection priority of the registered Bluetooth® devices. (→P.400)
- C** Select to edit the system information. (→P.400)
- D** Select to reset all setup items.

### Changing “Bluetooth Power”

- 1 Select “Bluetooth Power”.

When “Bluetooth Power” is on:  
The Bluetooth® device is automatically connected when the engine switch is in ACC or ON.

When “Bluetooth Power” is off:  
The Bluetooth® device is disconnected, and the system will not connect to it next time.

- While driving, the auto connection state can be changed from off to on, but cannot be changed from on to off.

### Setting automatic connection priority

The automatic connection priority of the registered Bluetooth® devices can be changed.

- 1 Select “Preferred Device Settings”.
- 2 Select the desired item to be set.

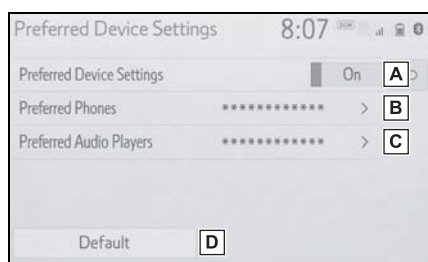

- A Select to set automatic connection priority on/off.
- B Select to change the auto-

matic connection priority of the registered Bluetooth® phones. (→P.400)

- C Select to change the automatic connection priority of the registered Bluetooth® audio players. (→P.400)
- D Select to reset all setup items.

### Changing Bluetooth® device automatic connection priority

- 1 Select “Preferred Phones” or “Preferred Audio Players”.
- 2 Select the desired Bluetooth® device and select “Move Up” or “Move Down” to change the preferred order.

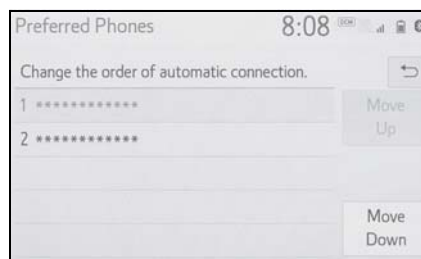

- A newly registered Bluetooth® device will automatically be given the highest automatic connection priority.

### Editing the system information

- 1 Select “System Information”.



- 2 Select the desired item to be set.



- A** Displays system name. Can be changed to a desired name. (→P.401)
- B** PIN code used when the Bluetooth<sup>®</sup> device was registered. Can be changed to a desired code. (→P.401)
- C** Device address is unique to the device and cannot be changed.
- D** Select to set the connection status display of the phone on/off.
- E** Select to set the connection status display of the audio player on/off.
- F** Compatibility profile of the system
- G** Select to reset all setup items.

#### ■ Editing the system name

- 1 Select "System Name".
- 2 Enter a name and select "OK".

#### ■ Editing the PIN code

- 1 Select "System PIN Code".
- 2 Enter a PIN code and select "OK".

**Wi-Fi® Hotspot\***

\*: Vehicles equipped with DCM only. This function is not made available in some countries or areas.

**By connecting a device to the vehicle via Wi-Fi®, it can access the internet through the DCM.**

- To use this function, a Wi-Fi® Hotspot service subscription from AT&T is required. Connect your device to the in-vehicle access point (see instructions below), or contact your Toyota dealer for details.

**Connecting a device to the in-vehicle access point****Searching for and connecting a device to the vehicle access point**

- 1 Enable the Wi-Fi® Hotspot function. (→P.403)
  - 2 Disable the “Hide Access Point” function. (→P.403)
  - 3 Search for the vehicle access point using the device you wish to connect.
- For details about operating the device, refer to the documentation which came with it.

- 4 Operate the device to connect it to the vehicle access point.

- To check the vehicle access point password, check “Password”. (→P.403)

- Hints for connecting to the vehicle via Wi-Fi® can be displayed. (→P.403)

**Connecting a device to the in-vehicle access point using the access point name (SSID)**

- 1 Enable the Wi-Fi® Hotspot function. (→P.403)
- 2 Enable the “Hide Access Point” function. (→P.403)
- 3 Enter the access point name (SSID) into the device you wish to connect and connect it.

- To check the vehicle access point password, check “Password”. (→P.403)
- The security settings on the device must be the same as that displayed for “Security”. (→P.403)
- For details about operating the device, refer to the documentation which came with it.

### Changing the Wi-Fi® settings

1 Press the “MENU” button.

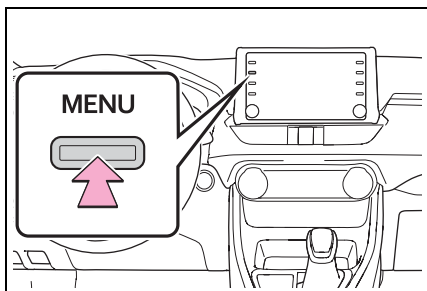

2 Select “Setup”.

3 Select “Wi-Fi”.

\*: Wi-Fi® is a registered trademark of Wi-Fi Alliance®.

4 Select the desired item to be set.

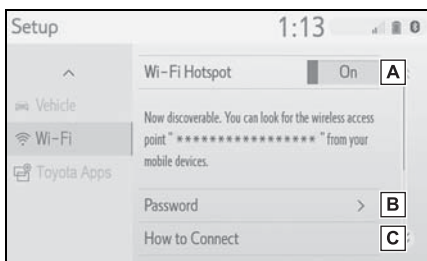

**A** Select to enable/disable the Wi-Fi® Hotspot function. (→P.403)

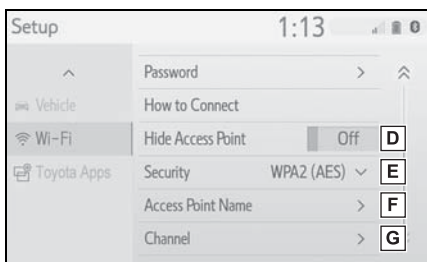

**B** Select to check/change the access point password. (→P.404)

**C** Select to display hints for connecting to the vehicle via Wi-Fi®.

**D** Select to make the access point searchable/unsearchable.

**E** Select to check/change the security protocol of the access point (for authentication and encryption). (→P.404)

**F** Select to change the access point name (SSID). (→P.404)

**G** Select to change the Wi-Fi® connection channel (within the 2.4GHz frequency band). (→P.404)

● If any settings have been changed, it will be necessary to reset the Wi-Fi® system to complete the changes. To reset the Wi-Fi® system, select “Yes” on the pop-up displayed after changing the settings.

### Enabling/disabling the Wi-Fi® Hotspot function

When the Wi-Fi® Hotspot function is enabled, the system checks for a valid Hotspot service subscription.

If a Hotspot service subscription has not been started, connect your device to the in-vehicle

access point to start your subscription. A trial subscription may be available.

Contact your Toyota dealer for details about the Toyota mobile application.

### Checking/changing the password

- 1 Select "Password".
- 2 Check that the following screen is displayed.

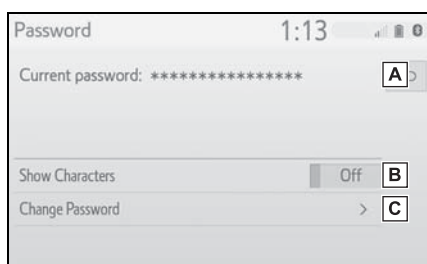

- A** Displays the password
- B** Select to display/hide the entered password.
- C** Select to change the password.

### Changing the password

- 1 Select "Change Password".
  - 2 Enter the desired password and select "OK".
- When setting/changing a password, observe the following guidelines to help prevent the password from being cracked by a third party:
    - Use an 8-character or longer

password consisting of letters and numbers. (Non-ASCII characters will not be recognized by the system.)

- Change the password regularly.
- If you write the password down, do not leave it somewhere where it would be visible.
- Do not use the same password for vehicle Wi-Fi® Hotspot as other accounts already protected by a password.
- Avoid using easy to identify words, such as your vehicle's model name or license plate number, simple dictionary words, or words with simple obfuscation, such as c@t (for cat), as your password.

### Changing the security protocol

- 1 Select "Security".
- 2 Select the desired security protocol.

### Changing the access point name (SSID)

- 1 Select "Access Point Name".
- 2 Enter the desired access point name (SSID) and select "OK".

### Selecting a Wi-Fi® connection channel

- 1 Select "Channel".

- 2 Check that the following screen is displayed.

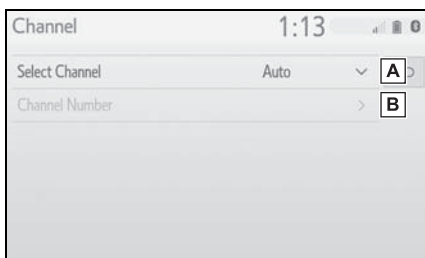

- A** Select to change the channel selection to auto-automatic/manual.
- B** When “Manual” is selected, select to change the channel.

#### Changing the channel

- 1 Set “Select Channel” to “Manual”.
  - 2 Select “Channel Number”.
  - 3 Enter the desired channel number and select “OK”.
- Channels 1 through 11 can be selected.

#### Wi-Fi® function operating hints

- If a connected device is taken out of the Wi-Fi® connection area, the connection will be severed.
- If the vehicle is driven out of the cellular communication coverage area, connecting to the internet via the Wi-Fi® Hotspot will not be possible.
- If a Bluetooth® device is used while a device is connected using

the Wi-Fi® Hotspot function, the communication speed may decrease.

- If the vehicle is near a radio antenna, radio station or other source of strong radio waves and electrical noise, communication may be slow or impossible.

#### ! WARNING

- Use Wi-Fi® devices only when safe and legal to do so.
- Your audio unit is fitted with W-Fi® antennas. People with implantable cardiac pacemakers, cardiac resynchronization therapy-pacemakers or implantable cardioverter defibrillators should maintain a reasonable distance between themselves and the Wi-Fi® antennas. The radio waves may affect the operation of such devices.
- Before using Wi-Fi® devices, users of any electrical medical device other than implantable cardiac pacemakers, cardiac resynchronization therapy-pacemakers or implantable cardioverter defibrillators should consult the manufacturer of the device for information about its operation under the influence of radio waves. Radio waves could have unexpected effects on the operation of such medical devices.

#### Conditions displayed with Wi-Fi® icon

The condition of Wi-Fi® connection appears on the right upper side of the screen. (→P.378)

### Specifications

- Communication standards
  - IEEE 802.11b
  - IEEE 802.11g
  - IEEE 802.11n (2.4GHz)
- Security
  - WPA™
  - WPA2™
- WPA™ and WPA2™ are trademarks of Wi-Fi Alliance®.

Apple Car-Play®/Android Auto\*

Apple CarPlay/Android Auto allows some applications, such as Map, Phone, and Music, to be used on the system.

When an Apple CarPlay/Android Auto connection is established, Apple CarPlay/Android Auto compatible applications will be displayed on the system display.

- Compatible device  
Apple iPhone (iOS Ver. 9.3 or later) that supports Apple CarPlay. For details, refer to <https://www.apple.com/ios/carplay/>.
- Android devices with Android OS ver 5.0 or higher which support Android Auto and have the Android Auto application installed. For details, refer to <https://www.android.com/auto/>.

\*: This function is not made available in some countries or areas.

Establishing an Apple CarPlay connection

- 1 Enable Siri on the device to be connected.

- 2 Connect the device to the USB port. (→P.422)
- 3 Select “Always Enable” or “Enable Once”.

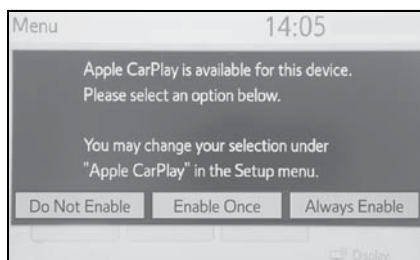

- 4 Press the “MENU” button.
- “Do Not Enable”: Select to not enable Apple CarPlay. Apple CarPlay will remain off until “Apple CarPlay” of “Projection Settings” on the general settings screen is turned on.
  - Depending on the device connected, it may take approximately 3 to 6 seconds before the system returns to previous screen.
  - The screen may change to step 6 depending on the system.

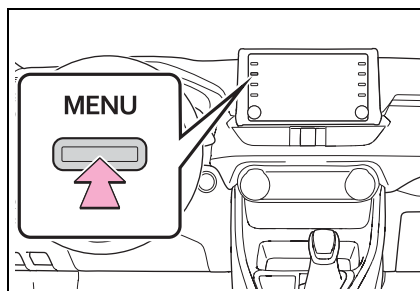

- 5 Select the “Apple CarPlay”.

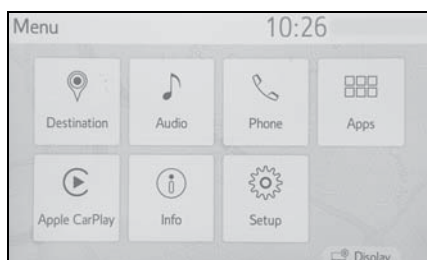

- 6 Check that home screen of Apple CarPlay is displayed.

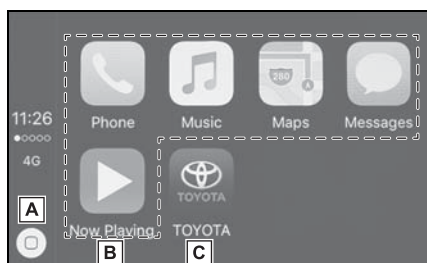

- A** Select to display the home screen of Apple CarPlay. Select and hold to activate Siri.
- B** Select to start the application. User can use any iPhone application supported by Apple CarPlay.
- C** Select to display the system screen.

### Establishing an Android Auto connection

- 1 Check that the Android Auto application is installed to the device to be connected.
- 2 Connect the device to the USB port. (→P.422)

- 3 Select “On” to enable the function.

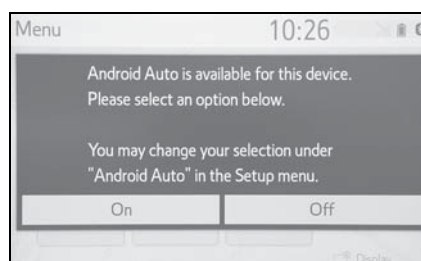

- “Off”: Select to not enable Android Auto. Android Auto will remain off until “Android Auto” of “Projection Settings” on the general settings screen is turned on.
- Depending on the device connected, it may take approximately 3 to 6 seconds before the system returns to previous screen.
- The screen may change to step 6 depending on the system.

- 4 Press the “MENU” button.

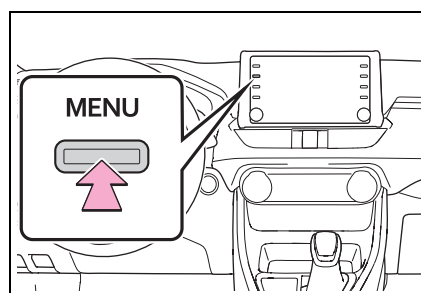



5 Select the “Android Auto”.

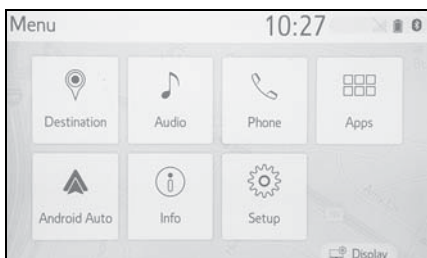

6 Check that home screen of Android Auto is displayed.

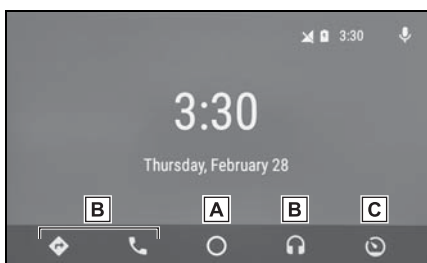

- A** Select to display the home screen of Android Auto.
- B** Select to start the application. User can use any Android application supported by Android Auto.
- C** Select to display the system screen.

- When an Apple CarPlay/Android Auto connection is established, the function of some system buttons will change.
- When an Apple CarPlay/Android Auto connection is established, some system functions, such as the following, will be replaced by similar Apple CarPlay/Android Auto functions or will become unavailable:
  - iPod (Audio Playback)
  - USB audio/USB video
  - Bluetooth® audio

- Bluetooth® phone (Apple CarPlay only)
- Toyota Apps
- When an Apple CarPlay/Android Auto connection is established, voice command system (Siri/Google Assistant) and map application voice guidance volume can be changed by selecting “Voice Volume” on the voice settings screen. It cannot be changed by “POWER VOLUME” knob on Audio control panel. (→P.418)
- Apple CarPlay/Android Auto is an application developed by Apple Inc/Google LLC. Its functions and services may be terminated or changed without notice depending on the connected device’s operation system, hardware and software, or due to changes in Apple CarPlay/Android Auto specifications.
- For a list of the apps supported by Apple CarPlay or Android Auto, refer to their respective website.
- While using these functions, vehicle and user information, such as location and vehicle speed, will be shared with the respective application publisher and the cellular service provider.
- By downloading and using each application, you agree to their terms of use.
- Data for these functions is transmitted using the internet and may incur charges. For information about data transmission fees, contact your cellular service provider.
- Depending on the application, certain functions, such as music playback, may be restricted.
- As the applications for each function are provided by a third-party, they may be subject to change or discontinuation without notice. For details, refer to the website of the function.
- If the vehicle’s navigation system

is being used for route guidance and a route is set using the Apple CarPlay/Android Auto Maps app, route guidance will be performed through Apple CarPlay/Android Auto. If the Apple CarPlay/Android Auto Maps app is being used for route guidance and a route is set using the vehicle's navigation system, route guidance will be performed by the vehicle's navigation system.

- If the USB cable is disconnected, operation of Apple CarPlay/Android Auto will end. At this time, sound output will stop and change to the system screen.

#### ■ Certification



- Use of the Apple CarPlay logo means that a vehicle user interface meets Apple performance standards. Apple is not responsible for the operation of this vehicle or its compliance with safety and regulatory standards. Please note that the use of this product with iPhone or iPod may affect wire-

less performance.

- Apple CarPlay is a trademark of Apple Inc.



- Android and Android Auto are trademarks of Google LLC.

#### ⚠ WARNING

- Do not connect iPhone or operate the controls while driving.

#### ⚠ NOTICE

- Do not leave your smartphone in the vehicle. In particular, high temperatures inside the vehicle may damage the smartphone.
- Do not push down on or apply unnecessary pressure to the smartphone while it is connected as this may damage the smartphone or its terminal.
- Do not insert foreign objects into the port as this may damage the smartphone or its terminal.

## Troubleshooting

If you are experiencing difficulties with Apple CarPlay/Android Auto, check the following table.

Symptom	Solution
An Apple CarPlay/Android Auto connection cannot be established.	<p>Check if the device supports Apple CarPlay/Android Auto.</p> <p>Check if Apple CarPlay/Android Auto is enabled on the connected device.</p> <p>Check that the Android Auto application is installed to the device to be connected.</p> <p>For details, refer to <a href="https://www.apple.com/ios/carplay/">https://www.apple.com/ios/carplay/</a>, <a href="https://www.android.com/auto/">https://www.android.com/auto/</a>.</p>
	<p>Check if “Apple CarPlay”/“Android Auto” of “Projection Settings” on the general settings screen is set to on. (→P.414)</p>
	<p>Check if the USB cable being used is securely connected to the device and USB port.</p> <p>Try connecting the smartphone directly to the USB port in the vehicle, without using the hub.</p> <p>For Apple CarPlay: Check if the Lightning cable being used is certified by Apple and check if Siri is enabled.</p>
	<p>After checking all of the above, try to establish an Apple CarPlay/Android Auto connection. (→P.407)</p>
When an Apple CarPlay/Android Auto connection is established and a video is being played, the video is not displayed, but audio is output through the system.	As the system is not designed to play video through Apple CarPlay/Android Auto, this is not a malfunction.
Although an Apple CarPlay/Android Auto connection is established, audio is not output through the system.	The system may muted or the volume may be low. Increase the system volume.

Symptom	Solution
The Apple CarPlay/Android Auto screen has artifacts and/or audio from Apple CarPlay/Android Auto has noise.	<p>Check if the USB cable being used to connect the device to the system is damaged. To check if the USB cable is damaged internally, connect the device to another system, such as a PC, and check if the device is recognized by the connected system. (The device should begin charging when connected.)</p> <p>After checking all of the above, try to establish an Apple CarPlay/Android Auto connection. (→P.407)</p>
The map display of the Apple CarPlay Maps app cannot be enlarged or contracted with pinch multi-touch gestures.	As the Apple CarPlay Maps app is not compatible with pinch multi-touch gestures, this is not a malfunction.
During Apple CarPlay music application (Apple Music, Spotify, etc.) playback, if the iPhone is operated to start and play audio from an application that is not compatible with Apple CarPlay* and the onboard device volume is changed, the audio of the incompatible application stops and the system resumes playback of the original music application.	This operation is performed according to the specification of the onboard device, this is not a malfunction.
After interrupt audio (such as navigation route guidance) is played from an application that is not compatible with Apple CarPlay while the onboard device is playing audio (FM/AM, CD, etc.), the system does not resume playback of the original audio (FM/AM, CD, etc.).	This operation is performed according to the specification of the onboard device, this is not a malfunction. Manually change the audio source by yourself. Or, do not use applications that are not compatible with Apple CarPlay.* Due to some navigation applications are compatible from iOS 12, update to the latest iOS and application versions.

Symptom	Solution
When using Apple CarPlay, route guidance arrows and turn by turn navigation are not displayed on the multi-information display and system display. When using Android Auto, turn by turn navigation is not displayed on the multi-information display and system display.	This is not a malfunction as display of these items is not possible with this function.
When using Android Auto, hands-free call audio cannot be heard from the vehicle's speakers.	Disconnect the phone from the USB cable and check if hands-free call audio can be heard using the hands-free system.
	Connect the phone to the system using Android Auto, turn up the volume on the system and check if hands-free call audio can be heard. Check if other sounds can be heard from the vehicle's speakers.

\*: Applications not compatible with Apple CarPlay are applications installed on the iPhone that are not displayed on the Apple CarPlay screen application list. (such as visual voicemail)

## General settings

Settings are available for clock, operation sounds, etc.

### Displaying the general settings screen

- 1 Press the "MENU" button.

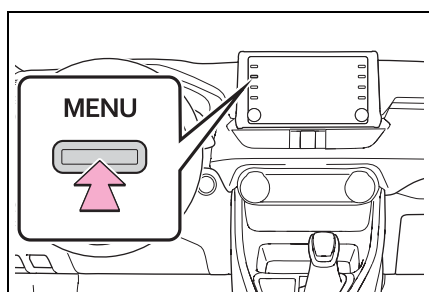

- 2 Select "Setup".

- If the general settings screen is not displayed, select "General".

- 3 Select the desired items to be set.

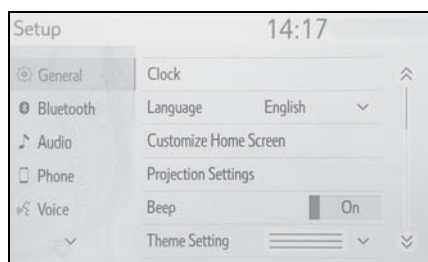

### General settings screen

- "Clock"

Select to change the time zone and select "On" or "Off" for daylight saving time, automatic adjustment of

the clock, etc. (→P.415)

- "Language"

Select to change the language. The language setting of Apple CarPlay/Android Auto can only be changed on the connected device.

- "Customize Home Screen"

Select to change the display information/area on the home screen and the home screen layout. (→P.384)

- "Projection Settings"\*1

Select to set automatic Apple CarPlay/Android Auto connection establishment on/off. (→P.416)

- "Beep"

Select to turn the beep sound on/off.

- "Theme Setting"

Select to change the screen theme setting.

- "Units of Measurement"

Select to change the unit of measure for distance/fuel consumption.

- "Keyboard Layout"

Select to change the keyboard layout.

- "Delete Keyboard History"

Select to delete the keyboard history.

- "Memorize Keyboard History"

Select to set the memorize keyboard history on/off.

- "Animation"

Select to turn the animations on/off.

- "Driver Setting"

Select to change the driver settings. (→P.416)

- “Delete Personal Data”

Select to delete personal data. (→P.417)

- “Software Update”

Select to update software versions. For details, contact your Toyota dealer.

- “Software Update Setting”<sup>\*2</sup>

Select to set software update setting. (→P.417)

- “Gracenote Database Update”

Select to update Gracenote® database versions. For details, contact your Toyota dealer.

- “Software Information”

Select to display the software information. Notices related to third party software used in this product are enlisted. (This includes instructions for obtaining such software, where applicable.)

- “SW Sensitivity Level”

Select to change the capacitive touch screen button sensitivity to 1 (low), 2 (medium), or 3 (high).

<sup>\*1</sup>: This function is not made available in some countries or areas.

<sup>\*2</sup>: Vehicles equipped with DCM

### Clock settings

- 1 Display the general settings screen. (→P.414)
- 2 Select “Clock”.

- 3 Select the desired items to be set.

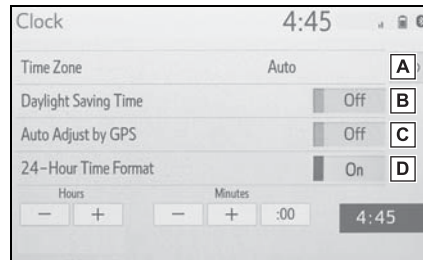

- A** Select to change the time zone. (→P.415)
- B** Select to set daylight saving time on/off.
- C** Select to set automatic adjustment of the clock by GPS on/off. When set to off, the clock can be manually adjusted. (→P.415)
- D** Select to set the 24 hour time format on/off. When set to off, the clock is displayed in 12 hour time format.

#### Setting the time zone

- 1 Select “Time Zone”.
- 2 Select the desired time zone.

#### Manual clock setting

When “Auto Adjust by GPS” is turned off, the clock can be manually adjusted.

- 1 Select “Auto Adjust by GPS” to set to off.

## 2 Adjust the clock manually.

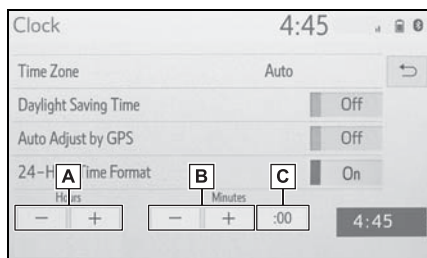

- A** Select “+” to set the time forward one hour and “-” to set the time back one hour.
- B** Select “+” to set the time forward one minute and “-” to set the time back one minute.
- C** Select to round to the nearest hour.  
e.g.  
1:00 to 1:29 → 1:00  
1:30 to 1:59 → 2:00

**Projection settings\***

\*: This function is not made available in some countries or areas.

- 1 Display the general settings screen. (→P.414)
- 2 Select “Projection Settings”.
- 3 Select the desired items to be set.

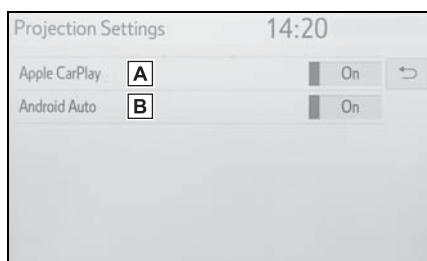

**A** Select to turn Apple CarPlay connection establishment on/off.

**B** Select to turn Android Auto connection establishment on/off.

- When the settings are changed with a device connected to the system via USB, disconnect the device and connect it again to enable the settings.

**Driver settings**

The driver settings feature will allow the system to link some preferences (such as audio presets, screen theme, language, etc.) to a paired Bluetooth® phone.

- 1 Display the general settings screen. (→P.414)
- 2 Select “Driver Setting”.
- 3 Select “Enable This Feature”.

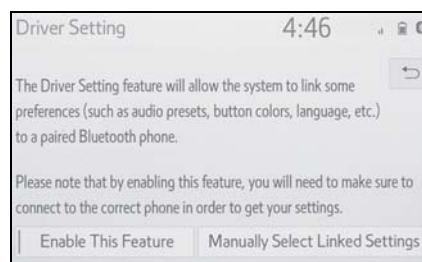
**Manually select linked settings**

- 1 Select “Manually Select Linked Settings”.



- 1 Select the desired phone.

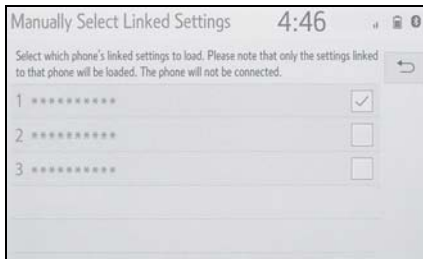

- After a few seconds, loaded screen automatically switches to the home screen.

### Deleting personal data

Registered or changed personal settings will be deleted or returned to their default conditions.

- 1 Display the general settings screen. (→P.414)
- 2 Select “Delete Personal Data”.
- 3 Select “Delete”.
- 4 Select “Yes” when the confirmation screen appears.

Examples of settings that can be returned to their default conditions:

- Audio settings
  - Phone settings
- etc.

### Software update settings\*

\*: Vehicles equipped with DCM only. This function is not made available in some countries or areas.

When the automatic update

check function is enabled, if a software update is available from the Cloud, a message will be displayed.

- 1 Display the general settings screen. (→P.414)
- 2 Select “Software Update Setting”.
- 3 Select “Automatic Update Check” to enable/disable the automatic update check function.

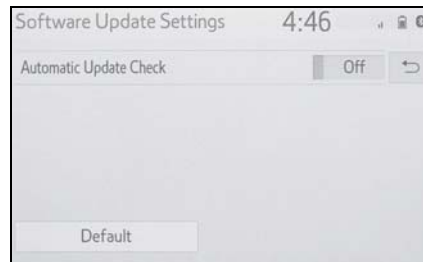

- When software update information is displayed, contact your Toyota dealer.

5

Audio

### Voice settings

Voice volume, etc. can be set.

### Displaying the voice settings screen

- 1 Press the "MENU" button.

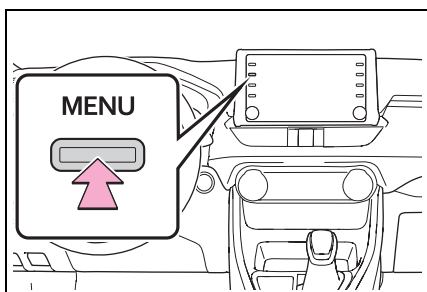

- 2 Select "Setup".
- 3 Select "Voice".
- 4 Select the desired items to be set.

### Voice settings screen

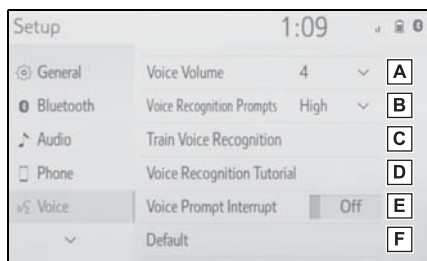

- A** Select to adjust the volume of voice guidance.\*
- B** Select to set the voice recognition prompts.
- C** Select to train voice recogni-

tion.

The voice command system adapts the user accent.

- D** Select to start the voice recognition tutorial.
- E** Select to set the voice prompt interrupt on/off.
- F** Select to reset all setup items.

\*: When an Apple CarPlay/Android Auto connection is established, voice command system (Siri/Google Assistant) and map application voice guidance volume can be changed.

## Vehicle settings

Settings are available for vehicle customization, etc.

### Displaying the vehicle settings screen

- 1 Press the "MENU" button.

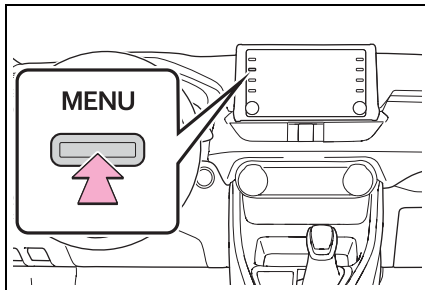

- 2 Select "Setup".
- 3 Select "Vehicle".
- 4 Select the desired items to be set.

### Vehicle settings screen

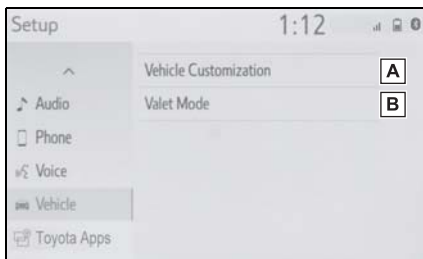

- A** Select to set vehicle customization. (→P.688)
- B** Select to set valet mode. (→P.419)

### Setting the valet mode

The security system can be set to on by entering a security code (4-digit number).

When set to on, the system will become inoperative once the electrical power source is disconnected until the security code is entered.

- 1 Display the vehicle settings screen. (→P.419)
- 2 Select "Valet Mode".
- 3 Enter the 4-digit personal code and select "OK".
- 4 Enter the same 4-digit personal code again and select "OK".

- The system will request that you input the security code again to confirm that you remember it correctly.
- When valet mode activates, the system stops and a security code (4-digit number) standby screen is displayed.

- If the 4-digit personal code is forgotten, please contact your Toyota dealer.

### If the valet mode has been activated

- 1 Enter the 4-digit personal code and select "OK".
- If an incorrect security code (4-digit number) is entered 6 times, the system will not accept another security code (4-digit number) for 10 minutes.

## Quick reference

## Functional overview

The audio control screen can be reached by the following methods:

- ▶ From the “AUDIO” button
  - 1 Press the “AUDIO” button.
- ▶ From the “MENU” button
  - 1 Press the “MENU” button, then select “Audio”.

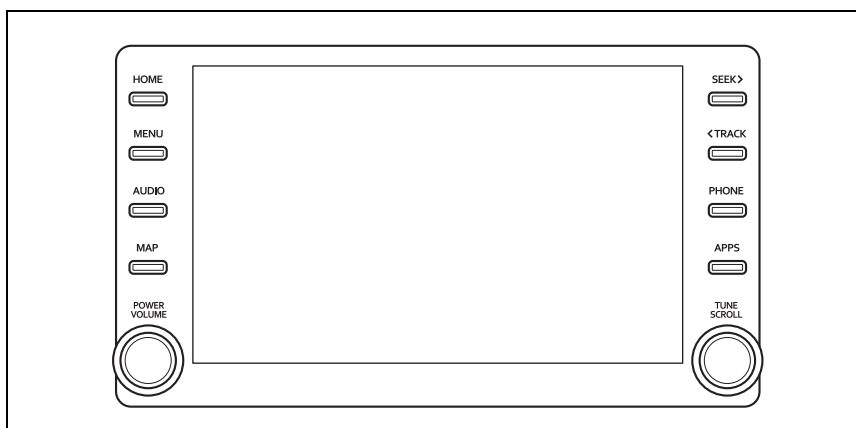

- Using the radio (→P.425)
- Playing a USB memory (→P.432)
- Playing an iPod/iPhone (Apple CarPlay<sup>\*</sup>) (→P.434)
- Using the Android Auto<sup>\*</sup> (→P.437)
- Playing a Bluetooth<sup>®</sup> device (→P.438)
- Using the steering wheel audio switches (→P.442)
- Audio system settings (→P.444)

\*: This function is not made available in some countries or areas.

Some basics

**This section describes some of the basic features of the audio/visual system. Some information may not pertain to your system. Your audio/visual system works when the engine switch is in ACC or ON.**

 NOTICE

- To prevent the battery from being discharged, do not leave the audio/visual system on longer than necessary when the engine is not running.

Turning the system on and off

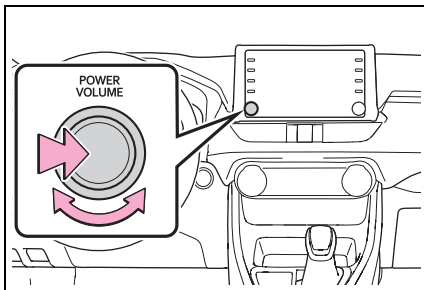

**“POWER VOLUME” knob:**  
Press to turn the audio/visual system on and off. The system turns on in the last mode used. Turn this knob to adjust the volume.

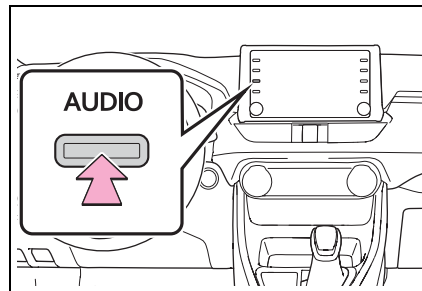

Selecting an audio source

- 1 Press the “AUDIO” button.

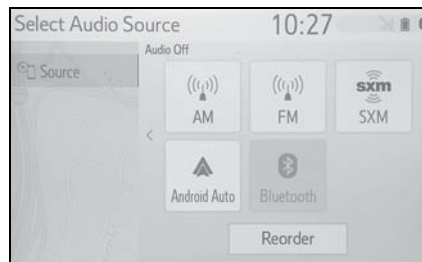

- 2 Select “Source” or press “AUDIO” button again.
- 3 Select the desired source.



- Dimmed screen buttons cannot be operated.
- When there are two pages, select  or  to change the page.
- When an Apple CarPlay/Android Auto connection is established, some system functions, such as the following, will be replaced by similar Apple CarPlay/Android Auto function or will become unavailable\* :
  - iPod (Audio Playback)
  - USB audio/USB video
  - Bluetooth® audio
  - Toyota Apps

\*: This function is not made available in some countries or areas.

### Reordering the audio source

- 1 Display the audio source selection screen. (→P.421)
- 2 Select “Reorder”.
- 3 Select the desired audio source then **<** or **>** to reorder.
- 4 Select “OK”.

### USB port

- 1 Connect a device.

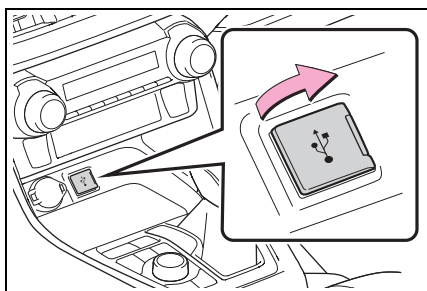

- Turn on the power of the device if it is not turned on.
- If a USB hub is plugged-in, two devices can be connected at a time.
- Even if a USB hub is used to connect more than two USB devices, only the first two connected devices will be recognized.
- If a USB hub that has more than two ports is connected to the USB port, devices connected to the USB hub may not charge or be inoperable, as the supply of current may be insufficient.
- When an Apple CarPlay/Android Auto connection is established, the other USB port can be used only for device battery charger.

### Sound settings

- 1 Display the audio control screen. (→P.421)
- 2 Select “Sound”.
- 3 Select the desired item to be set.

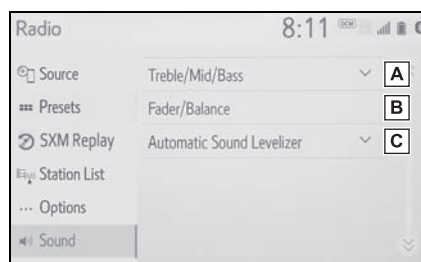

- A** Select to set the treble/mid/bass. (→P.422)
- B** Select to set the fader/balance. (→P.423)
- C** Select to set the automatic sound leveliser. (→P.423)

#### ■ Treble/Mid/Bass

How good an audio program sounds is largely determined by the mix of the treble, mid and bass levels. In fact, different kinds of music and vocal programs usually sound better with different mixes of treble, mid and bass.

- 1 Select “Treble/Mid/Bass”.

- 2 Select the desired screen button.

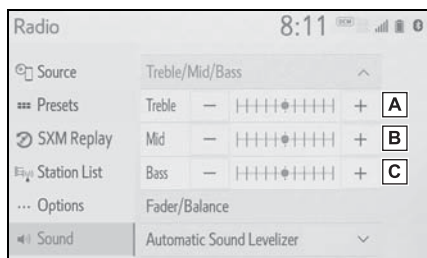

- A** Select “+” or “-” to adjust high-pitched tones.
- B** Select “+” or “-” to adjust mid-pitched tones.
- C** Select “+” or “-” to adjust low-pitched tones.

■ **Fader/Balance**

A good balance of the left and right stereo channels and of the front and rear sound levels is also important.

Keep in mind that when listening to a stereo recording or broadcast, changing the right/left balance will increase the volume of 1 group of sounds while decreasing the volume of another.

- 1 Select “Fader/Balance”.

- 2 Select the desired screen button.

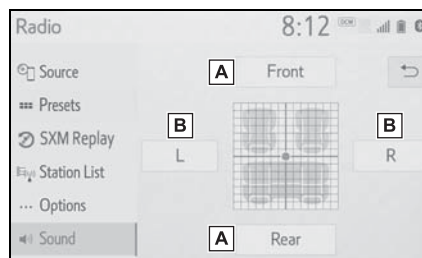

- A** Select to adjust the sound balance between the front and rear speakers.
- B** Select to adjust the sound balance between the left and right speakers.

■ **Automatic sound levelizer (ASL)**

The system adjusts to the optimum volume and tone quality according to vehicle speed to compensate for increased road noise, wind noise, or other noises while driving.

- 1 Select “Automatic Sound Levelizer”.
- 2 Select “High”, “Mid”, “Low” or “Off”.

**Audio screen adjustment**

■ **Screen format settings**

The screen format can be selected for USB video.

- 1 Press the “MENU” button.
- 2 Select “Setup”.
- 3 Select “Audio”.

- 4 Select "Common".
- 5 Select "Screen Format".
- 6 Select the desired item to be adjusted.

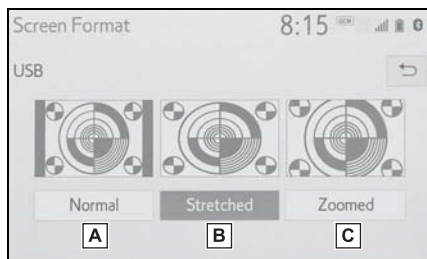

- A** Select to display a 4 : 3 screen, with either side in black.
- B** Select to enlarge the image horizontally and vertically to full screen.
- C** Select to enlarge the image by the same ratio horizontally and vertically.

■ **Contrast and brightness adjustment**

The contrast and brightness of the screen can be adjusted.

- 1 Press the "MENU" button.
- 2 Select "Setup".
- 3 Select "Audio".
- 4 Select "Common".
- 5 Select "Display".
- 6 Select the desired item to be adjusted.

● "Contrast"

"+": Select to strengthen the contrast of the screen.

"-": Select to weaken the contrast of

the screen.

● "Brightness"

"+": Select to brighten the screen.

"-": Select to darken the screen.

- Depending on the audio source, some functions may not be available.

**Voice command system**

- 1 Press this switch to operate the voice command system.

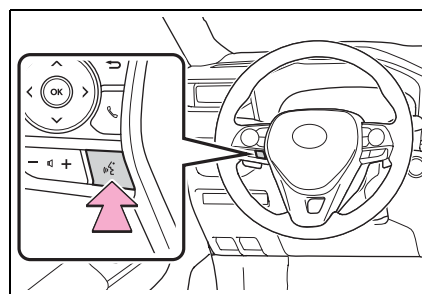

- The voice command system and its list of commands can be operated. (→P.458)



**AM/FM/SiriusXM (SXM) radio\***

\*: This function is not made available in some countries or areas.

**Overview**

The radio operation screen can be reached by the following methods:  
→P.421

**Control screen**

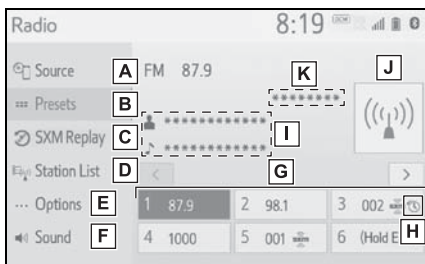

- A** Select to display the audio source selection screen.
- B** Select to display the preset stations screen. (→P.426)
- C** Select to display the cache radio operation screen. (→P.426)
- D** Select to display a list of receivable stations. (→P.427)
- E** Select to display the radio options screen. (→P.427)
- F** Select to display the sound setting screen. (→P.422)
- G** Select to tune to preset stations/channels. (→P.426)

- H** Displays items on the channels registered to smart favorites\* (→P.430, 445)
- I** Displays the artist info and song title or album  
Select to change the displayed information.  
Displays messages when available\*
- J** Displays cover art, station logo, etc.\*
- K** Displays information about the song/track currently being played\*

\*: This function is not made available in some countries or areas.

**Control panel**

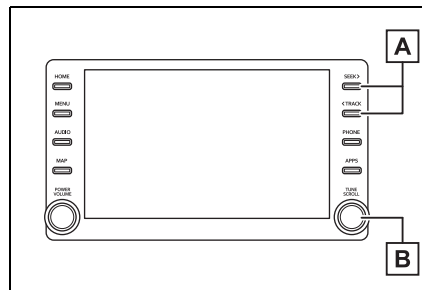

- A** Press to seek for stations in the relevant program type/channel category.  
Press and hold for continuous seek.
- B** Turn to step up/down frequencies/channels.  
Turn to move up/down the station list. Also, the knob can be used to enter selec-

tions on the list screens by pressing it.

- The radio automatically changes to stereo reception when a stereo broadcast is received.

### Presetting a station

Radio mode has a mix preset function, which can store up to 36 stations (6 stations per page x 6 pages) from any of the AM, FM or SXM\* bands.

- 1 Tune in the desired station.
- 2 Select and hold “(Hold Edit)”.

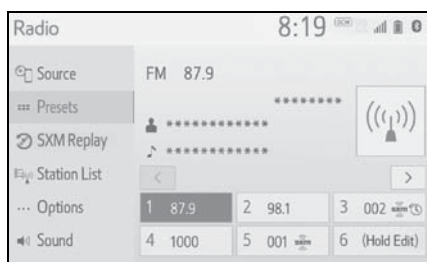

- When “(Hold Edit)” is selected, a confirmation message appears. Select “Yes” and select “OK”.
- To change the preset station to a different one, select and hold the preset station.

\*: This function is not made available in some countries or areas.

- The number of preset radio stations displayed on the screen can be changed. (→P.444)

### Caching a radio program\*

\*: This function is not made avail-

able in some countries or areas.

AM/FM and SXM radio program can be cached and played back in a time-shifted manner.

#### Automatic playback of the cache

If the radio broadcast is interrupted by another audio output, such as an incoming phone call, the system will automatically cache the interrupted portion and perform time-shift playback when the interruption ends. This function is available when “Auto Pause” is set to on. (→P.427)

#### Playing back the cache manually

The broadcast cached in the program cache can be played back manually.

- 1 Select “SXM Replay”.
- 2 Select the desired cache radio operation button.

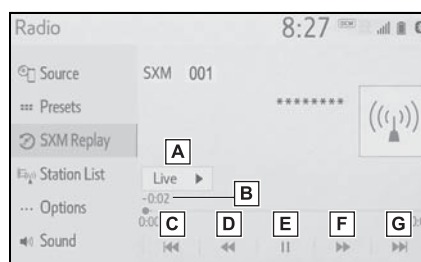

- A** Returns to the live radio broadcast
- B** Displays the replay offset from the current time
- C** Skips backward 2 minutes (AM/FM)

Select to select current/previous track (SXM)

- D** Fast rewinds continuously
- E** Pauses the playback (To restart, select )
- F** Fast forwards continuously
- G** Skips forward 2 minutes (AM/FM)  
Select to change the track (SXM)

- The system can store up to 20 minutes of AM/FM and less than 60 minutes of SXM. Cached data will be erased when the radio mode or station is changed or when the audio system is turned off.
- AM/FM: If noise or silence occurs during the caching process, cache writing will continue, with the noise or silence recorded as is. In this case, the cached broadcast will contain the noise or silence when played back.

### Selecting a station from the list

- 1 Select "Station List".
- 2 Select "AM", "FM" or "SXM\*".
- Select the desired program genre when the genre selection screen is displayed.
- 3 Select the desired station.

\*: This function is not made available in some countries or areas.

### Refreshing the station list (AM/FM)

- 1 Select "Station List".

"Cancel Refresh": Select to cancel the refresh.

"Source": Select to change to another audio source while refreshing.

- The audio/visual system sound is muted during refresh operation.
- In some situations, it may take some time to update the station list.

### Radio options

- 1 Select "Options".
- 2 Select the desired item to be set.

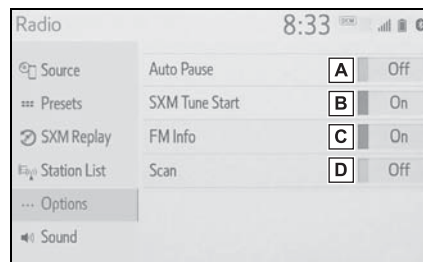

- A** Select to turn automatic playback of the cache on/off.\*
- B** When "SXM Tune Start" is turned on, the current song is played from the beginning when you select the channel.\*
- C** Analog FM only: Select to display RBDS text messages.
- D** Select to scan for receivable stations. (Type scan in case SXM\* is current program type/channel category.)

\*: This function is not made available in some countries or areas.

### **Radio broadcast data system**

This audio/visual system is equipped with Radio Broadcast Data Systems (RBDS). RBDS mode allows text messages to be received from radio stations that utilize RBDS transmitters.

When RBDS is on, the radio can do the following functions.

- Only selecting stations of a particular program type
- Displaying messages from radio stations
- Searching for a stronger signal station

RBDS features are available only when listening to an FM station that broadcasts RBDS information and the "FM Info" function is on. (→P.427)

### **How to subscribe to SiriusXM Radio Services \***

\*: This function is not made available in some countries or areas.

All SiriusXM services, including satellite radio and data services, plus streaming services, require a subscription, sold separately or as a package by Sirius XM Radio Inc. (or, in Canada, Sirius XM Canada Inc.), after any trial subscription which may be

included with your vehicle purchase or lease. To subscribe after your trial subscription, call 1-877-447-0011 (U.S.A.) or 1-877-438-9677 (Canada).

### **■ Important information about your subscription**

Your SiriusXM services will automatically stop at the end of your trial unless you decide to subscribe. If you decide to continue service, the paid subscription plan you choose will automatically renew and you will be charged the rate in effect at that time and according to your chosen payment method. Fees and taxes apply. You may cancel at any time by calling 1-866-635-2349. See SiriusXM Customer Agreement for complete terms at [www.siriusxm.com](http://www.siriusxm.com) (U.S.A.) or [www.siriusxm.ca](http://www.siriusxm.ca) (Canada). All fees and programming subject to change. Traffic information not available in all markets.

 **NOTICE**

- It is prohibited to copy, decompile, disassemble, reverse engineer, hack, manipulate, or otherwise make available any technology or software incorporated in receivers compatible with the SiriusXM Satellite Radio System or that support the SiriusXM website, the streaming service or any of its content. Furthermore, the AMBE<sup>®</sup> voice compression software included in this product is protected by intellectual property rights including patent rights, copyrights, and trade secrets of Digital Voice Systems, Inc.
- Note: this applies to SiriusXM Satellite Radio receivers only and not SiriusXM Ready devices.

- **ABOUT SiriusXM Services**
  - Most in-car trials today include SiriusXM's best package — All Access. It includes every channel available on your radio, plus streaming.
- **SiriusXM All Access Subscription**
  - Listen everywhere with All Access. You get every channel available in your ride, plus you can listen on the app and online — so you can enjoy the best SiriusXM has to offer, anywhere life takes you. It's the only package that gives you all of our premium programming, including Howard Stern, every NFL, MLB<sup>®</sup> and NBA game, every NASCAR<sup>®</sup> race, NHL<sup>®</sup> games, 24/7 talk channels dedicated to the biggest leagues, and more. You get all kinds of commercial-free music, including artist-dedicated channels and more, plus sports, news, talk and entertainment.

Did you know? SiriusXM also delivers a wide variety of services to certain vehicles' entertainment and navigation systems such as Traffic, Weather, Sports Scores, Movie Listings, Fuel Prices, Stock Prices and more. For a list of available features in your vehicle, visit [siriusxm.com/infotainment](http://siriusxm.com/infotainment) and get the most out of your driving experience.

- **RADIO OPERATION**
  - Look for the Sirius, XM, SiriusXM, Band, SAT, AUX, Radio or Source button and you're in. If you can't hear us, it's easy to get started: Locate your Radio ID by turning to Channel 0. If you don't see your number there, go to [siriusxm.com/activationhelp](http://siriusxm.com/activationhelp) to find it. Visit [siriusxm.com/refresh](http://siriusxm.com/refresh) or call 1-855-MYREFRESH (697-3373) to send a refresh signal to your radio.  
Canadian Customers: Locate your Radio ID by turning to Channel 0. Visit [siriusxm.ca/refresh](http://siriusxm.ca/refresh) to send a refresh signal to your radio or call 1-888-539-7474 for service.

**Displaying the radio ID\***

- \* This function is not made available in some countries or areas.
- Each SiriusXM tuner is identified with a unique radio ID. The radio ID is required when activating an SiriusXM Satellite service or when reporting a problem.
- If "Ch 000" is selected using the "TUNE SCROLL" knob, the ID code, which is 8 alphanumeric characters, will be displayed. If another channel is selected, the ID code will no longer be displayed. The

channel (000) alternates between displaying the radio ID and the specific radio code.

### Smart favorites\*

\*: This function is not made available in some countries or areas.

Up to 20 channels can be registered as presets in the cache.

For channel registration, refer to (→P.444).

- 1 Select channels registered to smart favorites.

- 2 Select "SXM Replay".

- Caches up to 30 minutes for each Smart Favorite preset.
- The radio plays the track from start when that track has not previously been heard by the user and the station is registered as a smart favorite.
- When "SXM Tune Start" is turned on (→P.427), the current song is played from the beginning when you select the channel.
- Displays icons on the channels registered to smart favorites. (→P.425)

### Refer to the table below to identify the problem and take the suggested corrective action

When problems occur with the SiriusXM tuner, a message will appear on the screen. Referring to the table below to identify the problem, take the suggested corrective action\*.

\*: This function is not made available in some countries or areas.

Message	Explanation
"Check Antenna"	The SiriusXM antenna is not connected. Check whether the SiriusXM antenna cable is attached securely. Contact your Toyota dealer for assistance.
	A short circuit occurs in the antenna or the surrounding antenna cable. Contact your Toyota dealer for assistance.
"No Signal"	The SiriusXM signal is too weak at the current location. Wait until your vehicle reaches a location with a stronger signal.
"Chan Unavailable"	The channel you selected is not broadcasting any programming. Select another channel.

Message	Explanation
“Ch Unsubscribed”	The channel you selected is no longer available. Wait for about 2 seconds until the radio returns to the previous channel or “Ch 001”. If it does not change automatically, select another channel.
“Subscription Updated”	Subscription is updated. Select “OK” to clear this message.

- Contact the SiriusXM Listener Care Center at 1-877-447-0011 (U.S.A.) or 1-877-438-9677 (Canada).

## USB memory

### Overview

The USB memory operation screen can be reached by the following methods: →P.421

- Connecting a USB memory (→P.422)
- When an Apple Car-Play/Android Auto connection is established, this function will be unavailable.

### Control screen

#### ▶ USB audio

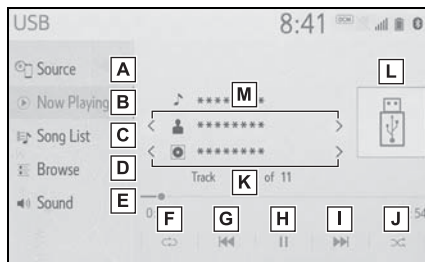

- A** Select to display the audio source selection screen.
- B** Select to return to the top screen.
- C** Select to display a song list screen.
- D** Select to display the play mode selection screen.
- E** Select to display the sound setting screen. (→P.422)
- F** Select to set repeat playback. (→P.433)

- G** Select to change the file/track.  
Select and hold to fast rewind.
- H** Select to play/pause.
- I** Select to change the file/track.  
Select and hold to fast forward.
- J** Select to set random playback. (→P.433)
- K** Select to change the folder/album.
- L** Displays cover art
- M** Select to change the artist.

#### ▶ USB video

- 1 Select "Browse".
- 2 Select "Videos".
- 3 Select the desired folder and file.

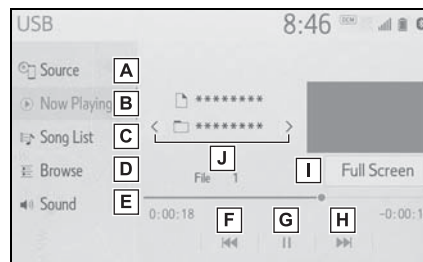

- A** Select to display the audio source selection screen.
- B** Select to return to the top screen.
- C** Select to display a song list screen.
- D** Select to display the play



mode selection screen.

- E** Select to display the sound setting screen. (→P.422)
- F** Select to change the file. Select and hold to fast rewind.
- G** Select to play/pause.
- H** Select to change the file. Select and hold to fast forward.
- I** Select to display a full screen image.
- J** Select to change the folder.

**Control panel**

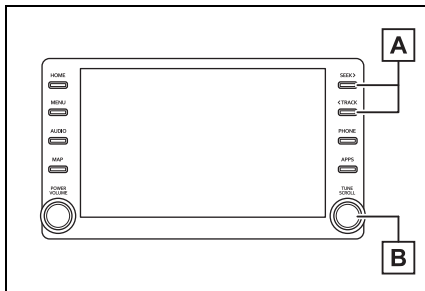

- A** Press to change the file/track. Press and hold to fast forward/rewind.
- B** Turn to change the file/track. Turn to move up/down the list. Also, the knob can be used to enter selections on the list screens by pressing it.

- While the vehicle is being driven, this function can only output sound.

- If tag information exists, the file/folder names will be changed to track/album names.

**Repeating**

The file/track or folder/album currently being listened to can be repeated.

- 1 Select .

- Each time  is selected, the mode changes as follows:
  - ▶ When random playback is off
    - file/track repeat → folder/album repeat → off
  - ▶ When random playback is on
    - file/track repeat → off

**Random order**

Files/tracks or folders/albums can be automatically and randomly selected.

- 1 Select .

- Each time  is selected, the mode changes as follows:
  - random (1 folder/album random) → folder/album random (all folder/album random) → off

**WARNING**

- Do not operate the player's controls or connect the USB memory while driving.

**NOTICE**

- Do not leave your portable player in the car. In particular, high temperatures inside the vehicle may damage the portable player.

 NOTICE

- Do not push down on or apply unnecessary pressure to the portable player while it is connected as this may damage the portable player or its terminal.
- Do not insert foreign objects into the port as this may damage the portable player or its terminal.

### iPod/iPhone (Apple CarPlay\*)

\*: This function is not made available in some countries or areas.

#### Overview

The iPod/iPhone operation screen can be reached by the following methods: →P.421

- Connecting an iPod/iPhone (→P.422)
- When an Android Auto connection is established, this function will be unavailable.

#### Control screen

- ▶ An Apple CarPlay connection is not established

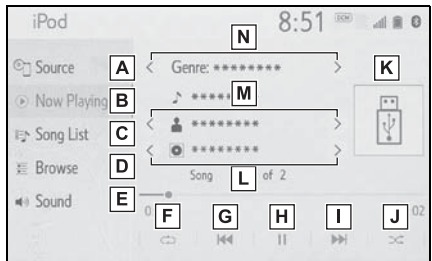

- ▶ An Apple CarPlay connection is established

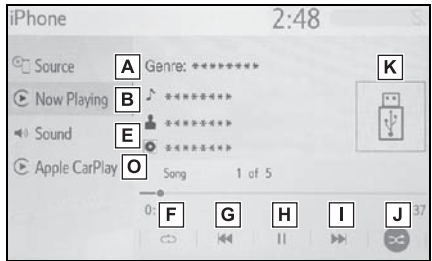

**A** Select to display the audio

source selection screen.

- B** Select to return to the top screen.
- C** Select to display a song list screen.
- D** Select to display the play mode selection screen.
- E** Select to display the sound setting screen. (→P.422)
- F** Select to set repeat playback. (→P.436)
- G** Select to change the track. Select and hold to fast rewind.
- H** Select to play/pause.
- I** Select to change the track. Select and hold to fast forward.
- J** Select to set random playback. (→P.436)
- K** Displays cover art
- L** Select to change the album.
- M** Select to change the artist.
- N** Select to change the playlist.
- O** Select to display the Apple CarPlay screen.

### Control panel

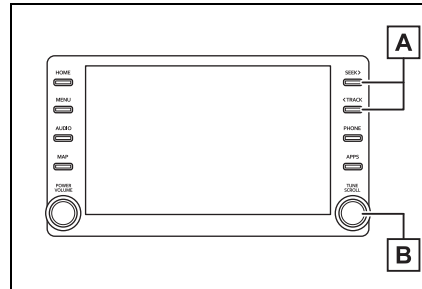

- A** Press to change the track. Press and hold to fast forward/rewind.
- B** Turn to change the track. Turn to move up/down the list. Also, the knob can be used to enter selections on the list screens by pressing it.

- Some functions may not be available depending on the type of model.
- When an iPod/iPhone is connected using a genuine iPod/iPhone cable, the iPod/iPhone starts charging its battery.
- Depending on the iPod/iPhone, the video sound may not be able to be heard.
- Depending on the iPod/iPhone and the songs in the iPod/iPhone, a cover art may be displayed. This function can be changed to "On" or "Off". (→P.444) It may take time to display the cover art, and the iPod/iPhone may not be operated while the cover art display is in process.
- When an iPod/iPhone is connected and the audio source is changed to iPod/iPhone mode, the iPod/iPhone will resume playing from the same point it was last

used.

- Depending on the iPod/iPhone that is connected to the system, certain functions may not be available.
- If an iPhone is connected via Bluetooth® and USB at the same time, system operation may become unstable. For known phone compatibility information, refer to <http://www.toyota.com/audio-multimedia>.
- Tracks selected by operating a connected iPod/iPhone may not be recognized or displayed properly.
- The system may not function properly if a conversion adapter is used to connect a device.

### Repeating

The track currently being listened to can be repeated.

- 1 Select .

- Each time  is selected, the mode changes as follows:
  - ▶ When shuffle is off (iPhone 5 or later)
    - track repeat → album repeat → off
  - ▶ When shuffle is off (iPhone 4s or earlier)
    - track repeat → off
  - ▶ When shuffle is on
    - track repeat → off

### Random order

Tracks or albums can be automatically and randomly selected.

- 1 Select .

- Each time  is selected, the mode changes as follows:
  - shuffle (1 album shuffle) → album shuffle (all album shuffle) → off

### WARNING

- Do not operate the player's controls or connect the iPod/iPhone while driving.

### NOTICE

- Do not leave your portable player in the car. In particular, high temperatures inside the vehicle may damage the portable player.
- Do not push down on or apply unnecessary pressure to the portable player while it is connected as this may damage the portable player or its terminal.
- Do not insert foreign objects into the port as this may damage the portable player or its terminal.

## Android Auto\*

\*: This function is not made available in some countries or areas.

### Overview

The Android Auto operation screen can be reached by the following methods: →P.421

- Connecting an Android Auto (→P.422)
- When an Apple CarPlay connection is established, this function will be unavailable.

### Control screen

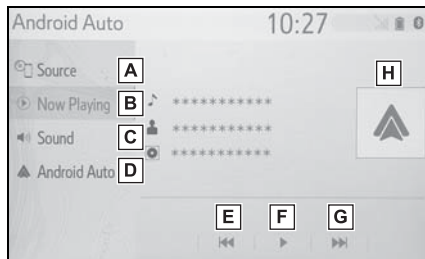

- A** Select to display the audio source selection screen.
- B** Select to return to the top screen.
- C** Select to display the sound setting screen. (→P.422)
- D** Select to display the audio control screen of Android Auto.
- E** Select to change the track.
- F** Select to play/pause.

- G** Select to change the track.
- H** Displays cover art

### Control panel

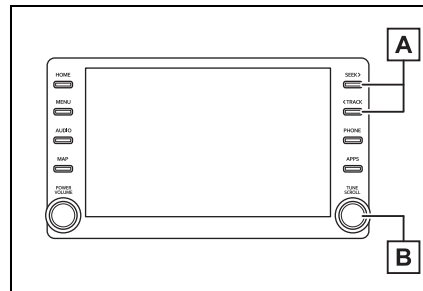

- A** Press to change the track.
- B** Turn to change the track.

#### ⚠ WARNING

- Do not connect smartphone or operate the controls while driving.

#### ⚠ NOTICE

- Do not leave your smartphone in the vehicle. In particular, high temperatures inside the vehicle may damage the smartphone.
- Do not push down on or apply unnecessary pressure to the smartphone while it is connected as this may damage the smartphone or its terminal.
- Do not insert foreign objects into the port as this may damage the smartphone or its terminal.

## Bluetooth® audio

The Bluetooth® audio system enables users to enjoy listening to music that is played on a portable player on the vehicle speakers via wireless communication.

This audio/visual system supports Bluetooth®, a wireless data system capable of playing portable audio music without cables. If your device does not support Bluetooth®, the Bluetooth® audio system will not function.

### Overview

The Bluetooth® audio operation screen can be reached by the following methods: →P.421

- Connecting a Bluetooth® audio device (→P.440)
- Depending on the type of portable player connected, some functions may not be available and/or the screen may look differently than shown in this manual.
- When an Apple CarPlay/Android Auto connection is established, Bluetooth® audio will be suspended and become unavailable.\*

\*: This function is not made available in some countries or areas.

### Control screen

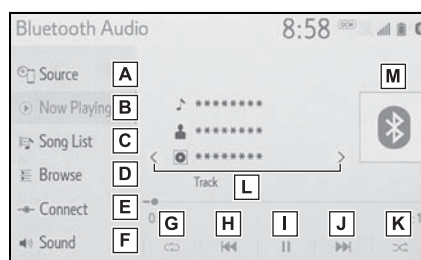

- A** Select to display the audio source selection screen.
- B** Select to return to the top screen.
- C** Select to display a song list screen.
- D** Select to display the play mode selection screen.
- E** Select to display the portable device connection screen. (→P.440)
- F** Select to display the sound setting screen. (→P.422)
- G** Select to set repeat playback. (→P.439)
- H** Select to change the track. Select and hold to fast rewind.
- I** Select to play/pause.
- J** Select to change the track. Select and hold to fast forward.
- K** Select to set random playback. (→P.439)

- L** Select to change the album.
- M** Displays cover art

**Control panel**

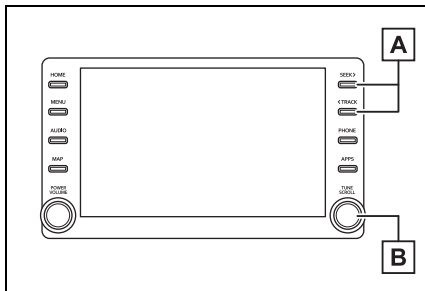

- A** Press to change the track. Press and hold to fast forward/rewind.
- B** Turn to change the track. Turn to move up/down the list. Also, the knob can be used to enter selections on the list screens by pressing it.

**Repeating**

The track or album currently being listened to can be repeated.

- 1 Select .

- Each time  is selected, the mode changes as follows:
  - ▶ When random playback is off
    - track repeat → album repeat → off
  - ▶ When random playback is on
    - track repeat → off



**Random order**

Tracks or albums can be automatically and randomly

selected.

- 1 Select .

- Each time  is selected, the mode changes as follows:
  - random (1 album random) → album random (all album random) → off

- Depending on the Bluetooth® device that is connected to the system, the music may start playing when selecting  while it is paused. Conversely, the music may pause when selecting  while it is playing.

- In the following conditions, the system may not function:
  - The Bluetooth® device is turned off.
  - The Bluetooth® device is not connected.
  - The Bluetooth® device has a low battery.

- When using the Bluetooth® audio and Wi-Fi® Hotspot functions at the same time, the following problems may occur:
  - It may take longer than normal to connect to the Bluetooth® device.
  - The sound may cut out.
- It may take time to connect the phone when Bluetooth® audio is being played.

- For operating the portable player, see the instruction manual that comes with it.

- If the Bluetooth® device is disconnected due to poor reception from the Bluetooth® network when the engine switch is in ACC or ON, the system automatically reconnects the portable player.

- If the Bluetooth® device is discon-

ected on purpose, such as it was turned off, this does not happen. Reconnect the portable player manually.

- Bluetooth® device information is registered when the Bluetooth® device is connected to the Bluetooth® audio system. When selling or disposing of the vehicle, remove the Bluetooth® audio information from the system. (→P.417)
- In some situations, sound output via the Bluetooth® audio system may be out of sync with the connected device or output intermittently.

#### WARNING

- Do not operate the player's controls or connect to the Bluetooth® audio system while driving.
- Your audio unit is fitted with Bluetooth® antennas. People with implantable cardiac pacemakers, cardiac resynchronization therapy-pacemakers or implantable cardioverter defibrillators should maintain a reasonable distance between themselves and the Bluetooth® antennas. The radio waves may affect the operation of such devices.

- Before using Bluetooth® devices, users of any electrical medical device other than implantable cardiac pacemakers, cardiac resynchronization therapy-pacemakers or implantable cardioverter defibrillators should consult the manufacturer of the device for information about its operation under the influence of radio waves. Radio waves could have unexpected effects on the operation of such medical devices.

#### NOTICE

- Do not leave your portable player in the vehicle. In particular, high temperatures inside the vehicle may damage the portable player.

### Registering/Connecting a Bluetooth® device

To use the Bluetooth® audio system, it is necessary to register a Bluetooth® device with the system.

- ▶ Registering an additional device
  - 1 Display the Bluetooth® audio control screen. (→P.438)
  - 2 Select "Connect".
  - 3 Select "Add Device".
- When another Bluetooth® device is connected, a confirmation screen will be displayed. To disconnect the Bluetooth® device, select "Yes".



- 4 Follow the steps in “Registering a Bluetooth® phone for the first time” from step 5. (→P.390)
- ▶ Selecting a registered device
- 1 Display the Bluetooth® audio control screen. (→P.438)
  - 2 Select “Connect”.
  - 3 Select the desired device to be connected.
  - 4 Check that a confirmation screen is displayed when the connection is complete.
- If an error message is displayed, follow the guidance on the screen to try again.

## Steering switches

### Steering switch operation

Some parts of the audio/visual system can be adjusted using the switches on the steering wheel.

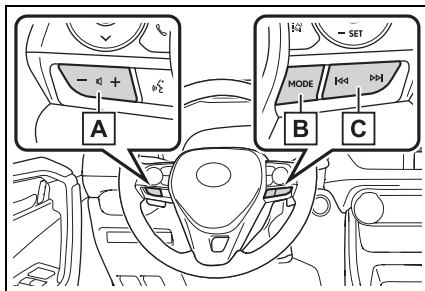

**A** Volume control switch

**B** “MODE” switch

**C** K<< >>K switch

#### ■ Volume control switch

- Press: Volume up/down
- Press and hold (0.8 sec. or more): Volume up/down continuously

#### ■ “MODE” switch

- ▶ AM/FM/SXM<sup>\*1</sup>
  - Press: Change audio modes
  - Press and hold (0.8 sec. or more): Mute/pause<sup>\*2</sup> (Press and hold again to resume)
- ▶ USB<sup>\*3, 4</sup>, iPod/iPhone<sup>\*4</sup>, Bluetooth<sup>®</sup> audio<sup>\*3, 4</sup>, Android Auto<sup>\*3</sup>, Toyota Apps<sup>\*3, 4</sup>
  - Press: Change audio modes
  - Press and hold (0.8 sec. or more): Pause (Press and hold

again to resume the play mode.)

<sup>\*1</sup>: This function is not made available in some countries or areas.

<sup>\*2</sup>: If cached radio is enabled, pressing and holding the “MODE” switch pauses the broadcast. (Press and hold again to play back the cached radio program.)

<sup>\*3</sup>: When an Apple CarPlay connection is established, this function will be unavailable.

<sup>\*4</sup>: When an Android Auto connection is established, this function will be unavailable.

#### ■ K<< >>K switch

##### ▶ AM/FM

- Press: Preset channel up/down
- Press and hold (0.8 sec. or more): Seek up/down
- Press and hold (1.5 sec. or more): Seek up/down continuously while the switch is being pressed
- Press and hold (1.5 sec. or more): Fast channel up/down

##### ▶ SXM<sup>\*1</sup>

- Press: Preset channel up/down
- Press and hold (0.8 sec. or more): Seek for stations in the relevant program type/channel category
- Press and hold (1.5 sec. or more): Fast channel up/down

- ▶ USB<sup>\*2, 3</sup>, iPod/iPhone<sup>\*3</sup>, Bluetooth® audio<sup>\*2, 3</sup>
  - Press: Track/file up/down
  - Press and hold (0.8 sec. or more): Fast forward/rewind

- ▶ Android Auto<sup>\*2</sup>
  - Press: Track up/down

<sup>\*1</sup>: This function is not made available in some countries or areas.

<sup>\*2</sup>: When an Apple CarPlay connection is established, this function will be unavailable.

<sup>\*3</sup>: When an Android Auto connection is established, this function will be unavailable.

### Setup

Detailed audio settings can be programmed.

### Displaying the audio settings screen

- 1 Press the "MENU" button.

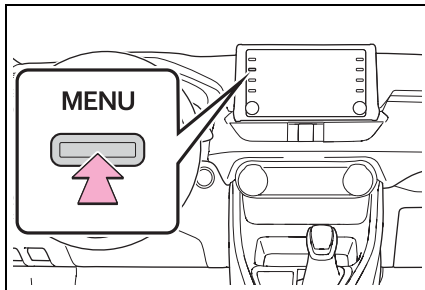

- 2 Select "Setup".
- 3 Select "Audio".
- 4 Select the desired items to be set.

### Audio settings screen



- A** Select to set the common settings. (→P.444)
- B** Select to set the radio settings. (→P.444)

### Common settings

- 1 Display the audio settings screen.  
→P.444
- 2 Select "Common".
- 3 Select the desired items to be set.

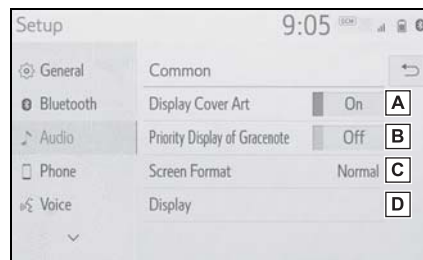

- A** Select to set the cover art display on/off.
- B** Select to prioritize the display of information from the Gracenote database.
- C** Select to change the screen size.\* (→P.423)
- D** Select to display the image quality adjustment screen.\* (→P.424)

\*: Only in USB video mode

### Radio settings

- 1 Display the audio settings screen  
→P.444
- 2 Select "Radio".
- 3 Select the desired number of preset radio stations displayed on the screen.

### **Manage smart favorites**

---

- 1 Select "Manage Smart Favorites".
- 2 Select the desired channel to be set.

- Displays the registered preset channels.
- Up to 20 channels can be registered.

### **Setting the number of radio presets**

---

- 1 Select "Number of Radio Presets".
- 2 Select the button with the desired number to be displayed.

### Operating information

- The use of a cellular phone inside or near the vehicle may cause a noise from the speakers of the audio/visual system which you are listening to. However, this does not indicate a malfunction.



#### NOTICE

- To avoid damage to the audio/visual system:
  - Be careful not to spill beverages over the audio/visual system.

### Radio

Usually, a problem with radio reception does not mean there is a problem with the radio — it is just the normal result of conditions outside the vehicle.

For example, nearby buildings and terrain can interfere with FM reception. Power lines or phone wires can interfere with AM signals. And of course, radio signals have a limited range. The farther the vehicle is from a station, the weaker its signal will be. In addition, reception conditions change constantly as the vehicle moves.

Here are some common reception problems that may not indicate a problem with the radio as described.

#### ■ FM

Fading and drifting stations: Generally, the effective range of

FM is about 25 miles (40 km). Once outside this range, you may notice fading and drifting, which increase with the distance from the radio transmitter. They are often accompanied by distortion.

Multi-path: FM signals are reflective, making it possible for 2 signals to reach the vehicle's antenna at the same time. If this happens, the signals will cancel each other out, causing a momentary flutter or loss of reception.

Static and fluttering: These occur when signals are blocked by buildings, trees or other large objects. Increasing the bass level may reduce static and fluttering.

Station swapping: If the FM signal being listened to is interrupted or weakened, and there is another strong station nearby on the FM band, the radio may tune in the second station until the original signal can be picked up again.

#### ■ AM

Fading: AM broadcasts are reflected by the upper atmosphere — especially at night. These reflected signals can interfere with those received directly from the radio station, causing the radio station to sound alternately strong and weak.

**Station interference:** When a reflected signal and a signal received directly from a radio station are very nearly the same frequency, they can interfere with each other, making it difficult to hear the broadcast.

**Static:** AM is easily affected by external sources of electrical noise, such as high tension power lines, lightening or electrical motors. This results in static.

■ **SiriusXM\***

- Cargo loaded on the roof luggage carrier, especially metal objects, may adversely affect the reception of SiriusXM Satellite Radio.
- Alternation or modifications carried out without appropriate authorization may invalidate the user's right to operate the equipment.

\*: This function is not made available in some countries or areas.

**iPod/iPhone**

■ **Certification**



- Use of the Made for Apple badge means that an accessory has been designed to connect specifically to the Apple product(s) identified in the badge, and has been certified by the developer to meet Apple performance standards. Apple is not responsible for the operation of this device or its compliance with safety and regulatory standards. Please note that the use of this accessory with an Apple product may affect wireless performance.
- iPhone, iPod, iPod classic, iPod nano, iPod touch, and Lightning are trademarks of Apple Inc., registered in the U.S. and other countries.

■ **Compatible models**

The following iPod touch® and iPhone® devices can be used with this system.

- Made for
- iPhone X
  - iPhone 8
  - iPhone 8 Plus
  - iPhone 7
  - iPhone 7 Plus
  - iPhone SE

- iPhone 6s
- iPhone 6s Plus
- iPhone 6
- iPhone 6 Plus
- iPhone 5s
- iPhone 5c
- iPhone 5
- iPod touch (6th generation)
- iPod touch (5th generation)

- This system only supports audio playback.
- Depending on difference between models or software versions etc., some models might be incompatible with this system.

### High-resolution sound source

This device supports high-resolution sound sources.

The definition of high-resolution is based on the standards of groups such as the CTA (Consumer Technology Association).

Supported formats and playable media are as follows.

#### ■ Supported formats

WAV, FLAC, ALAC, OGG Vorbis

#### ■ Playable media

USB

### File information

#### Compatible USB devices

USB communication formats	USB 2.0 HS (480 Mbps)
File formats	FAT 16/32
Correspondence class	Mass storage class

#### Compatible audio format

#### Compatible compressed files

Item	USB
Compatible file format	MP3/WMA/AAC
	WAV(LPCM)/FLAC/ALAC/OGG Vorbis
	MP4/AVI/WMV
Compatible file format (video)*	MP4/AVI/WMV
Folders in the device	Maximum 3000
Files in the device	Maximum 9999
Files per folder	Maximum 255

\*: USB video only



**Corresponding sampling frequency**

File type	Frequency (kHz)
MP3 files: MPEG 1 LAYER 3	32/44.1/48
MP3 files: MPEG 2 LSF LAYER 3	16/22.05/24
WMA files: Ver. 7, 8, 9* <sup>1</sup> (9.1/9.2)	32/44.1/48
AAC files: MPEG4/AAC-LC	11.025/12/16/ 22.05/24/32/ 44.1/48
WAV (LPCM) files* <sup>2</sup>	8/11.025/12/16/ 22.05/24/32/ 44.1/48/88.2/ 96/176.4/192
FLAC* <sup>2</sup>	8/11.025/12/16/ 22.05/24/32/ 44.1/48/88.2/ 96/176.4/192
ALAC* <sup>2</sup>	8/11.025/12/16/ 22.05/24/32/ 44.1/48/64/ 88.2/96
OGG Vorbis* <sup>2</sup>	8/11.025/16/ 22.05/32/44.1/ 48

\*<sup>1</sup>: Only compatible with Windows Media Audio Standard

\*<sup>2</sup>: Sound source of 48kHz or more is down-converted to 48kHz/24bit.

**Corresponding bit rates\*<sup>1</sup>**

File type	Bit rate (kbps)
MP3 files: MPEG 1 LAYER 3	32 - 320
MP3 files: MPEG 2 LSF LAYER 3	8 - 160
WMA files: Ver. 7, 8	CBR 48 - 192
WMA files: Ver. 9* <sup>2</sup> (9.1/9.2)	CBR 48 - 320
AAC files: MPEG4/AAC-LC	8 - 320
OGG Vorbis	32-500

\*<sup>1</sup>: Variable Bit Rate (VBR) compatible

\*<sup>2</sup>: Only compatible with Windows Media Audio Standard

File type	Quantization bit rate (bit)
WAV (LPCM) files	16/24
FLAC	
ALAC	

**Compatible channel modes**

File type	Channel mode
MP3 files	Stereo, joint stereo, dual channel and monaural
WMA files	2ch

File type	Channel mode
AAC files	1ch, 2ch (Dual channel is not supported)
WAV (LPCM)/ FLAC/ALAC/ OGG Vorbis	2ch

- MP3 (MPEG Audio Layer 3), WMA (Windows Media Audio) and AAC (Advanced Audio Coding) are audio compression standards.
- This system can play MP3/WMA/AAC files on USB memory.
- MP4, WMV and AVI files can use the following resolutions: 128x96, 160x120, 176x144 (QCIF), 320x240 (QVGA), 352x240 (SIF), 352x288 (CIF), 640x480 (VGA), 720x480 (NTSC), 720x576 (PAL)
- When naming an MP3/WMA/AAC file, add an appropriate file extension (.mp3/.wma/.m4a).
- This system plays back files with .mp3/.wma/.m4a file extensions as MP3/WMA/AAC files respectively. To prevent noise and playback errors, use the appropriate file extension.
- MP3 files are compatible with the ID3 Tag Ver. 1.0, Ver. 1.1, Ver. 2.2 and Ver. 2.3 formats. This system cannot display disc title, track title and artist name in other formats.
- WMA/AAC files can contain a WMA/AAC tag that is used in the same way as an ID3 tag. WMA/AAC tags carry information such as track title and artist name.
- The emphasis function is available only when playing MP3 files.
- This system can play back AAC files encoded by iTunes.
- The sound quality of MP3/WMA files generally improves with higher bit rates.
- m3u playlists are not compatible with the audio player.
- MP3i (MP3 interactive) and MP3PRO formats are not compatible with the audio player.
- The player is compatible with VBR (Variable Bit Rate).
- When playing back files recorded as VBR (Variable Bit Rate) files, the play time will not be correctly displayed if the fast forward or reverse operations are used.
- It is not possible to check folders that do not include MP3/WMA/AAC files.
- MP3/WMA/AAC files in folders up to 8 levels deep can be played. However, the start of playback may be delayed

when using USB memory containing numerous levels of folders. For this reason, we recommend creating USB memory with no more than 2 levels of folders.

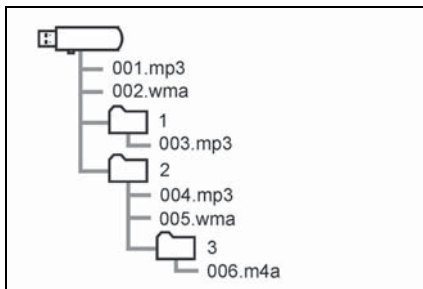

- The play order of the USB memory with the structure shown above is as follows:

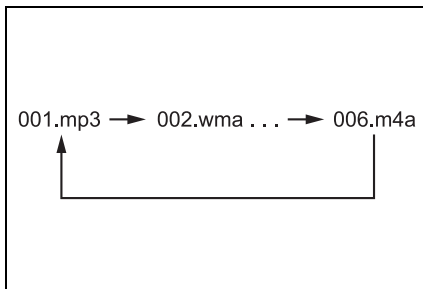

- The order changes depending on the personal computer and MP3/WMA/AAC encoding software you use.

### Compatible video format

Format	Codec
MPEG-4	Video codec: • H.264/MPEG-4 AVC • MPEG4  Audio codec: • AAC • MP3  Corresponding screen size: • MAX 1920 × 1080  Corresponding frame rate: • MAX 60i/30p

Format	Codec
AVI Container	<p>Video codec:</p> <ul style="list-style-type: none"> <li>• H.264/MPEG-4 AVC</li> <li>• MPEG4</li> <li>• WMV9</li> <li>• WMV9 Advanced profile</li> </ul> <p>Audio codec:</p> <ul style="list-style-type: none"> <li>• AAC</li> <li>• MP3</li> <li>• WMA9.2 (7, 8, 9.1, 9.2)</li> </ul> <p>Corresponding screen size:</p> <ul style="list-style-type: none"> <li>• MAX 1920 × 1080</li> </ul> <p>Corresponding frame rate:</p> <ul style="list-style-type: none"> <li>• MAX 60i/30p</li> </ul>
Windows Media Video	<p>Video codec:</p> <ul style="list-style-type: none"> <li>• WMV9</li> <li>• WMV9 Advanced profile</li> </ul> <p>Audio codec:</p> <ul style="list-style-type: none"> <li>• WMA9.2 (7, 8, 9.1, 9.2)</li> </ul> <p>Corresponding screen size:</p> <ul style="list-style-type: none"> <li>• MAX 1920 × 1080</li> </ul> <p>Corresponding frame rate:</p> <ul style="list-style-type: none"> <li>• MAX 60i/30p</li> </ul>

### Terms

#### ■ ID3 tag

- This is a method of embed-

ding track-related information in an MP3 file. This embedded information can include the track number, track title, the artist's name, the album title, the music genre, the year of production, comments, cover art and other data. The contents can be freely edited using software with ID3 tag editing functions. Although the tags are restricted to a number of characters, the information can be viewed when the track is played back.

#### ■ WMA tag

- WMA files can contain a WMA tag that is used in the same way as an ID3 tag. WMA tags carry information such as track title and artist name.

#### ■ MP3

- MP3 is an audio compression standard determined by a working group (MPEG) of the ISO (International Standard Organization). MP3 compresses audio data to about 1/10 the size of that on conventional discs.

#### ■ WMA

- WMA (Windows Media Audio) is an audio compression format developed by Microsoft®. It compresses files into a size smaller than that of MP3 files. The decoding formats for

WMA files are Ver. 7, 8 and 9.

- Windows Media is either a registered trademark or trademark of Microsoft Corporation in the United States and/or other countries. This product includes technology owned by Microsoft Corporation and cannot be used or distributed without a license from Microsoft Licensing, Inc.

■ **AAC**

- AAC is short for Advanced Audio Coding and refers to an audio compression technology standard used with MPEG2 and MPEG4.

**Error messages**

■ **USB**

Message	Explanation
“USB Error”	This indicates a problem in the USB memory or its connection.
“No music files found.”	This indicates that no MP3/WMA/AAC files are included in the USB memory.
“No video files found.”	This indicates that no video files are included in the USB memory.

■ **iPod**

Message	Explanation
“iPod Error”	This indicates a problem in the iPod or its connection.
“No music files found.”	This indicates that there is no music data in the iPod.
“Please check the iPod firmware version.”	This indicates that the software version is not compatible. Perform the iPod firmware updates and try again.
“Unable to authorize the iPod.”	This indicates that it failed to authorize the iPod. Please check your iPod.

■ **Bluetooth® audio**

Message	Explanation
“Music tracks not supported. Please check your portable player.”	This indicates a problem in the Bluetooth® device.

- If the malfunction is not rectified: Take your vehicle to your Toyota dealer.

### Certification

- ▶ For vehicles sold in the U.S.A., Hawaii, Guam, Saipan, American Samoa and Puerto Rico

FCC ID: AJDK101, AJDK102

[For 2.4 GHz Radio Transmitters]

This equipment complies with FCC/ISED radiation exposure limits set forth for an uncontrolled environment and meets the FCC radio frequency (RF) Exposure Guidelines and RSS-102 of the IC radio frequency (RF) Exposure rules. This equipment should be installed and operated keeping the radiator at least 20 cm or more away from person's body.

This transmitter must not be co-located or operated in conjunction with any other antenna or transmitter.

This device complies with Part 15 of FCC Rules and Innovation, Science, and Economic Development Canada licence-exempt RSS standard(s). Operation is subject to the following two conditions: (1) this device may not cause interference, and (2) this device must accept any interference, including interference that may cause undesired operation of this device.

Information to User - Alteration or modifications carried out without appropriate authorization may invalidate the user's right to operate the equipment.

► For vehicles sold in Canada

IC: 775E-K101, 775E-K102

[For 2.4 GHz Radio Transmitters]

This equipment complies with FCC/ISED radiation exposure limits set forth for an uncontrolled environment and meets the FCC radio frequency (RF) Exposure Guidelines and RSS-102 of the ISED radio frequency (RF) Exposure rules. This equipment should be installed and operated keeping the radiator at least 20 cm or more away from person's body.

[Pour 2,4 GHz émetteurs radio]

Cet équipement est conforme aux limites d'exposition aux rayonnements énoncées pour un environnement non contrôlé et respecte les règles les radioélectriques (RF) de la FCC lignes directrices d'exposition et d'exposition aux fréquences radioélectriques (RF) CNR-102 de l'ISDE. Cet équipement doit être installé et utilisé en gardant une distance de 20 cm ou plus entre le radiateur et le corps humain.

This device complies with Part 15 of FCC Rules and Innovation, Science, and Economic Development Canada licence-exempt RSSs. Operation is subject to the following two conditions: (1) This device may not cause interference; and (2) This device must accept any interference, including interference that may cause undesired operation of the device.

Le présent appareil est conforme aux la partie 15 des règles de la FCC et CNR d'Innovation, Sciences et Développement économique Canada applicables aux appareils radio exempts de licence. L'exploitation est autorisée aux deux conditions suivantes: (1) l'appareil ne doit pas produire de brouillage; (2) l'utilisateur de l'appareil doit accepter tout brouillage radioélectrique subi, même si le brouillage est susceptible d'en compromettre le fonctionnement.

**► Gracenote**

Gracenote, the Gracenote logo and logotype, “Powered by Gracenote” and Gracenote MusicID are either registered trademarks or trademarks of Gracenote, Inc. in the United States and/or other countries.

**Gracenote® End User License Agreement**

This application or device contains software from Gracenote, Inc. of Emeryville, California (“Gracenote”). The software from Gracenote (the “Gracenote Software”) enables this application to perform disc and/or file identification and obtain music-related information, including name, artist, track, and title information (“Gracenote Data”) from online servers or embedded databases (collectively, “Gracenote Servers”) and to perform other functions. You may use Gracenote Data only by means of the intended End-User functions of this application or device.

You agree that you will use Gracenote Data, the Gracenote Software, and Gracenote Servers for your own personal non-commercial use only. You agree not to assign, copy, transfer or transmit the Gracenote Software or any Gracenote Data to any third party. **YOU AGREE NOT TO USE OR EXPLOIT GRACENOTE DATA, THE GRACENOTE SOFTWARE, OR GRACENOTE SERVERS, EXCEPT AS EXPRESSLY PERMITTED HEREIN.**

You agree that your non-exclusive license to use the Gracenote Data, the Gracenote Software, and Gracenote Servers will terminate if you violate these restrictions. If your license terminates, you agree to cease any and all use of the Gracenote Data, the Gracenote Software, and Gracenote Servers. Gracenote reserves all rights in Gracenote Data, the Gracenote Software, and the Gracenote Servers, including all ownership rights. Under no circumstances will Gracenote become liable for any payment to you for any information that you provide. You agree that Gracenote, Inc. may enforce its rights under this Agreement against you directly in its own name.

The Gracenote service uses a unique identifier to track queries for statistical purposes. The purpose of a randomly assigned numeric identifier is to allow the Gracenote service to count queries without knowing anything about who you are. For more information, see the web page for the Gracenote Privacy Policy for the Gracenote service.

The Gracenote Software and each item of Gracenote Data are licensed to you “AS IS.” Gracenote makes no representations or warranties, express or implied, regarding the accuracy of any Gracenote Data from in the Gracenote Servers. Gracenote reserves the right to delete data from the Gracenote Servers or to change data categories for any cause that Gracenote deems sufficient. No warranty is made that the Gracenote Software or Gracenote Servers are error-free or that functioning of Gracenote Software or Gracenote Servers will be uninterrupted. Gracenote is not obligated to provide you with new enhanced or additional data types or categories that Gracenote may provide in the future and is free to discontinue its services at any time.

**GRACENOTE DISCLAIMS ALL WARRANTIES EXPRESS OR IMPLIED, INCLUDING, BUT NOT LIMITED TO, IMPLIED WARRANTIES OF MERCHANTABILITY, FITNESS FOR A PARTICULAR PURPOSE, TITLE, AND NON-INFRINGEMENT. GRACENOTE DOES NOT WARRANT THE RESULTS THAT WILL BE OBTAINED BY YOUR USE OF THE GRACENOTE SOFTWARE OR ANY GRACENOTE SERVER. IN NO CASE WILL GRACENOTE BE LIABLE FOR ANY CONSEQUENTIAL OR INCIDENTAL DAMAGES OR FOR ANY LOST PROFITS OR LOST REVENUES.**

copyright © 2000 to present Gracenote



► For U.S. owners

Total Traffic and Weather Network, a division of TTWN Media Networks, LLC (“TTWN”), owns or holds the rights to the traffic, news, sports, weather, stocks and other data (the “TTWN Data”) and network through which it is delivered, together the “TTN Service”. Use of the TTN Service is subject to the terms of these Device End User Terms.

THE TTWN SERVICE IS INFORMATIONAL ONLY. YOUR USE OF TTWN SERVICE IS AT YOUR SOLE RISK. TTWN DATA IS PROVIDED “AS IS”, “WHERE IS”, AND “WHERE AVAILABLE”. TTWN AND ITS SUPPLIERS AND LICENSORS EXPRESSLY DISCLAIM ALL WARRANTIES WITH RESPECT TO THE TTWN SERVICE (INCLUDING, WITHOUT LIMITATION, THAT THE TTWN DATA WILL BE ERROR-FREE, THAT THE TTWN SERVICE WILL OPERATE WITHOUT INTERRUPTION OR THAT THE TTWN DATA WILL BE ACCURATE), EXPRESS, IMPLIED OR STATUTORY, INCLUDING, WITHOUT LIMITATION, THE IMPLIED WARRANTIES OF MERCHANTABILITY, NON-INFRINGEMENT, FITNESS FOR A PARTICULAR PURPOSE, OR THOSE ARISING FROM A COURSE OF DEALING OR USAGE OF TRADE.

TTWN AND ITS SUPPLIERS AND LICENSORS WILL NOT BE LIABLE TO YOU UNDER ANY LEGAL THEORY, INCLUDING CONTRACT, TORT, NEGLIGENCE OR STRICT LIABILITY, FOR ANY DIRECT, INDIRECT, INCIDENTAL, SPECIAL, PUNITIVE, CONSEQUENTIAL OR EXEMPLARY DAMAGES, INCLUDING BUT NOT LIMITED TO, DAMAGES FOR LOSS OF PROFITS, GOODWILL, USE, DATA OR OTHER INTANGIBLE LOSSES (EVEN IF TTWN, ITS SUPPLIERS OR LICENSORS HAS BEEN ADVISED OF THE POSSIBILITY OF SUCH DAMAGES), RESULTING FROM OR ARISING OUT OF YOUR USE OF, OR YOUR INABILITY TO USE, THE TTWN SERVICE, THIS AGREEMENT, OR ANY OTHER MATTER RELATING TO THE TTWN SERVICE.

SOME JURISDICTIONS DO NOT ALLOW THE EXCLUSION OF CERTAIN WARRANTIES OR THE LIMITATION OR EXCLUSION OF LIABILITY FOR INCIDENTAL OR CONSEQUENTIAL DAMAGES. ACCORDINGLY, SOME OF THE ABOVE LIMITATIONS MAY NOT APPLY TO YOU.

## Voice command system

The voice command system enables the radio, phone dialing, etc. to be operated using voice commands. Refer to the command list for samples of voice commands. (→P.461)

## Using the voice command system

### Steering switch

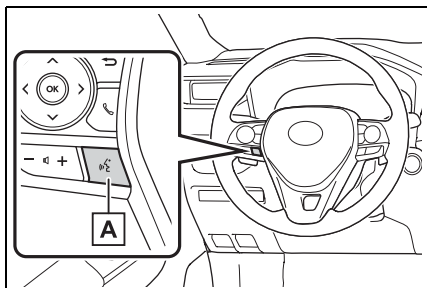

#### A Talk switch

- ▶ Voice command system
  - Press the talk switch to start the voice command system. To cancel voice command, press and hold the talk switch.
- ▶ When an Apple CarPlay/Android Auto connection is established
  - Press and hold the talk switch to start Siri/Google Assistant. To cancel Siri/Google Assistant, press the talk switch.
  - Press the talk switch to start

the voice command system.

### Microphone

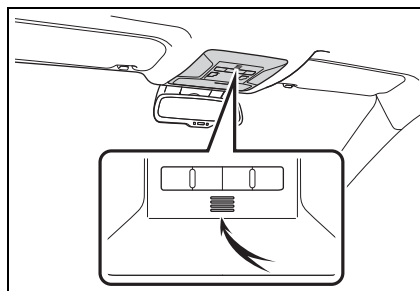

- It is unnecessary to speak directly into the microphone when giving a command.
- 
- Voice commands may not be recognized if:
    - Spoken too quickly.
    - Spoken at a low or high volume.
    - The roof or windows are open.
    - Passengers are talking while voice commands are spoken.
    - The fan speed of the air conditioning system is set at high.
    - The air conditioning vents are turned towards the microphone.
  - In the following conditions, the system may not recognize the command properly and using voice commands may not be possible:
    - The command is incorrect or unclear. Note that certain words, accents or speech patterns may be difficult for the system to recognize.
    - There is excessive background noise, such as wind noise.
  - Normally, it is necessary to wait for a beep before saying a command. To enable the ability to talk over prompts and say commands before the beep, enable the voice prompt interrupt function. (→P.418)
  - This system may not operate immediately after the engine

switch is in ACC or ON.

 **NOTICE**

- Do not touch and put a sharp object to the microphone. It may cause failure.

**Voice command system operation**

The voice command system is operated by saying commands which correspond to a supported function. To display examples of commands for supported functions, select a function button on the screen after starting the voice command system.

**Operation from the main menu**

1 Press the talk switch.

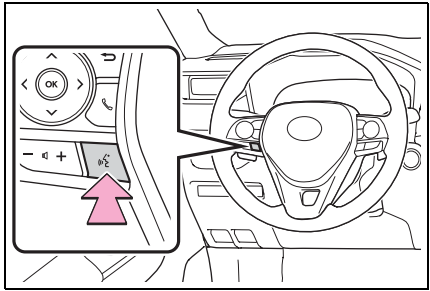



- Voice guidance for the voice command system can be skipped by pressing the talk switch.
- 2 If "Getting Started with Voice" screen is displayed, select "OK" or press the talk switch. (→P.460)

3 After hearing a beep, say a supported command.

- To display sample commands of the desired function, say the desired function or select the desired function button. To display more commands, select "More Commands".
- Selecting "Help" or saying "Help" prompts the voice command system to offer examples of commands and operation methods.
- Registered POIs, registered names in the contacts list etc., can be said in the place of the "<>" next to the commands. (→P.461)

For example: Say "Find a restaurant", "Call John Smith" etc.

- If a desired outcome is not shown, or if no selections are available, perform one of the following to return to the previous screen:
  - Say "Go back".
  - Select .
  - To cancel voice recognition, select , say "Cancel", or press and hold the talk switch.
  - To perform the voice command operation again, select "Start Over" or say "Start over".
  - To suspend voice command operation, select "Pause" or say "Pause". To resume the

voice command operation, select “Resume” or press the talk switch.

- If the system does not respond or the confirmation screen does not disappear, press the talk switch and try again.
- If a voice command cannot be recognized 3 consecutive times, voice recognition will be canceled.
- Voice recognition prompts can be changed on the voice settings screen. (→P.418)

This function can be used to cancel voice guidance by turning the voice prompts off. When you press the talk switch while using this setting, a beep sounds, and then you can immediately say a command.

- Some voice guidance can be canceled by setting voice prompts to off. Use this setting when it is desirable to say a command immediately after pressing the talk switch and hearing a beep.

### Increasing the voice recognition performance

To increase voice recognition performance, use the “Tutorials” and “Voice Training” functions on the “Getting Started with Voice” screen. These functions are only available when the vehicle is not moving.

The “Tutorials” and “Voice Training” functions can also be started on the voice settings screen. (→P.418)

- 1 Press the talk switch.

- 2 Select the desired item to be set.

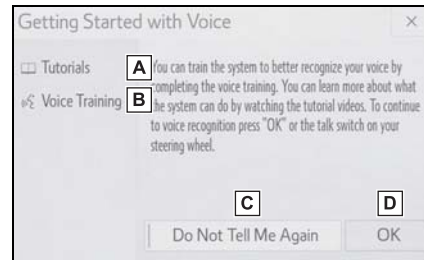

- A** Select to display the voice command tutorials.
- B** Select to train the voice command system.

The user will be asked to say 10 sample phrases. This will help the voice command system adapt to the user’s accent.

- C** Select to prevent the screen from being displayed again.
- D** Select to proceed to the voice command screen.

Command list

Command list overview

Recognizable voice commands and their actions are shown below.

- Frequently used commands are listed in the following tables.
- For devices that are not installed to the vehicle, commands relating to that device may not be displayed on the screen. Also, depending on other conditions, such as compatibility, some commands may not be displayed on the screen.
- The functions available may vary according to the system installed.
- Voice recognition language can be changed. (→P.414)
- When an Apple Car-Play/Android Auto connection is established, some commands will become unavailable.

Command list

■ Common

Command	Action
“Help”	Displays examples of some of the available commands
“Go back”	Returns to the previous screen
“Cancel”	Cancels the voice command system
“Start over”	Returns to top menu screen
“Pause”	Temporarily pauses a voice session until it is resumed by pressing the talk switch again.

■ Top menu

Command	Action
“Show command examples for <menu>”	Displays the command list of the selected menu
“More commands”	Displays more commonly used commands
“Voice settings”	Displays Voice Setting screen
“Train my voice”	Displays Train Voice Recognition screen *

\*: Vehicle must be parked

### ■ Phone

Command	Action
“Call <contact>”*	Places a call to the specified contact from the phone book
“Call <contact> <phone type>”*	Places a call to the specified phone type of the contact from the phone book
“Dial <phone number>”	Places a call to the specified phone number
“Redial”	Places a call to the phone number of the latest outgoing call
“Call back”	Places a call to the phone number of latest incoming call
“Show recent calls”	Displays the call history screen
“Send a message to <contact>”	Sends a text message to specified contact from the phone book

\*: If the system does not recognize the name of a contact, create a voice tag. (→P.483) The name of a contact can also be recognized by adding a voice tag.

### ■ While in a phone call

Command	Action
“Send <digits>”	Sends DTMF tones has specified
“Mute”	Mutes the microphone (far side cannot hear the conversation)
“Unmute”	Unmutes the microphone

### ■ While incoming message notification is displayed\*

Command	Action
“Read message”	Reads the incoming message over the vehicle speakers
“Ignore”	Ignores the incoming message notification
“Reply”	Initiates sending a reply to the incoming message
“Call”	Places a call to the phone number of incoming message

\*: Full screen message notification must be turned on within the phone settings (→P.481)

■ Radio

Command	Action
“Tune to <frequency> AM”	Changes the radio to the specified AM frequency
“Tune to <frequency> FM”	Changes the radio to the specified FM frequency
“Play a <genre> station”	Changes the radio to an FM station of the specified genre *1
“Tune to preset <1-36>”	Changes the radio to the specified preset radio station
“Tune to a <genre> satellite station”	Changes the radio to a satellite radio channel of the specified genre *2
“Tune to <satellite channel name>”	Changes the radio to the satellite radio channel with the specified name *2
“Tune to channel <number> on XM”	Changes the radio to a satellite radio channel of the specified number *2

\*1: A station list must be built first using the radio screen (→P.425)

\*2: Requires a satellite radio subscription

■ Audio \*

Command	Action
“Play Playlist <name>”	Plays tracks from the selected playlist
“Play Artist <name>”	Plays tracks from the selected artist
“Play Song <name>”	Plays the selected track
“Play Album <name>”	Plays tracks from the selected album
“Play Genre <name>”	Plays tracks from the selected genre
“Play Composer <name>”	Plays tracks from the selected composer
“Play Podcast <name>”	Plays tracks from the selected podcast
“Play Audiobook <name>”	Plays tracks from the selected audiobook
“Audio On”	Turns the audio/visual system on
“Audio Off”	Turns the audio/visual system off
“Change the audio source to <source name>”	Sets the source to the specified audio mode

\*: The audio device must be connected via a USB cable to use the

functionality in this section

### ■ Toyota Apps

Command	Action
“Launch <application name>”*	Activates the Toyota Apps

\*: When an application is opened and is in full screen mode, pressing the talk switch will start the voice command system and commands for the currently displayed application will be available

- 
- Commands relating to operation of the audio/visual system can only be performed when the audio/visual system is turned on.



Quick reference

**Phone screen operation**

The phone screen can be reached by the following methods:

- ▶ From the “PHONE” button
  - 1 Press the “PHONE” button.
- ▶ From the “MENU” button
  - 1 Press the “MENU” button, then select “Phone”.



**Bluetooth® hands-free system operation**

The following functions can be used on phone operation:

- Registering/connecting a Bluetooth® device (→P.390)
- Placing a call using the Bluetooth® hands-free system (→P.470)
- Receiving a call using the Bluetooth® hands-free system (→P.473)
- Talking on the Bluetooth® hands-free system (→P.474)

**Message function**

The following function can be used on message function:

- Using the Bluetooth® phone message function (→P.476)

**Setting up a phone**

The following functions can be made in the system:

- Phone settings (→P.481)
- Bluetooth® settings (→P.394)

### Some basics

**The hands-free system enables calls to be made and received without having to take your hands off the steering wheel.**

**This system supports Bluetooth®. Bluetooth® is a wireless data system that enables cellular phones to be used without being connected by a cable or placed in a cradle.**

**The operating procedure of the phone is explained here.**

**When an Apple CarPlay connection is established, phone functions will be performed by Apple CarPlay instead of the hands-free system.**

- When using the hands-free system or Bluetooth® audio and Wi-Fi® Hotspot functions at the same time, the following problems may occur:
    - The Bluetooth® connection may be cut.
    - Noise may be heard on the Bluetooth® audio playback.
    - A noise may be heard during phone calls.
  - Bluetooth® uses the 2.4 GHz frequency band. If both a Wi-Fi® connection and Bluetooth® connection are being used simultaneously, each connection may be affected.
  - If a Bluetooth® device is attempting to connect to the vehicle while another device is connected as a Bluetooth® audio device or connected using the hands-free system or Wi-Fi® Hotspot function, the communication speed may decrease or malfunctions may occur, such as image distortion or audio skipping. If a Bluetooth® device is connected to the system, the interference it may cause will be reduced. When carrying a device with its Bluetooth® connection enabled, make sure to register it to the system and connect it or disable its Bluetooth® function.
  - When a device is connected via Bluetooth®, the Bluetooth® icon on the status bar will be displayed in blue. (→P.378)
- This system is not guaranteed to operate with all Bluetooth® devices.
  - If your cellular phone does not support Bluetooth®, this system cannot function.
  - In the following conditions, the system may not function:
    - The cellular phone is turned off.
    - The current position is outside the communication area.
    - The cellular phone is not connected.
    - The cellular phone has a low battery.
  - Depending on the type of Bluetooth® phone, some function is not available.

#### WARNING

- While driving, do not operate a cellular phone.

**⚠ WARNING**

- Your audio unit is fitted with Bluetooth® antennas. People with implantable cardiac pacemakers, cardiac resynchronization therapy-pacemakers or implantable cardioverter defibrillators should maintain a reasonable distance between themselves and the Bluetooth® antennas. The radio waves may affect the operation of such devices.
- Before using Bluetooth® devices, users of any electrical medical device other than implantable cardiac pacemakers, cardiac resynchronization therapy-pacemakers or implantable cardioverter defibrillators should consult the manufacturer of the device for information about its operation under the influence of radio waves. Radio waves could have unexpected effects on the operation of such medical devices.

**⚠ NOTICE**

- Do not leave your cellular phone in the vehicle. The temperature inside may rise to a level that could damage the phone.

**Registering/Connecting a Bluetooth® phone**

To use the hands-free system for cellular phones, it is necessary to register a cellular phone with the system. (→P.390)

**■ Connecting a Bluetooth® device**

- ▶ Registering an additional device
  - 1 Display the phone top screen. (→P.465)
  - 2 Select “Select Device”.
  - 3 Select “Add Device”.
- When another Bluetooth® device is connected, a confirmation screen will be displayed. To disconnect the Bluetooth® device, select “Yes”.
- 4 Follow the steps in “Registering a Bluetooth® phone for the first time” from step 5. (→P.390)
- ▶ Selecting a registered device
  - 1 Display the phone top screen. (→P.465)
  - 2 Select “Select Device”.
  - 3 Select the desired device to be connected.
  - 4 Check that a confirmation screen is displayed when the connection is complete.
- If an error message is displayed, follow the guidance on the screen to try again.
- **Bluetooth® phone condition display**

The condition of the Bluetooth® phone appears on the upper right side of the screen.

(→P.378)

### Using the phone switch/microphone

#### ■ Steering switch

By pressing the phone switch, a call can be received or ended without taking your hands off the steering wheel.

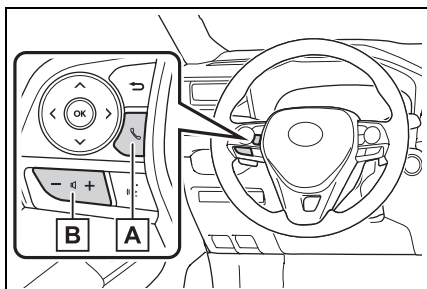

#### A Phone switch

- If the switch is pressed during a call, the call will end.
- If the switch is pressed when an incoming call is received, the call will be answered.
- If the switch is pressed during a call when a separate incoming call is waiting, the waiting call will be answered.
- If the switch is pressed when an Apple CarPlay/Android Auto connection is established, the Apple CarPlay/Android Auto phone application will be displayed on the system screen.

#### B Volume control switch

- Press the "+" side to increase the volume.
- Press the "-" side to decrease the volume.

#### ■ Microphone

The microphone is used when talking on the phone.

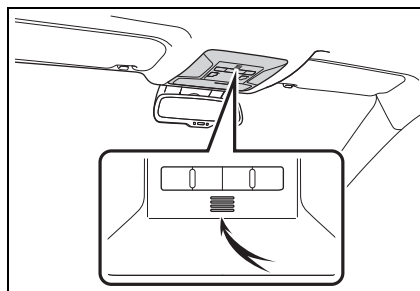

- The other party's voice will be heard from the front speakers. The audio/visual system will be muted during phone calls or when hands-free voice commands are used.
- Talk alternately with the other party on the phone. If both parties speak at the same time, the other party may not hear what has been said. (This is not a malfunction.)
- Keep call volume down. Otherwise, the other party's voice may be audible outside the vehicle and voice echo may increase. When talking on the phone, speak clearly towards the microphone.
- The other party may not hear you clearly when:
  - Driving on an unpaved road. (Making excessive traffic noise.)
  - Driving at high speeds.
  - The roof or windows are open.
  - The air conditioning vents are pointed towards the microphone.
  - The sound of the air conditioning fan is loud.
- There is a negative effect on sound quality due to the phone and/or network being used.

**NOTICE**

- Do not touch and put a sharp object to the microphone. It may cause failure.

**Voice command system**

Press the talk switch to operate the voice command system.

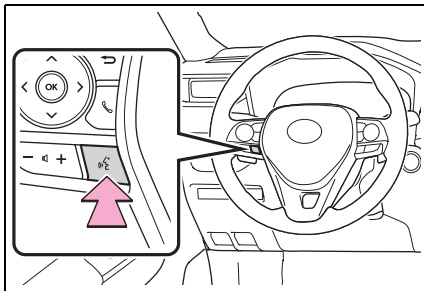

- The voice command system and its list of commands can be operated. (→P.458)

**About the contacts in the contact list**

- The following data is stored for every registered phone. When another phone is connected, the following registered data cannot be read:
  - Contact data
  - Call history data
  - Favorites data
  - Image data
  - All phone settings
  - Message settings
- When a phone's registration is deleted, the above-mentioned data is also deleted.

**When selling or disposing of the vehicle**

A lot of personal data is registered when the hands-free system is used. When selling or disposing of the vehicle, initialize the data. (→P.417)

- The following data in the system can be initialized:
  - Contact data
  - Call history data
  - Favorites data
  - Image data
  - All phone settings
  - Message settings
- Once initialized, the data and settings will be erased. Pay additional attention when initializing the data.

**Placing a call using the Bluetooth® hands-free system**

After a Bluetooth® phone has been registered, a call can be made using the hands-free system. There are several methods by which a call can be made, as described below.

**Calling methods on the Bluetooth® phone**

- 1 Display the phone top screen. (→P.465)
- 2 Select the desired method to call from.



**Calling methods from phone screen**

- By call history (→P.470)
- By favorites (→P.471)
- By contacts (→P.471)
- By keypad (→P.472)
- By message (→P.479)

**Also the following lists are available from each function's screen**

- By voice command system (→P.459)
- By home screen (→P.473)

**By call history**

Up to 30 of the latest call history items (missed, incoming and outgoing) can be selected.

- 1 Display the phone top screen. (→P.465)
  - 2 Select "History" and select the desired contact.
- If the contact which is not registered on the contact list is selected, the name is displayed as "Unknown Contact". In this case, select the number to make a call properly.
- 3 Check that the dialing screen is displayed.

● The icons of call type are displayed.

: Missed call

: Incoming call

: Outgoing call

- When making a call to the same number continuously, only the most recent call is listed in call history.
- When a phone number registered in the contact list is received, the name is displayed.
- Number-withheld calls are also

memorized in the system.

- International phone calls may not be made depending on the type of Bluetooth® phone you have.
- The list should group together consecutive entries with the same phone number and same call type. For example, two calls from John's mobile would be displayed as follows: John (2)

### By favorites list

Calls can be made using registered contacts which can be selected from a contact list.

(→P.471)

- 1 Display the phone top screen. (→P.465)
- 2 Select "Favorites" and select the desired contact.
- 3 Select the desired number.
- 4 Check that the dialing screen is displayed.

### By contacts list

Calls can be made by using contact data which is transferred from a registered cellular phone. (→P.483)

Up to 5000 contacts (maximum of 4 phone numbers, e-mail addresses and addresses per contact) can be registered in the contact list.

- 1 Display the phone top screen. (→P.465)
- 2 Select "Contacts" and select the desired contact.

- 3 Select the desired number.

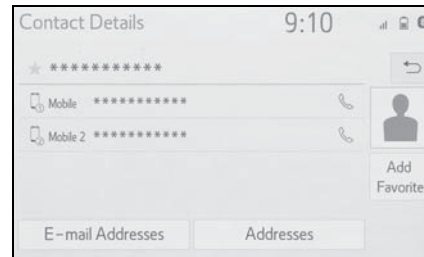

"Add Favorite"/"Remove Favorite": Select to register/remove the contact in the favorites list. (→P.488)

"E-mail Addresses": Select to display all registered e-mail addresses for the contact.

"Addresses": Select to display all registered addresses for the contact.

- 4 Check that the dialing screen is displayed.

### When the contact list is empty

- For PBAP compatible Bluetooth® phones when "Automatic Transfer" is set to on (→P.483)
- Contacts are transferred automatically.

■ **For PBAP compatible Bluetooth® phones when “Automatic Transfer” is set to off (→P.483)**

1 Select the desired item.

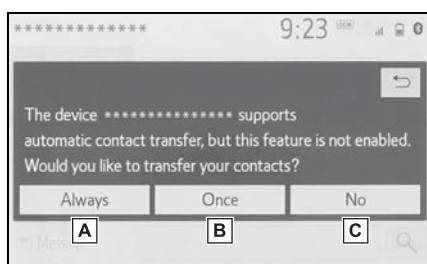

- A** Select to always transfer all the contacts from a connected cellular phone automatically.
- B** Select to transfer all the contacts from a connected cellular phone only once.
- C** Select to cancel transferring.

2 Check that a confirmation screen is displayed when the operation is complete.

■ **For PBAP incompatible but OPP compatible Bluetooth® phones**

1 Select the desired item.

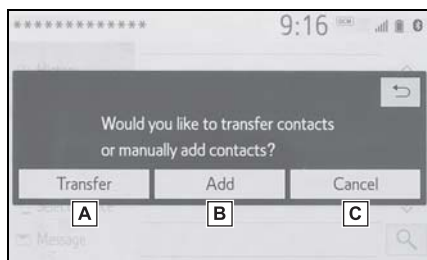

- A** Select to transfer the con-

tacts from the connected cellular phone.



Transfer the contact data to the system using a Bluetooth® phone.

- B** Select to add a new contact manually. Follow the steps in “Registering a new contact to the contacts list” from step 2. (→P.486)

- C** Select to cancel transferring.

- If your cellular phone is neither PBAP nor OPP compatible, the contacts cannot be transferred using Bluetooth®. But the contacts can be transferred from USB device. (→P.486)
- Depending on the type of Bluetooth® phone:
  - It may be necessary to perform additional steps on the phone when transferring contact data.
  - The registered image in the contact list may not transfer depending on the type of Bluetooth® phone connected.

**By keypad**

- 1 Display the phone top screen. (→P.465)
- 2 Select “Keypad” and enter the phone number.
- 3 Select  or press the  switch on the steering wheel.
- 4 Check that the dialing screen is displayed.

- Depending on the type of Blue-



tooth® phone being connected, it may be necessary to perform additional steps on the phone.

**By home screen**

- 1 Display the home screen. (→P.384)
- 2 Select the desired contact.
- 3 Check that the dialing screen is displayed.

■ **Registering a new contact**

- 1 Select and hold the screen button to add a contact.
  - 2 Select the desired contact.
  - 3 Select the desired number.
- If there is no contact in the contacts list, the contacts cannot be registered at the home screen.
  - The contact cannot be registered at the home screen while driving.

Receiving a call using the Bluetooth® hands-free system

When a call is received, the following screen is displayed with a sound.

**Incoming calls**

- 1 Select “Answer” or press the  switch on the steering wheel to talk on the phone.

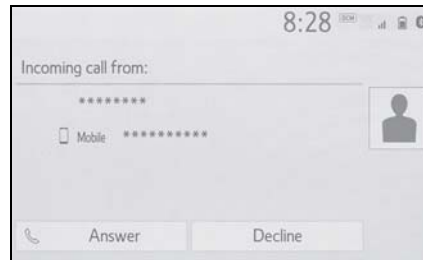

“Decline”: Select to refuse to receive the call.

To adjust the volume of a received call: Turn the “POWER VOLUME” knob, or use the volume control switch on the steering wheel.

- The contact image picture can be displayed only when the vehicle is not moving.
- During international phone calls, the other party’s name or number may not be displayed correctly depending on the type of Bluetooth® phone you have.
- The incoming call display mode can be set. (→P.482)
- The ringtone that has been set in the sound settings screen can be heard when there is an incoming call. Depending on the type of

Bluetooth® phone, both the system and Bluetooth® phone may ring simultaneously when there is an incoming call. (→P.481)

### Talking on the Bluetooth® hands-free system

While talking on the phone, the following screen is displayed. The operations outlined below can be performed on this screen.

### Call screen operation

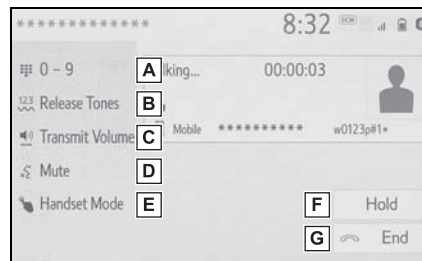

- A** Select to display the keypad to send tones. (→P.475)
- B** Select to send tones. This button only appears when a number that contains a (w) is dialed in hands-free mode. (→P.475)
- C** Select to adjust your voice volume that the other party hears from their speaker. (→P.475)
- D** Select to mute your voice to the other party.
- E** Select to change handset modes between hands-free and cellular phone.
- F** Select to put a call on hold.

To cancel this function, select “Activate”.

**G** Select to hang up the phone.

- Changing from hands-free call to cellular phone call is not possible while driving.
- Only when the vehicle is not moving, the contact image can be displayed.
- When cellular phone call is changed to hands-free call, the hands-free screen will be displayed and its functions can be operated on the screen.
- Changing between cellular phone call and hands-free call can be performed by operating the cellular phone directly.
- Transferring methods and operations will be different depending on the type of cellular phone you have.
- For the operation of the cellular phone, see the manual that comes with it.

### Sending tones

#### ■ By keypad

This operation cannot be performed while driving.

- 1 Select “0-9”.
- 2 Enter the desired number.

#### ■ By selecting “Release Tones”

“Release Tones” appear when a continuous tone signal(s) containing a (w) is registered in the contact list.

This operation can be performed while driving.

- 1 Select “Release Tones”.

- A continuous tone signal is a character string that consists of numbers and the characters “p” or “w”. (e.g. 056133w0123p#1)
- When the “p” pause tone is used, the tone data up until the next pause tone will be automatically sent after 2 seconds have elapsed. When the “w” pause tone is used, the tone data up until the next pause tone will be automatically sent after a user operation is performed.
- Release tones can be used when automated operation of a phone based service such as an answering machine or bank phone service is desired. A phone number with continuous tone signals can be registered in the contact list.
- Tone data after a “w” pause tone can be operated by voice command during a call.

### Transmit volume setting

- 1 Select “Transmit Volume”.
- 2 Select the desired level for the transmit volume.
- 3 Select  to display previous screen.

- The sound quality of the voice heard from the other party’s speaker may be negatively impacted.
- “Transmit Volume” is dimmed when mute is on.

### Switching calls while a call is in progress

- When there are no calls on hold during a call: “Hold” is displayed. When selected, the

current call is placed on hold.

- When there is no current call, but there is a call on hold: “Activate” is displayed. When selected, the system switches to the call that was on hold.
- When there is another call on hold during a call: “Swap Calls” is displayed. When selected, the current call is placed on hold, and the system switches to the call that was on hold.

- 
- This function may not be available depending on the type of cellular phone.

### Incoming call waiting

When a call is interrupted by a third party while talking, the incoming screen is displayed.

- 1 Select “Answer” or press the  switch on the steering wheel to start talking with the other party.
- To refuse to receive the call: Select “Decline”.
  - Each time “Swap Calls” is selected, the party who is on hold will be switched.

- 
- This function may not be available depending on the type of Bluetooth® phone.

### Bluetooth® phone message function

**Received messages can be forwarded from the connected Bluetooth® phone, enabling checking and replying using the system.**

**Depending on the type of Bluetooth® phone connected, received messages may not be transferred to the system.**

**If the phone does not support the message function, this function cannot be used. Even when the supported phone is used, reply function may not be used.**

### Displaying the message screen

- 1 Display the phone top screen. (→P.465)
  - 2 Select “Message”.
- A confirmation message appears when the “Automatic Message Transfer” function is set to off (→P.489), select “Yes”.
- 3 Check that the message screen is displayed.

“Phone”: Select to change to phone mode.

- The account name is displayed on the left side of

screen.

- Account names are the names of the accounts that exist on the currently connected phone.
- The following functions can be used on message function:
  - Receiving a message (→P.477)
  - Checking messages (→P.477)
  - Replying to a message (dictation reply) (→P.478)
  - Replying to a message (quick reply) (→P.479)
  - Calling the message sender (→P.479)
  - Message settings (→P.489)

### Receiving a message

When an e-mail/SMS/MMS is received, the incoming message screen pops up with sound and is ready to be operated on the screen.

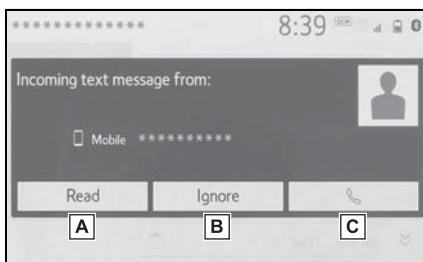

- A** Select to check the message.
- B** Select to not open the message.
- C** Select to call the message sender.

- Depending on the type of Bluetooth® phone used for receiving messages, or its registration status with the system, some information may not be displayed.
- The pop-up screen is separately available for incoming e-mail and SMS/MMS messages under the following conditions:

E-mail:

- “Incoming E-mail Display” is set to “Full Screen”. (→P.482)
- “E-mail Notification Pop-up” is set to on. (→P.482)

SMS/MMS:

- “Incoming SMS/MMS Display” is set to “Full Screen”. (→P.482)
- “SMS/MMS Notification Pop-up” is set to on. (→P.482)

- Depending on the type of Bluetooth® phone being connected, E-Mail function cannot be used via Bluetooth®.

### Checking received messages

- 1 Display the message screen. (→P.476)
- 2 Select a desired account name.
- 3 Select the desired message from the list.
- 4 Check that the message is displayed.



- A** Select to call the message sender.
- B** Select to have messages read out.  
To cancel this function, select "Stop".  
When "Automatic Message Readout" is set to on, messages will be automatically read out. (→P.489)
- C** Select to display the previous or next message.
- D** This function can be chosen the method to reply message with "Dictation" or "Quick Message".

- Reading a text message is not available while driving.
- Depending on the type of Bluetooth® phone being connected, this function cannot be used.
- Depending on the type of Bluetooth® phone being connected, it may be necessary to perform additional steps on the phone.
- Messages are displayed in the appropriate connected Bluetooth® phone's registered mail address folder. Select the desired folder to be displayed.
- Only received messages on the connected Bluetooth® phone can be displayed.
- The text of the message is not displayed while driving.
- Turn the "POWER VOLUME" knob, or use the volume control switch on the steering wheel to adjust the message read out volume.
- "Subject:" field is not shown on

SMS case.

- E-mail only: Select "Mark Unread" or "Mark Read" to mark mail unread or read on the message screen.  
This function is available when "Update Message Read Status on Phone" is set to on. (→P.489)

### Replying to a message (dictation reply)\*

\*: If equipped

- 1 Display the message screen. (→P.476)
  - 2 Select the desired message from the list.
  - 3 Select "Reply".
  - 4 Select "Dictation".
  - 5 When the "Say Your Message" screen is displayed, speak message that you want to send.
  - 6 Select "Send" to send message.
- "Cancel": Select to cancel sending the message.  
"Retry": Select to retry speaking message that you want to send.
- While the message is being sent, a sending message screen is displayed.
- 7 Check that a confirmation screen is displayed when the operation is complete.
- If an error message is displayed, follow the guidance on the screen to try again.

### Replying to a message (quick reply)

15 messages have already been stored.

- 1 Display the message screen. (→P.476)
- 2 Select the desired message from the list.
- 3 Select "Reply".
- 4 Select "Quick Message".
- 5 Select the desired message.

: Select to edit the message. (→P.479)

- 6 Select "Send".

"Cancel": Select to cancel sending the message.

- While the message is being sent, a sending message screen is displayed.
- 7 Check that a confirmation screen is displayed when the operation is complete.
- If an error message is displayed, follow the guidance on the screen to try again.

● Depending on the type of Bluetooth® phone, reply function is not available.

### Editing quick reply messages

This operation cannot be performed while driving.

- 1 Select  corresponding to the desired message to edit.

- 2 Select "OK" when editing is completed.



● To reset the edited quick reply messages, select "Default".

### Calling the message sender

Calls can be made to an e-mail/SMS/MMS message sender's phone number.

This operation can be performed while driving.

#### Calling from e-mail/SMS/MMS message display

- 1 Display the message screen. (→P.476)
  - 2 Select the desired message.
  - 3 Select , or press the  switch on the steering wheel.
- If there are 2 or more phone numbers, select the desired number.
- 4 Check that the dialing screen is displayed.

#### Calling from a number within a message

Calls can be made to a number identified in a message's text area.

This operation cannot be performed while driving.

- 1 Display the message screen. (→P.476)
- 2 Select the desired message.

- 3 Select the text area.

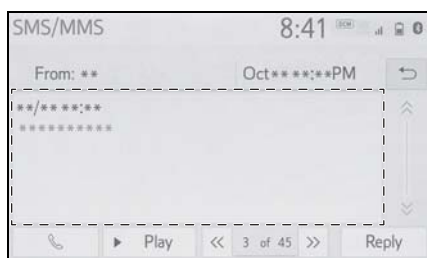

- Identified phone numbers contained in the message are displayed in blue text.
- 4 Select the desired number.
  - 5 Check that the dialing screen is displayed.

- 
- A series of numbers may be recognized as a phone number. Additionally, some phone numbers may not be recognized, such as those for other countries.

■ **Calling from the incoming message screen**

For detail, refer to “Receiving a message”. (→P.477)



Setup

Displaying the phone settings screen

- 1 Press the "MENU" button.

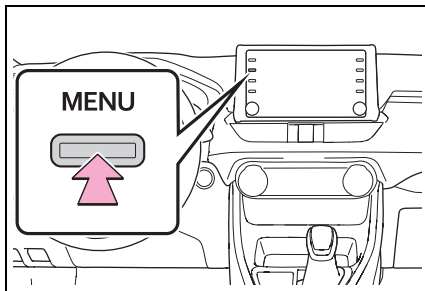

- 2 Select "Setup".
- 3 Select "Phone".
- 4 Select the desired item to be set.

Phone settings screen

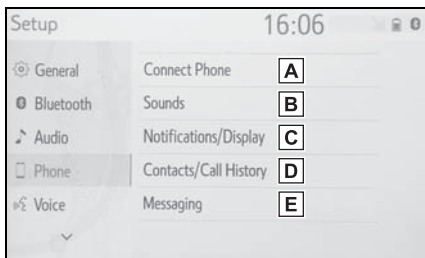

- A** Connecting a Bluetooth® device and editing the Bluetooth® device information (→P.395, 398)
- B** Sound settings\* (→P.481)
- C** Notifications/display settings\* (→P.482)
- D** Contact/call history settings\*

(→P.483)

- E** Message settings\* (→P.489)

\*: This operation cannot be performed while driving.

Sounds settings screen

The call and ringtone volume can be adjusted. A ringtone can be selected.

- 1 Display the phone settings screen. (→P.481)
- 2 Select "Sounds".
- 3 Select the desired item to be set.



- A** Select to set the desired ringtone.
- B** Select "-" or "+" to adjust the ringtone volume.
- C** Select "-" or "+" to adjust the default volume of the other party's voice.

5  
Audio

- D** Select to set the desired incoming e-mail tone.
- E** Select to set the desired incoming SMS/MMS tone.
- F** Select “-” or “+” to adjust the incoming SMS/MMS tone volume.
- G** Select “-” or “+” to adjust the incoming e-mail tone volume.
- H** Select “-” or “+” to adjust the message readout volume.
- I** Select to reset all setup items.

● Depending on the type of Bluetooth® phone, certain functions may not be available.

### Notifications/display settings screen

- 1 Display the phone settings screen. (→P.481)
- 2 Select “Notifications/Display”.

- 3 Select the desired item to be set.

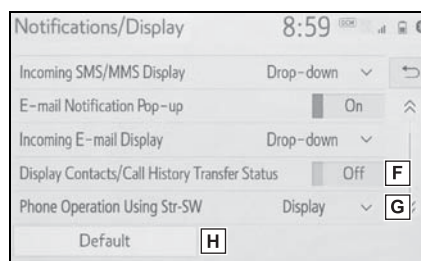
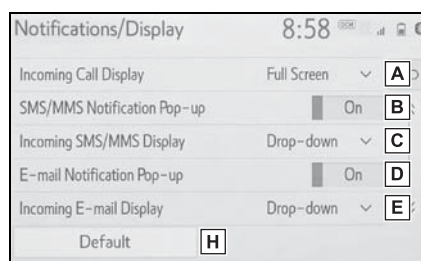

- A** Select to change the incoming call display.

“Full Screen”: When a call is received, the incoming call screen is displayed and can be operated on the screen.

“Drop-down”: A message is displayed at the top of the screen.

- B** Select to set the SMS/MMS notification pop-up on/off.

- C** Select to change the incoming SMS/MMS display.

“Full Screen”: When an SMS/MMS message is received, the incoming SMS/MMS display screen is displayed and can be operated on the screen.

“Drop-down”: When an SMS/MMS message is received, a message is displayed at the top of the

screen.

- D** Select to set the e-mail notification pop-up on/off.
- E** Select to change the incoming e-mail display.  
 “Full Screen”: When an e-mail is received, the incoming e-mail display screen is displayed and can be operated on the screen.  
 “Drop-down”: When an e-mail is received, a message is displayed at the top of the screen.
- F** Select to set display of the contact/history transfer completion message on/off.
- G** The phone top screen can be set to be displayed on the multi-information display or system screen.\*

\*: If equipped

- H** Select to reset all setup items.

● Depending on the type of Bluetooth® phone, these functions may not be available.

### Contacts/Call history settings screen

Contacts can be transferred from a Bluetooth® phone to this system. Contacts and favorites can be added, edited and deleted. Also, the call history can be deleted.

- 1 Display the phone settings screen. (→P.481)
- 2 Select “Contacts/Call History”.
- 3 Select the desired item to be set.



- A** For PBAP compatible Bluetooth® phones: Select to change the contact/history transfer settings. (→P.484)
- B** Select to update contacts from the connected device. (→P.485)
- C** Select to sort contacts by the first name or last name field.
- D** Select to add contacts to the favorites list. (→P.487)
- E** Select to delete contacts from the favorites list. (→P.488)
- F** Select to clear the call his-

tory.\*

- G** Select to add new contacts to the contact list.\* (→P.486)
- H** Select to edit contacts in the contact list.\* (→P.487)
- I** Select to delete contacts from the contact list.\* (→P.487)
- J** Select to set the voice tags. (→P.488)
- K** Select to reset all setup items.

\*: For PBAP compatible Bluetooth® phones, this function is available when “Automatic Transfer” is set to off. (→P.484)

- Depending on the type of Bluetooth® phone, certain functions may not be available.
- Contact data is managed independently for every registered phone. When one phone is connected, another phone’s registered data cannot be read.

#### Setting automatic contact/history transfer

The automatic contact/history function is available for PBAP compatible Bluetooth® phones only.

- 1 Select “Automatic Transfer”.

- 2 Select the desired item to be set.

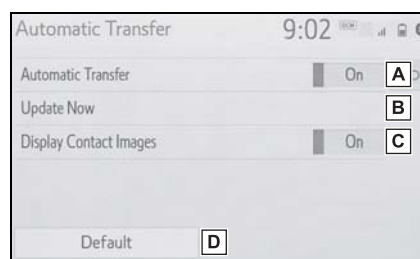

- A** Select to set automatic contact/history transfer on/off. When set to on, the phone’s contact data and history are automatically transferred.
- B** Select to update contacts from the connected phone. (→P.484)
- C** Select to set the transferred contact image display on/off. Only when the vehicle is not moving, the contact image can be displayed.
- D** Select to reset all setup items.

#### Updating contacts from phone

- 1 Select “Update Now”.
- Contacts are transferred automatically.
- 2 Check that a confirmation screen is displayed when the operation is complete.
- This operation may be unnecessary depending on the type of Bluetooth® phone.
  - If another Bluetooth® device

is connected when transferring contact data, depending on the phone, the connected Bluetooth® device may need to be disconnected.

- Depending on the type of Bluetooth® phone being connected, it may be necessary to perform additional steps on the phone.

#### ■ **Updating the contacts in a different way (from the call history screen)\***

- 1 Display the phone top screen. (→P.465)
- 2 Select “History” and select a contact not yet registered in the contact list.
- 3 Select “Update Contact”.
- 4 Select the desired contact.
- 5 Select a phone type for the phone number.

\*: For PBAP compatible Bluetooth® phones, this function is available when “Automatic Transfer” is set to off. (→P.484)

#### **Transfer contacts from device**

When an Android Auto connection is established, this function will be unavailable.\*

\*: This function is not made available in some countries or areas.

#### **From phone (OPP compatible Bluetooth® phones only)**

- ▶ When the contact is not registered

- 1 Select “Transfer Contacts from Device”.
- 2 Select “From Phone (Bluetooth)”.
- 3 Transfer the contact data to the system using a Bluetooth® phone.

- This operation may be unnecessary depending on the type of Bluetooth® phone.

- To cancel this function, select “Cancel”.

- 4 Check that a confirmation screen is displayed when the operation is complete.

- ▶ When the contact is registered

- 1 Select “Transfer Contacts from Device”.
- 2 Select “From Phone (Bluetooth)”.
- 3 Select “Replace Contacts” or “Add Contact”.

“Replace Contacts”: Select to transfer the contact from the connected cellular phone and replace the current one.

“Add Contact”: Select to transfer the desired contact data from the connected cellular phone to add to the current one.

- 4 Transfer the contact data to the system using a Bluetooth® phone.
  - This operation may be unnecessary depending on the type of Bluetooth® phone.
  - To cancel this function, select “Cancel”.
- 5 Check that a confirmation screen is displayed when the operation is complete.

#### From USB device

Backed-up contact data (“vCard” formatted) can be transferred from USB device or Bluetooth® phone to this system.

- 1 Connect a USB device. (→P.422)
- 2 Select “Transfer Contacts from Device”.
- 3 Select “From USB”.
- 4 Select “USB 1” or “USB 2” when the multiple USB devices are connected. If a USB device is connected, skip this procedure.
- 5 Select “Replace Contacts” or “Add Contact”. If the contact is already registered, skip this procedure.

“Replace Contacts”: Select to transfer the contact from the connected USB device or Bluetooth® phone and replace the current one.

“Add Contact”: Select to transfer

the desired contact data from the connected USB device or Bluetooth® phone to add to the current one.

- 6 Select a desired file from vCard file list.
- 7 Check that a confirmation screen is displayed when the operation is complete.

- Depending on the type of Bluetooth® phone used and number of files, it may take time to display vCard file lists and download contacts.
- Downloading may not complete correctly in the following cases:
  - If the engine switch is turned off during downloading.
  - If the USB device or Bluetooth® phone is removed before downloading is complete.

#### Registering a new contact to the contacts list

New contact data can be registered.

Up to 4 numbers per person can be registered. For PBAP compatible Bluetooth® phones, this function is available when “Automatic Transfer” is set to off. (→P.483)

- 1 Select “New Contact”.
- 2 Enter the name and select “OK”.
- 3 Enter the phone number and select “OK”.
- 4 Select the phone type for the phone number.

- 5 To add another number to this contact, select "Yes".

■ **Registering a new contact in a different way (from the call history screen)**

- 1 Display the phone top screen. (→P.465)
- 2 Select "History" and select a contact not yet registered in the contact list.
- 3 Select "Add to Contacts".
- 4 Follow the steps in "Registering a new contact to the contacts list" from step 2. (→P.486)

**Editing the contact data**

For PBAP compatible Bluetooth® phones, this function is available when "Automatic Transfer" is set to off. (→P.483)

- 1 Select "Edit Contact".
- 2 Select the desired contact.
- 3 Select  next to the name or desired number.
- 4 Enter the name or the phone number and select "OK".

**Deleting the contact data**

For PBAP compatible Bluetooth® phones, this function is available when "Automatic Transfer" is set to off. (→P.483)

- 1 Select "Delete Contacts".

- 2 Select the desired contact and select "Delete".
- 3 Select "Yes" when the confirmation screen appears.

● Multiple data can be selected and deleted at the same time.

● When a Bluetooth® phone is deleted, the contact data will be deleted at the same time.

**Favorites list setting**

Up to 15 contacts (maximum of 4 numbers per contact) can be registered in the favorites list.

■ **Registering the contacts in the favorites list**

- 1 Select "Add Favorite".
- 2 Select the desired contact to add to the favorites list.
- Dimmed contacts are already stored as a favorite.
- 3 Check that a confirmation screen is displayed when the operation is complete.
- ▶ When 15 contacts have already been registered to the favorites list

1 When 15 contacts have already been registered to the favorites list, a registered contact needs to be replaced. Select "Yes" when the confirmation screen appears to replace a contact.

- 2 Select the contact to be replaced.

- 3 Check that a confirmation screen is displayed when the operation is complete.

■ **Registering contacts in the favorites list in a different way (from the contact details screen)**

- 1 Display the phone top screen. (→P.465)
- 2 Select “Contacts” and select the desired contact.
- 3 Select “Add Favorite”.
- 4 Check that a confirmation screen is displayed when the operation is complete.

■ **Deleting the contacts in the favorites list**

- 1 Select “Remove Favorite”.
- 2 Select the desired contacts and select “Remove”.
- 3 Select “Yes” when the confirmation screen appears.
- 4 Check that a confirmation screen is displayed when the operation is complete.

■ **Deleting contacts in the favorites list in a different way (from the contact details screen)**

- 1 Display the phone top screen. (→P.465)
- 2 Select “Favorites” or “Contacts” and select the desired contact to delete.
- 3 Select “Remove Favorite”.

- 4 Select “Yes” when the confirmation screen appears.
- 5 Check that a confirmation screen is displayed when the operation is complete.

**Setting voice tags**

Calls can be made by saying the voice tag of a registered contact in the contact list. (→P.458)

- 1 Select “Manage Voice Tags”.
- 2 Select the desired item to be set.

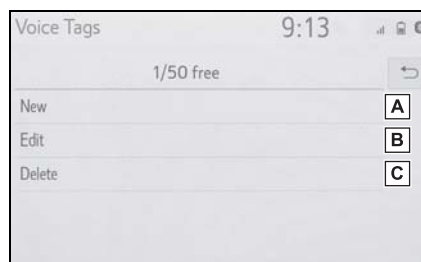

- A** Select to register a new voice tag. (→P.488)
- B** Select to edit a voice tag. (→P.489)
- C** Select to delete a voice tag. (→P.489)

■ **Registering a voice tag**

Up to 50 voice tags can be registered.

- 1 Select “New”.
  - 2 Select the desired contact to register a voice tag for.
  - 3 Select “REC” and record a voice tag.
- When recording a voice tag,



do so in a quiet area.

“Play”: Select to play the voice tag.

- 4 Select “OK” when voice tag registration is complete.

#### ■ Editing a voice tag

- 1 Select “Edit”.
- 2 Select the desired contact to edit.
- 3 Follow the steps in “Registering a voice tag” from step 3. (→P.488)

#### ■ Deleting the voice tag

- 1 Select “Delete”.
- 2 Select the desired contact and select “Delete”.
- 3 Select “Yes” when the confirmation screen appears.

- Multiple data can be selected and deleted at the same time.
- Voice tags are deleted when the set language of the system is changed. (→P.414)

### Message settings screen

- 1 Display the phone settings screen. (→P.481)
- 2 Select “Messaging”.

- 3 Select the desired item to be set.



- A Select to set automatic message transfer on/off.
- B Select to set automatic message readout on/off.
- C Select to set updating message read status on phone on/off.
- D Select to set display of messaging account names on the message screen on/off. When set to on, messaging account names used on the cellular phone will be displayed.
- E Select to set adding the vehicle signature to outgoing messages on/off. The vehicle signature can be edited. (→P.489)
- F Select to reset all setup items.

- Depending on the phone, these functions may not be available.

### Vehicle signature settings

- 1 Select “Vehicle Signature”.

- 2 Select the desired item to be set.



- A** Select to set adding the vehicle signature to outgoing messages on/off.
- B** Select to edit the vehicle signature. (→P.490)
- C** Select to reset all setup items.

#### ■ **Editing vehicle signature**

- 1 Select "Edit Vehicle Signature".
- 2 Enter desired signature with using keyboard.
- 3 Select "OK".
- 4 Select "OK" on the confirmation screen, or select "Edit Again" when it needs to amend.

**Troubleshooting**

**If there is a problem with the hands-free system or a Bluetooth® device, first check the table below.**

**Troubleshooting**

■ **When using the hands-free system with a Bluetooth® device**

The hands-free system or Bluetooth® device does not work.

Likely cause	Solution
The connected device may not be a compatible Bluetooth® cellular phone.	For a list of specific devices which operation has been confirmed on this system, check with your Toyota dealer or the following website: <a href="http://www.toyota.com/audio-multimedia">http://www.toyota.com/audio-multimedia</a> in the United States, <a href="http://www.toyota.ca/connected">http://www.toyota.ca/connected</a> in Canada, and <a href="http://www.toyotapr.com/audio-multimedia">http://www.toyotapr.com/audio-multimedia</a> in Puerto Rico
The Bluetooth® version of the connected cellular phone may be older than the specified version.	Use a cellular phone with Bluetooth® version 2.0 or higher (recommended: Ver. 4.2 or higher). (→P.393)

■ **When registering/connecting a cellular phone**

A cellular phone cannot be registered.

Likely cause	Solution
An incorrect passcode was entered on the cellular phone.	Enter the correct passcode on the cellular phone.
The registration operation has not been completed on the cellular phone side.	Complete the registration operation on the cellular phone (approve registration on the phone).
Old registration information remains on either this system or the cellular phone.	Delete the existing registration information from both this system and the cellular phone, then register the cellular phone you wish to connect to this system. (→P.397)



A Bluetooth® connection cannot be made.

Likely cause	Solution
Another Bluetooth® device is already connected.	Manually connect the cellular phone you wish to use to this system. (→P.395)
Bluetooth® function is not enabled on the cellular phone.	Enable the Bluetooth® function on the cellular phone.

Likely cause	Solution
Automatic Bluetooth® connection on this system is set to off.	Set automatic Bluetooth® connection on this system to on when the engine switch is in ACC or ON. (→P.400)
Preferred device settings function on this system is set to on.	Set preferred device settings function on this system to off. (→P.400) Set the desired cellular phone to the highest automatic connection priority. (→P.400)

■ **When making/receiving a call**

A call cannot be made/received.

Likely cause	Solution
Your vehicle is in a  area.	Move to where  no longer appears on the display.

■ **When using the phonebook**

Phonebook data cannot be transferred manually/automatically.

Likely cause	Solution
The profile version of the connected cellular phone may not be compatible with transferring phonebook data.	For a list of specific devices which operation has been confirmed on this system, check with your Toyota dealer or the following website: <a href="http://www.toyota.com/audio-multimedia">http://www.toyota.com/audio-multimedia</a> in the United States, <a href="http://www.toyota.ca/connected">http://www.toyota.ca/connected</a> in Canada, and <a href="http://www.toyotapr.com/audio-multimedia">http://www.toyotapr.com/audio-multimedia</a> in Puerto Rico
Automatic contact transfer function on this system is set to off.	Set automatic contact transfer function on this system to on. (→P.484)
Passcode has not been entered on the cellular phone.	Enter the passcode on the cellular phone if requested (default passcode: 1234).
Transfer operation on the cellular phone has not completed.	Complete transfer operation on the cellular phone (approve transfer operation on the phone).

Phonebook data cannot be

edited.

Likely cause	Solution
Automatic contact transfer function on this system is set to on.	Set automatic contact transfer function on this system to off. (→P.484)

■ **When using the Bluetooth® message function**

Messages cannot be viewed.

Likely cause	Solution
Message transfer is not enabled on the cellular phone.	Enable message transfer on the cellular phone (approve message transfer on the phone).
Automatic transfer function on this system is set to off.	Set automatic transfer function on this system to on. (→P.484)

New message notifications are not displayed.

Likely cause	Solution
Notification of SMS/MMS/E-mail reception on this system is set to off.	Set notification of SMS/MMS/E-mail reception on this system to on. (→P.482)
Automatic message transfer function is not enabled on the cellular phone.	Enable automatic transfer function on the cellular phone.

■ In other situations

The Bluetooth® connection status is displayed at the top of the screen each time the engine switch is in ACC or ON.

Likely cause	Solution
Connection confirmation display on this system is set to on.	To turn off the display, set connection confirmation display on this system to off. (→P.400)

Even though all conceivable measures have been taken, the symptom status does not change.

Likely cause	Solution
The cellular phone is not close enough to this system.	Bring the cellular phone closer to this system.
Radio interference has occurred.	Turn off Wi-Fi® devices or other devices that may emit radio waves.

Likely cause	Solution
The cellular phone is the most likely cause of the symptom.	Turn the cellular phone off, remove and reinstall the battery pack, and then restart the cellular phone.
	Enable the cellular phone's Bluetooth® connection.
	Disable the W-Fi® connection of the cellular phone.
	Stop the cellular phone's security software and close all applications.
	Before using an application installed on the cellular phone, carefully check its source and how its operation might affect this system.

- For details, refer to the owner's manual that came with the cellular phone.

**Connected Services\***

\*: This function is not made available in some countries or areas.

**Connected Services includes Toyota Apps, Service Connect, Wi-Fi® Hotspot, Safety Connect and Remote Connect.**

**Functional overview**

- The functions included are classified into the following four types.
- Type A: Function achieved by using a smartphone or an embedded cellular device in the vehicle (DCM: Data Communication Module) and the system
- Type B: Function achieved by using DCM and the system
- Type C: Function achieved by using DCM
- Type D: Function achieved by using DCM and a smartphone

Function	Type
Toyota Apps	Type A
Wi-Fi® Hotspot	Type B
Safety Connect	Type C
Remote Connect, Service Connect	Type D

- Connected Services functionality is dependent upon network reception level and signal strength.
- Each function is available in the following areas:

- Toyota Apps is available in the contiguous United States, Washington D.C. and Alaska.
- Wi-Fi® Hotspot is available in the contiguous United States, Washington D.C. and Alaska.
- Safety Connect is available in the contiguous United States, Washington D.C. and Alaska.
- Remote Connect is available in the contiguous United States, Washington D.C. and Alaska.
- Service Connect is available in the contiguous United States, Washington D.C. and Alaska.

Type A: Function achieved by using a smartphone or DCM

**Of the functions included with Connected Services, the Toyota Apps rely on the use of a smartphone or DCM.**

- Using a smartphone
  - Toyota audio multimedia system enables applicable apps installed on a smartphone to be displayed on and operated from the screen via a Bluetooth®.
- Via DCM
  - Toyota audio multimedia system enables applicable apps installed on the system to be displayed on and operated from the screen.

**A few settings must be performed before Toyota Apps can be used. (→P.498)**

By using a smartphone or DCM

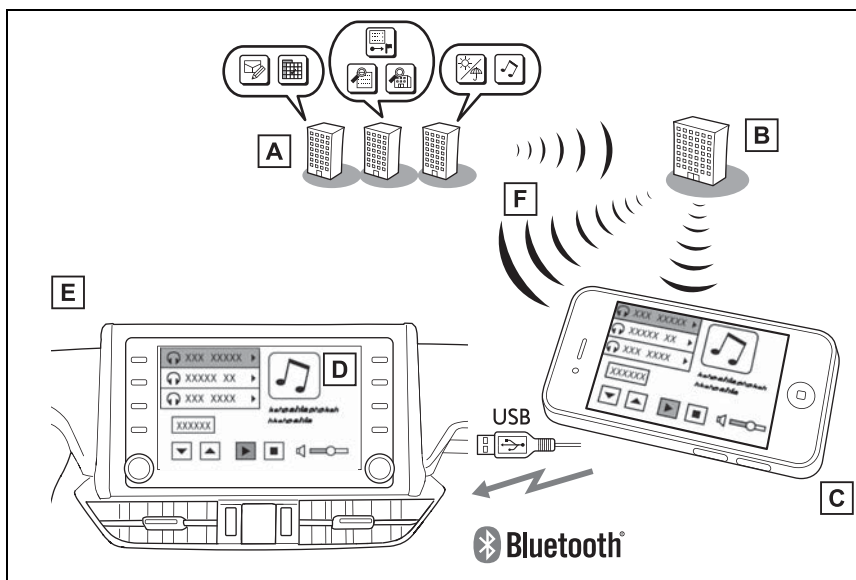

- A** Content provider  
Provides contents to the application server.
- B** Application server



Provides applications to the system or a smartphone.

**C** Smartphone\*

Using the Toyota mobile application, communication is relayed between the system, application server and content provider.

**D** Applications

Display usable content from the content providers on the screen using the data connection of the connected smartphone or DCM.

**E** System

Content received, via a smartphone or DCM, from content provider servers is displayed on the screen. The system is equipped with an application player to run applications.

**F** Via DCM

\*: For known compatible phones, refer to <http://www.toyota.com/connected-services> in the United States.

**Before using the function**

The required operations to activate applications and connect a smartphone to the system, and the registration steps for the Connected Services are explained in this section.

■ **Subscription**

- Services requiring a separate contract can also be used.\*

\*: For details, refer to <http://www.toyota.com/connected-services> or call 1-800-331-4331 in the United States.

■ **Availability of function**

- Toyota Apps is available in the contiguous United States, Washington D.C. and Alaska.

- Data usage fees may apply while using Toyota Apps. Confirm data

usage fees before using this function.

- For details regarding operation of the Toyota Apps, refer to <http://www.toyota.com/connected-services> in the United States.
- These functions are not made available in some countries or areas. Availability of functions of the Toyota Apps is dependent on network reception level.

■ **Initializing personal data**

The personal data used in applications can be reset. (→P.417)

- The following personal data can be deleted and returned to their default settings:
  - Downloaded contents
  - Radio stations that were listened to

- Once initialized, the data and settings will be erased. Pay much attention when initializing the data.

### Preparation before using Toyota mobile application

#### ■ Settings required to use Toyota mobile application

Perform the settings in the following order.

- 1 Download the Toyota mobile application to your smartphone.
- 2 Open the Toyota mobile application on your smartphone and follow instructions. Bluetooth® Pairing is required.

In order to use Toyota mobile application, the following must first be performed:

- Register a Bluetooth® phone with the hands-free system. (→P.390)
- 
- Applications can only be used when the Toyota mobile application has been downloaded to your smartphone, and the application is running.
  - Toyota mobile application operational procedures can also be confirmed by visiting <http://www.toyota.com/connected-services> in the United States.
  - If a Toyota mobile application is used while iPod audio/video is being played back, system operation may become unstable.

### Type B: Function achieved by using DCM and the system\*

\*: Vehicles equipped with DCM

#### The functionality of Wi-Fi® Hotspot is made possible through the shared work of the DCM and the system.

These are subscription-based telematics services that use Global Positioning System (GPS) data and embedded cellular technology to provide safety and security as well as convenience features.

These services are available by subscription on select, telematics hardware-equipped vehicles and supported by the Toyota response center, which operates 24 hours a day, 7 days a week.

For details about Wi-Fi® Hotspot: →P.402

### Before using the function

#### ■ Subscription

- After you have signed the Telematics Subscription Service Agreement and are enrolled, you can begin receiving services. A variety of subscription terms are available. Contact your Toyota

dealer, or call 1-800-331-4331 in the United States, for further subscription details. (→P.497)

■ **Availability of functions**

- Wi-Fi® Hotspot is available in the contiguous United States, Washington D.C. and Alaska.

Type C: Function achieved by using DCM\*

\*: Vehicles equipped with DCM

**The functionality of Safety Connect is made possible by the use of a DCM.**

**For details, (→P.65)**

- **Free/Open Source Software Information**  
This product contains Free/Open Source Software (FOSS). The license information and/or the source code of such FOSS can be found at the following URL. <http://opensource.lge.com>
- **Exposure to radio frequency signals:**  
The Toyota audio multimedia system installed in your vehicle includes a low power radio transmitter and receiver. The system receives and also sends out radio frequency (RF) signals.
- In August 1996, the Federal Communications Commission (FCC) adopted RF exposure guidelines with safety levels for mobile wireless phones. Those guidelines are consistent with the safety standards previously set by both U.S. and international standards bodies.
  - ANSI (American National Standards Institute) C95.1 [1992]
  - NCRP (National Council on Radiation Protection and Measurement) Report 86 [1986]
  - ICNIRP (International Commission on Non-Ionizing Radiation Protection) [1996]
- These standards are based on comprehensive and periodic evaluations of the relevant scientific literature. Over 120 scientists, engineers, and physicians from

5  
Audio

universities, government health agencies, and industry reviewed the available body of research to develop the ANSI Standard (C95.1).

- The design of Toyota audio multimedia system complies with the FCC guidelines in addition to those standards.
- Contact with the Toyota response center is dependent upon the telematics device being in operative condition, cellular connection availability and GPS satellite signal reception, which can limit the ability to reach the Toyota response center or receive support. Enrollment and Telematics Subscription Service Agreement required. A variety of subscription terms are available; charges vary by subscription term selected.
- The Toyota response center offers support in multiple languages.
- Select Safety Connect-subscribed vehicles are capable of communicating vehicle information. Please see the terms and conditions for additional details. Owners who do not wish to have their vehicle transmit this information can opt out at the time of enrollment or by calling 1-800-331-4331 in the United States, and following the prompts for Safety Connect.
- For further details about the service, contact your Toyota dealer.
- Toyota audio multimedia are not subject to section 255 of the Telecommunications Act and the system is not TTY compatible.

- Certification
- ▶ For vehicles sold in the U.S.A.

FCC ID: BEJTL19BNN  
IC: 2703H-TL19BNN

**FCC/IC WARNING:**

Changes or modifications not expressly approved by the manufacture could void the user's authority to operate the equipment.

This device complies with Part 15 of the FCC Rules and Industry Canada license-exempt RSS standards. Operation is subject to the following two conditions:

- (1) this device may not cause harmful interference, and
- (2) this device must accept any interference, including interference that may cause undesired operation of the device.

This equipment complies with IC RSS-102 radiation exposure limits set forth for uncontrolled environment.

The antennas used for this transmitter must be installed to provide a separation distance of least 20cm from all persons.

**FCC/IC AVERTISSEMENT:**

L'utilisateur est averti que les changements ou modifications non expressément approuvés par le fabricant pourraient annuler l'autorité de l'utilisateur à utiliser l'équipement.

Ce appareil est compatible avec la Partie 15 du règlement FCC et de la Licence de l'industrie canadienne et des normes exemptes de RSS. Opération soumise aux deux conditions suivantes :

- (1) ce appareil ne doit pas causer des interférences nuisibles, et
- (2) cet appareil doit accepté toutes les interférences, y compris les interférences qui peuvent entraîner un fonctionnement indésirable de l'appareil.

Cet appareil est compatible aux limites d'exposition aux radiation IC RSS-102 définies pour un environnement non contrôlé.

Les antennes utilisées pour cet émetteur doivent être installées à une distance d'au moins 20 cm de toutes les personnes.

Type D: Function achieved by using DCM and a smart-phone

The functionality of Remote Connect and Service Connect are made possible by the use of a DCM and a smartphone.

For details about these services, refer to <http://www.toyota.com/connected-services>.

### Remote Connect\*

\*: Vehicles equipped with remote connect only

Remote Connect is a service that lets you view and remotely control certain aspects of your vehicle.

#### ■ Subscription

- After you sign the Telematics Subscription Service Agreement (see the Safety Connect section →P.65), download the Toyota App from your smartphone app store, and register within the app (or enroll and complete registration at the dealer), you can begin using these services.
- A variety of subscription terms are available. Contact your Toyota dealer, or call 1-800-331-4331 for further subscrip-

tion details.

#### ■ Availability of function

- Remote Connect is available in the contiguous United States, Washington D.C. and Alaska.

- Availability of functions of the Remote Connect is dependent on network reception level.
- Remote Connect should only be used by authorized users.
- Laws in some communities may require that the vehicle be within view of the user when operating Remote Connect. In some states, use of Remote Connect may violate state or local laws. Before using Remote Connect, check your state and local laws.
- Any malfunction of the vehicle should be repaired by your Toyota dealer.
- Remote Connect is designed to work at temperatures above approximately -22 °F (-30 °C). This specification is related to the Remote Connect operation, but is dependent on the vehicle's operating temperature range which may be different.
- Content is subject to change without notice.
- Additional information can be found at <http://www.toyota.com/connected-services> in the United States.

#### WARNING

- Operating Remote Connect incorrectly may lead to unforeseen accidents or malfunctions. Check the vehicle condition and assume full responsibility before using.

## Service Connect

Service Connect uses DCM to collect and transmit vehicle data that allows Toyota to provide:

- Vehicle Health Report (VHR) (Safety Recalls, Service Campaigns, Current Vehicle Alerts, Required Maintenance, and Vehicle Condition Status)
- Maintenance Notifications
- Vehicle Alert Notifications

### ■ Availability of function

- Service Connect is available in the contiguous United States, Washington D.C. and Alaska.
- 
- Availability of functions of the Service Connect is dependent on network reception level.

## Toyota Apps

**Toyota Apps is a function that enables certain apps installed on a smartphone or the system to be displayed on and operated from the system screen. Before the Toyota Apps can be used, some setup needs to be performed. (→P.498)**

**For details about the functions and services provided by each application, refer to <http://www.toyota.com/connected-services> in the United States.**

## Using Toyota Apps

- ▶ From the “MENU” button
- 1 Press the “MENU” button.

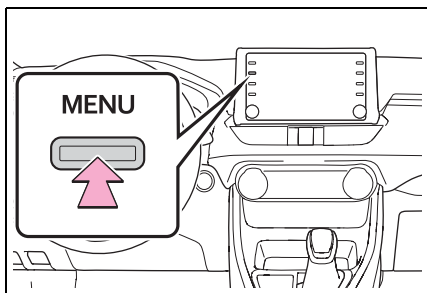

- 2 Select “Apps”.
- 3 Follow the steps in “From the “APPS” button” from step 2. (→P.504)

- ▶ From the “APPS” button
- 1 Press the “APPS” button.

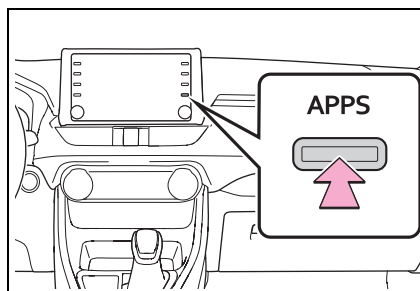

- If a specific application screen is displayed, press the “APPS” button again.
- 2 Select the desired application screen button.

: Select to activate an application.

“Update”: Select to update the applications. (→P.504)

: Displays the number of new notifications for the application

## Updating an application

When the Toyota Apps is activated, an application may need to be updated. To update an application, it is necessary to download update data and install it.

### ■ Downloading update

If an update is available, “Update” can be selected.

- 1 Select “Update” on the application screen. (→P.504)
- 2 Check that downloading starts.



“Download in Background”: Select to operate other functions while downloading.

“Cancel”: Select to cancel updating.

- 3 Check that downloading is complete.

“Later”: Select to install later. When this screen button is selected, the screen will return to the last displayed screen. To install the update data: (→P.505)

“See Detail”: Select to display detailed information on the update data.

“Install”: Select to install the update data. Follow the steps “Installing the update data” from step 2. (→P.505)

**■ Installing the update data**

After the downloading is complete, “Update” will be changed to “Install”.

- 1 Select “Install” on the application screen. (→P.504)
- 2 Select “Continue”.

“Later”: Select to postpone the installation of the update data and go back to the previous screen.

- 3 Check that installing is started.

“Install in Background”: Select to operate other functions while installing.

- 4 Select “OK” after the installing is complete.

- The Toyota Apps cannot be operated while installing.

**If a message appears on the screen**

When problems occur with start-

ing the application player, a message will appear on the screen. Referring to the table below, identify the problem and take the suggested corrective action.

- “When it is safe and legal to do so, please ensure your Toyota mobile application is running and logged in on your phone.”

The Toyota mobile application cannot be connected to Bluetooth® SPP.

Refer to

<http://www.toyota.com/connected-services>

in the United States, to confirm if the phone is Bluetooth® SPP compatible or not, and then activate the Toyota mobile application.

- “Installation failed, please try again”

Installation can be attempted again by changing to the application screen and pressing the “Install” switch.

- “Application download error. Please try again later.”

Downloading can be attempted again by checking the communication status, changing to the application screen and pressing the “Download” switch again.

- “Download error, some Toyota mobile application functions may not work as expected. Please reinitiate the download process.”

The Toyota mobile application cannot be connected to Bluetooth® SPP.

Refer to <http://www.toyota.com/connected-services> in the United States, to confirm if the phone is Bluetooth® SPP compatible or not, and then activate the Toyota mobile application.

Please ensure your Toyota mobile application is running and logged in on your phone while vehicle is not moving.

- “To use the services, Toyota mobile application needs to be running on your phone. For more information, please visit [toyota.com](http://toyota.com) or call 1-800-331-4331 in the United States.”

The Toyota mobile application cannot be connected to Bluetooth® SPP.

Refer to <http://www.toyota.com/connected-services> in the United States, to confirm if the phone is Bluetooth® SPP compatible or not, and then activate the Toyota mobile application.

- “Communication unsuccessful. Please try again.”

Communication was disconnected. After a few moments, retry the operation.

### Entering keyword operation

A keyword can be entered to an application by the software keyboard or voice recognition function. For details about the functions and services provided by each application, refer to <http://www.toyota.com/connected-services> in the United States.

- The keyboard layout can be changed. (→P.414)

### Entering a keyword using the software keyboard

- 1 Display the application screen. (→P.504)
- 2 Select the desired application screen button.
- 3 Select the character entering space.
- 4 Enter a search term, and then select “OK”.
- 5 Entering characters will be reflected on the character entering space.

- For details on operating the keyboard: →P.385

### Entering a keyword using the voice recognition function

- 1 Display the application screen. (→P.504)

- 2 Select the desired application screen button.
- 3 Press the talk switch.  
(→P.458)
- 4 Say the desired keyword.
- Completion of the keyword will be detected automatically.
- 5 Search results will be displayed on the screen.

5

Audio

## Toyota Apps settings

Toyota Apps settings can be changed.

### Displaying the Toyota Apps settings screen

- 1 Press the "MENU" button.

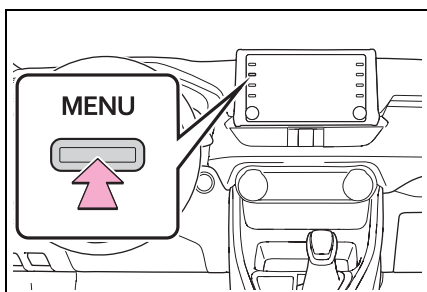

- 2 Select "Setup".
- 3 Select "Toyota Apps".
- 4 Select the desired items to be set.

### Toyota Apps settings screen



- A** Select to set the pop up reminder for smartphone data usage. (→P.508)
- B** Select to detect iPhone app automatically on/off.

- C** Select to turn on/off the enhanced USB connection mode.
  - When an iPhone is connected while this setting is "On", communication with any devices connected to the other USB port is not possible. Also, depending on the device, charging may not be possible.
- D** Select to reset all setup items to default setting

### Data usage notification pop-up settings

The data usage notification pop-up, which indicates that the system will use an internet connection, can be enabled/disabled.

- 1 Display the Toyota Apps settings screen. (→P.508)
- 2 Select "Data Usage Message".
- 3 Change the setting as desired.

**Interior features****6****6-1. Using the air conditioning system and defogger**

Manual air conditioning system ..... 510

Automatic air conditioning system..... 515

Heated steering wheel/seat heaters/seat ventilators ..... 522

**6-2. Using the interior lights**

Interior lights list ..... 525

**6-3. Using the storage features**

List of storage features 528

Luggage compartment features ..... 532

**6-4. Using the other interior features**

Other interior features . 537

Garage door opener.... 548

Manual air conditioning system\*

\*: If equipped

Air conditioning controls

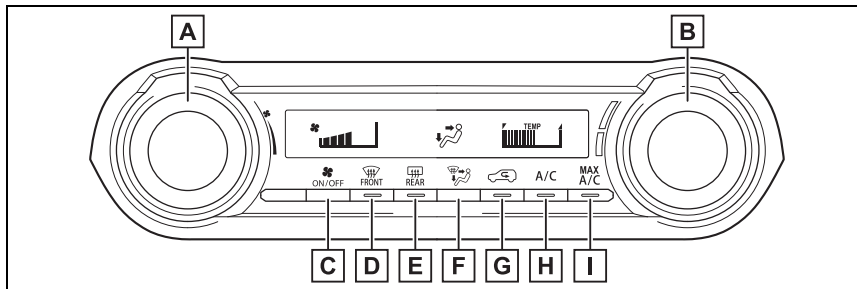

- A** Fan speed control switch
- B** Temperature control switch
- C** On/off switch
- D** Windshield defogger switch
- E** Rear window defogger and outside rear view mirror defoggers\* switch
- F** Airflow mode control switch
- G** Outside/recirculated air mode switch
- H** "A/C" switch
- I** "MAX A/C" switch

\*: If equipped

■ **Adjusting the temperature setting**

To adjust the temperature setting, turn the temperature control switch clockwise (warm) or counterclockwise (cool).

If "A/C" switch is not pressed, the system will blow ambient temperature air or heated air.

■ **Fan speed setting**

To adjust the fan speed, turn the fan speed control switch clockwise (increase) or counterclockwise (decrease).

Pressing the on/off switch turns off the fan.

When the fan is off, pressing the on/off switch or turning the fan speed control switch will turn on the

fan.

### ■ Change the airflow mode

Press the airflow mode control switch.

The airflow mode changes as follows each time the switch is pressed.

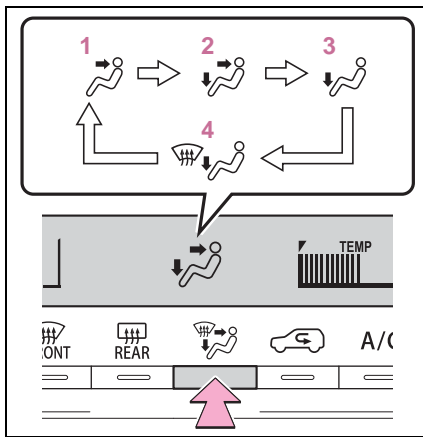

- 1 Upper body
- 2 Upper body and feet
- 3 Feet
- 4 Feet and the windshield defogger operates

### ■ Switching between outside air and recirculated air modes

Press the outside/recirculated air mode switch.

The mode switches between outside air mode and recirculated air mode each time the switch is operated.

When recirculated air mode is selected, the indicator illuminates on the outside/ recirculated air mode switch.

### ■ Set cooling and dehumidification function

Press the "A/C" switch.

When the function is on, the indicator illuminates on the "A/C" switch.

### ■ Defogging the windshield

Defoggers are used to defog the windshield and front side windows.

Press the windshield defogger switch.

Set the outside/recirculated air mode switch to outside air mode if the recirculated air mode is used.

To defog the windshield and the side windows quickly, turn the air flow and temperature up.

To return to the previous mode, press the windshield defogger switch again when the windshield is defogged.

When the windshield defogger switch is on, the indicator illuminates on the windshield defogger switch.

### ■ Defogging the rear window and outside rear view mirrors (if equipped)

Defoggers are used to defog the rear window, and to remove raindrops, dew and frost from the outside rear view mirrors (if equipped).

Press the rear window defogger and outside rear view mirror defoggers switch.

When the rear window defogger and outside rear view mirror defog-

gers switch is on, the indicator illuminates on the rear window defogger and outside rear view mirror defoggers switch.

The defoggers will automatically turn off after a while.

---

#### ■ For quick cooling

Press the "MAX A/C" switch. The air conditioning will automatically turn on.

At this time, the following will occur:

- The recirculated air mode will be set
- The windshield defogger will turn off
- The air flow mode will change to the upper body mode

#### ■ Operation of the air conditioning system in Eco drive mode

In Eco drive mode, the air conditioning system is controlled to prioritize fuel efficiency by regulating the engine speed and compressor operation to restrict the heating/cooling capacity.

To improve air conditioning performance, perform the following operations:

- Adjust the fan speed
- Adjust the temperature setting
- Turn off Eco drive mode (→P.351)

#### ■ Fogging up of the windows

- The windows will easily fog up when the humidity in the vehicle is high. Turning the "A/C" switch on will dehumidify the air from the outlets and defog the windshield effectively.
- If you turn the "A/C" switch off, the windows may fog up more easily.
- The windows may fog up if the recirculated air mode is used.

#### ■ When driving on dusty roads

Close all windows. If dust thrown up

by the vehicle is still drawn into the vehicle after closing the windows, it is recommended that the air intake mode be set to outside air mode and the fan speed to any setting except off.

#### ■ Outside/recirculated air mode

Setting to the recirculated air mode temporarily is recommended in preventing dirty air from entering the vehicle interior and helping to cool the vehicle when the outside air temperature is high.

#### ■ When the outside temperature falls to nearly 32°F (0°C)

The dehumidification function may not operate even when the "A/C" switch is pressed.

#### ■ Ventilation and air conditioning odors

- To let fresh air in, set the air conditioning system to the outside air mode.
- During use, various odors from inside and outside the vehicle may enter into and accumulate in the air conditioning system. This may then cause odor to be emitted from the vents.
- To reduce potential odors from occurring:  
It is recommended that the air conditioning system be set to outside air mode prior to turning the vehicle off.
- When parking, the system automatically switches to outside air mode to encourage better air circulation throughout the vehicle, helping to reduce odors that occur when starting the vehicle.

#### ■ Air conditioning system operations when the engine is stopped due to the Stop & Start system (vehicles with Stop & Start system)

When the engine is stopped due to the Stop & Start system operations, the air conditioning cooling, heating



and dehumidification functions turn off and only ambient temperature air is blown, and there is a possibility that the blowing of ambient temperature air will stop. To prevent the air conditioning system from turning off, press the Stop & Start cancel switch to deactivate the system.

■ **When the windshield is fogged up and the engine is stopped due to the Stop & Start system (vehicles with Stop & Start system)**

Press the windshield defogger switch to restart the engine and defog the windshield.

If the windshield continuously fogs up, press the Stop & Start cancel switch and refrain from using the Stop & Start system.

■ **When an odor comes from the air conditioning system while the engine is stopped due to the Stop & Start system (vehicles with Stop & Start system)**

Press the Stop & Start cancel switch to restart the engine.

■ **Air conditioning filter**

→P.599

**! WARNING**

■ **To prevent the windshield from fogging up**

Do not use the windshield defogger switch during cool air operation in extremely humid weather. The difference between the temperature of the outside air and that of the windshield can cause the outer surface of the windshield to fog up, blocking your vision.

■ **When the outside rear view mirror defoggers are operating (if equipped)**

Do not touch the rear view mirror surfaces when the outside rear view mirror defoggers are on.

**! NOTICE**

■ **To prevent battery discharge**

Do not leave the air conditioning system on longer than necessary when the engine is off.

**Air outlet layout and operations**

■ **Location of air outlets**

The air outlets and air volume change according to the selected airflow mode.

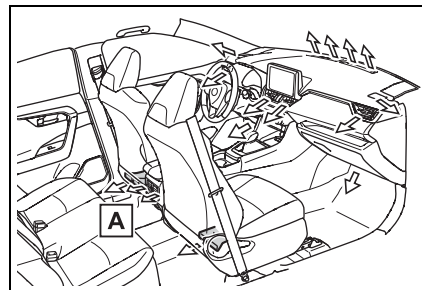

A If equipped

■ **Adjusting the air flow direction and opening/closing the air outlets**

► Front

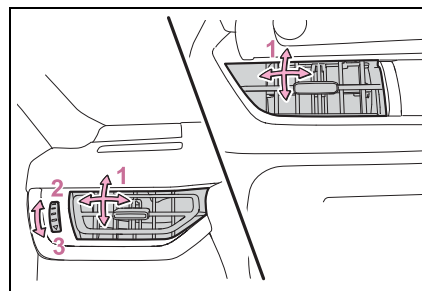

1 Direct air flow to the left or right, up or down.

2 Open the vent

- 3 Close the vent
- ▶ Rear (if equipped)

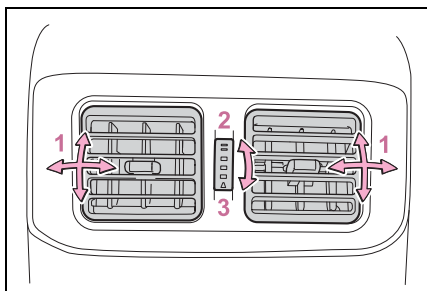

- 1 Direct air flow to the left or right, up or down
- 2 Open the vent
- 3 Close the vent

**⚠ WARNING**

■ **To not interrupt the windshield defogger from operating**

Do not place anything on the instrument panel which may cover the air outlets. Otherwise, air flow may be obstructed, preventing the windshield defoggers from defogging.

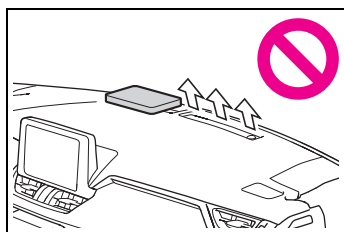

## Automatic air conditioning system

Air outlets and fan speed are automatically adjusted according to the temperature setting.

## Air conditioning controls

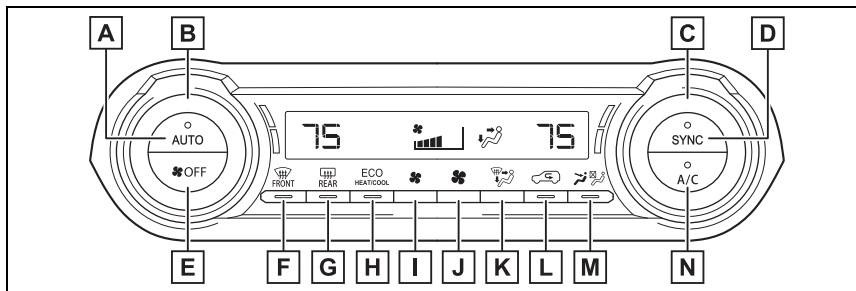

- A** Automatic mode switch
  - B** Left-hand side temperature control knob
  - C** Right-hand side temperature control knob
  - D** “SYNC” switch
  - E** “OFF” switch
  - F** Windshield defogger switch
  - G** Rear window defogger and outside rear view mirror defoggers switch
  - H** Eco air conditioning mode switch
  - I** Fan speed decrease switch
  - J** Fan speed increase switch
  - K** Airflow mode control switch
  - L** Outside/recirculated air mode switch
  - M** S-FLOW mode switch
  - N** “A/C” switch
- **Adjusting the temperature setting**
- Turn driver’s side temperature control dial clockwise to increase the temperature and turn the dial counterclockwise to

decreases the temperature.

The air conditioning system switches between individual and simultaneous modes each time the “SYNC” switch is pressed.

Simultaneous mode (the indicator on the “SYNC” switch is on):

The driver’s side temperature control dial can be used to adjust the temperature for the driver’s and passenger’s side. At this time, operate the passenger’s side temperature control dial to enter individual mode.

Individual mode (the indicator on the “SYNC” switch is off):

The temperature for the driver’s and passenger’s side can be adjusted separately.

#### ■ Setting the fan speed

Press the fan speed increase switch to increase the fan speed and the fan speed decrease switch to decrease the fan speed.

Pressing the “OFF” switch turns off the fan.

#### ■ Change the airflow mode

Press the airflow mode control switch.

The airflow mode changes as follows each time the switch is pressed.

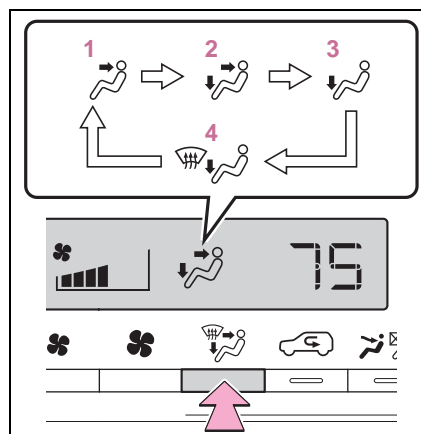

- 1 Upper body
- 2 Upper body and feet
- 3 Feet
- 4 Feet and the windshield defogger operates

#### ■ Switching between outside air and recirculated air modes

Press the outside/recirculated air mode switch.

The mode switches between outside air mode and recirculated air mode each time the switch is operated.

When recirculated air mode is selected, the indicator illuminates on the outside/ recirculated air mode switch.

#### ■ Set cooling and dehumidification function

Press the “A/C” switch.

When the function is on, the indicator illuminates on the “A/C” switch.

#### ■ Eco air conditioning mode

The air conditioning is controlled with low fuel consumption priori-

tized such as reducing fan speed, etc.

Press the eco air conditioning mode switch.

When the eco air conditioning mode is on, the indicator illuminates on the eco air conditioning mode switch.

#### ■ Defogging the windshield

Defoggers are used to defog the windshield and front side windows.

Press the windshield defogger switch.

Set the outside/recirculated air mode switch to outside air mode if the recirculated air mode is used. (It may switch automatically.)

To defog the windshield and the side windows quickly, turn the air flow and temperature up.

To return to the previous mode, press the windshield defogger switch again when the windshield is defogged.

When the windshield defogger switch is on, the indicator illuminates on the windshield defogger switch.

#### ■ Defogging the rear window and outside rear view mirrors (if equipped)

Defoggers are used to defog the rear window and to remove raindrops, dew and frost from the outside rear view mirrors (if equipped).

Press the rear window defogger and outside rear view mirror

defoggers switch.

The defoggers will automatically turn off after 15 minutes.

When the rear window defogger and outside rear view mirror defoggers switch is on, the indicator illuminates on the rear window defogger and outside rear view mirror defoggers switch.

#### ■ Fogging up of the windows

● The windows will easily fog up when the humidity in the vehicle is high. Turning "A/C" switch on will dehumidify the air from the outlets and defog the windshield effectively.

● If you turn "A/C" switch off, the windows may fog up more easily.

● The windows may fog up if the recirculated air mode is used.

#### ■ When driving on dusty roads

Close all windows. If dust thrown up by the vehicle is still drawn into the vehicle after closing the windows, it is recommended that the air intake mode be set to outside air mode and the fan speed to any setting except off.

#### ■ Outside/recirculated air mode

● Setting to the recirculated air mode temporarily is recommended in preventing dirty air from entering the vehicle interior and helping to cool the vehicle when the outside air temperature is high.

● Outside/recirculated air mode may automatically switch depending on the temperature setting or the inside temperature.

#### ■ Operation of the air conditioning system in Eco drive mode

● In Eco drive mode, the air conditioning system is controlled as follows to prioritize fuel efficiency:

- Engine speed and compressor

- operation controlled to restrict heating/cooling capacity
- Fan speed restricted when automatic mode is selected
- To improve air conditioning performance, perform the following operations:
  - Adjust the fan speed
  - Turn off Eco drive mode (→P.351)
  - Turn off Eco air conditioning mode
- When the driving mode is set to Eco driving mode, the Eco air conditioning mode will be turned on automatically. Even in this case, the Eco air conditioning mode can be turned off by pressing the Eco air conditioning mode switch.

■ **When the outside temperature falls to nearly 32°F (0°C)**

The dehumidification function may not operate even when "A/C" switch is pressed.

■ **Ventilation and air conditioning odors**

- To let fresh air in, set the air conditioning system to the outside air mode.
- During use, various odors from inside and outside the vehicle may enter into and accumulate in the air conditioning system. This may then cause odor to be emitted from the vents.
- To reduce potential odors from occurring:
  - It is recommended that the air conditioning system be set to outside air mode prior to turning the vehicle off.
  - The start timing of the blower may be delayed for a short period of time immediately after the air conditioning system is started in automatic mode.
- When parking, the system automatically switches to outside air mode to encourage better air circulation throughout the vehicle, helping to reduce odors that occur when starting the vehicle.

■ **Air conditioning system operations when the engine is stopped due to the Stop & Start system (vehicles with Stop & Start system)**

When the engine is stopped due to Stop & Start system operations, the automatic air conditioning cooling, heating and dehumidification functions turn off and the fan speed is decreased according to the outside temperature etc. or air blowing stops. To stop the air conditioning system from turning off, press the Stop & Start cancel switch and refrain from using the Stop & Start system.

■ **When the windshield is fogged up and the engine is stopped due to the Stop & Start system (vehicles with Stop & Start system)**

Press the windshield defogger switch to restart the engine and defog the windshield.

If the windshield continuously fogs up, press the Stop & Start cancel switch and refrain from using the Stop & Start system.

■ **When an odor comes from the air conditioning system while the engine is stopped due to the Stop & Start system (vehicles with Stop & Start system)**

Press the Stop & Start cancel switch to restart the engine.

■ **Air conditioning filter**

→P.599

■ **Customization**

Some functions can be customized. (Customizable features: →P.697)

**⚠ WARNING****■ To prevent the windshield from fogging up**

Do not use the windshield defogger switch during cool air operation in extremely humid weather. The difference between the temperature of the outside air and that of the windshield can cause the outer surface of the windshield to fog up, blocking your vision.

**■ When the outside rear view mirror defoggers are operating (if equipped)**

Do not touch the rear view mirror surfaces when the outside rear view mirror defoggers are on.

**⚠ NOTICE****■ To prevent battery discharge**

Do not leave the air conditioning system on longer than necessary when the engine is off.

**Using automatic mode**

- 1 Press the "AUTO" switch.

The dehumidification function begins to operate. Air outlets and fan speed are automatically adjusted according to the temperature setting and humidity.

- 2 Adjust the temperature setting.
- 3 To stop the operation, press the "OFF" switch.

If the fan speed setting or air flow modes are operated, the automatic mode indicator goes off. However, automatic mode for functions other than that operated is maintained.

**■ Using automatic mode**

Fan speed is adjusted automatically according to the temperature setting and the ambient conditions.

Therefore, the fan may stop for a while until warm or cool air is ready to flow immediately after the automatic mode switch is pressed.

**Front seat concentrated airflow mode (S-FLOW)**

This function automatically controls the air conditioning airflow so that priority is given to the front seats. When the front passenger seat is not occupied, airflow may switch to only the driver's seat. Unnecessary air conditioning is suppressed, contributing to increased fuel efficiency.

Front seat concentrated airflow mode operates in the following situations.

- No passengers are detected in the rear seats
- The windshield defogger is not operating

While operating,  illuminates.

**■ Manually turning front seat concentrated airflow mode on/off**

In front seat concentrated airflow mode, directing airflow to the front seats only and to all seats can be switched via switch

operation. When the mode has been switched manually, automatic airflow control stops operating.

Press  on the air conditioning operation panel and switch the airflow.

- Indicator illuminated: Airflow to the front seats only
- Indicator off: Airflow to all the seats

#### ■ Operation of automatic airflow control

- In order to maintain a comfortable interior, airflow may be directed to seats without passengers immediately after the engine is started and at other times depending on the outside temperature.
- After the engine is started, if passengers move around inside or enter/exit the vehicle, the system cannot accurately detect the presence of passengers and automatic airflow control will not operate.

#### ■ Operation of manual airflow control

Even if the function is manually switched to directing airflow to only the front seats, when a rear seat is occupied, it may automatically direct airflow to all seats.

#### ■ To return to automatic airflow control

- 1 With the indicator off, turn the engine switch off.
- 2 After 60 minutes or more elapse, turn the engine switch to ON.

### Windshield wiper de-icer (if equipped)

This feature is used to prevent ice from building up on the windshield and wiper blades.

Press the switch to turn the system on/off.

The indicator comes on when the system is on.

The windshield wiper de-icer will automatically turn off after a period of time.

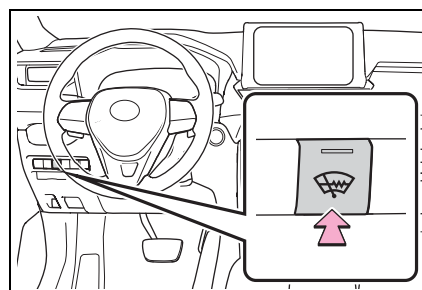

#### ⚠ WARNING

##### ■ To prevent burns

Do not touch the glass at lower part of the windshield or to the side of the front pillars when the windshield wiper deicer is on.

### Air outlet layout and operations

#### ■ Location of air outlets

The air outlets and air volume change according to the selected air flow mode.



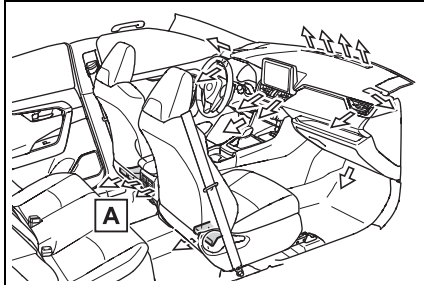

**A** If equipped

■ **Adjusting the air flow direction and opening/closing the air outlets**

► Front

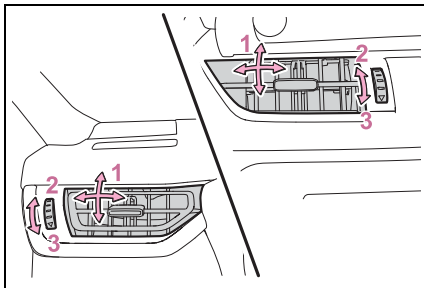

- 1 Direct air flow to the left or right, up or down
- 2 Open the vent\*
- 3 Close the vent\*

\*: If equipped (center air outlets only)

► Rear (if equipped)

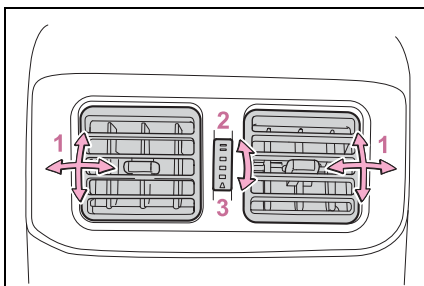

- 1 Direct air flow to the left or right, up or down
- 2 Open the vent
- 3 Close the vent

**⚠ WARNING**

■ **To not interrupt the windshield defogger from operating**

Do not place anything on the instrument panel which may cover the air outlets. Otherwise, air flow may be obstructed, preventing the windshield defoggers from defogging.

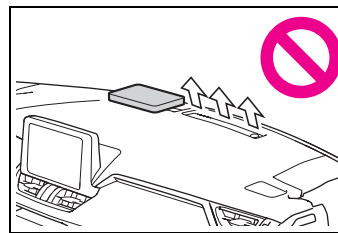

### Heated steering wheel<sup>\*</sup>/seat heaters<sup>\*</sup>/seat ventilators<sup>\*</sup>

<sup>\*</sup>: If equipped

#### ● Heated steering wheel

Warm up the grip of the steering wheel

#### ● Seat heaters

Warm up the seat upholstery

#### ● Seat ventilators

Maintain good ventilation by pulling air through the seat upholstery

### ⚠ WARNING

#### ■ To prevent minor burn injuries

Care should be taken if anyone in the following categories comes in contact with the steering wheel or seats when the heater is on:

- Babies, small children, the elderly, the sick and the physically challenged
- Persons with sensitive skin
- Persons who are fatigued
- Persons who have taken alcohol or drugs that induce sleep (sleeping drugs, cold remedies, etc.)

### ⚠ NOTICE

#### ■ To prevent damage to the seat heaters and seat ventilators

Do not put heavy objects that have an uneven surface on the seat and do not stick sharp objects (needles, nails, etc.) into the seat.

#### ■ To prevent battery discharge

Do not use the functions when the engine is not running.

### Heated steering wheel

Turns the heated steering wheel on/off

The indicator light comes on when the heated steering wheel is operating.

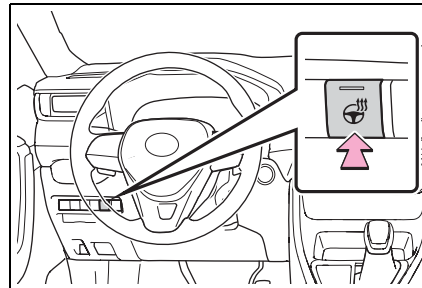

#### ■ Operation condition

The engine switch is in ON.

### Operating the seat heaters

#### ► Front

Turns the seat heaters on/off

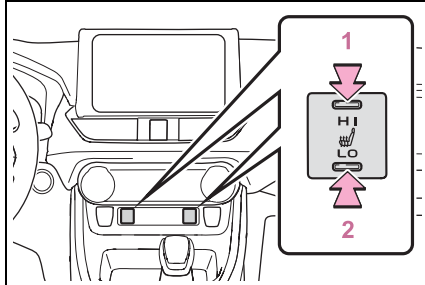

- 1 High temperature
- 2 Low temperature

When the seat heater is on, the indicator illuminates on the seat heater switch.

When not in use, put the switch in the neutral position. The indicator will turn off.

► Rear

Turns the seat heaters on/off

The indicator light comes on when the seat heater is operating.

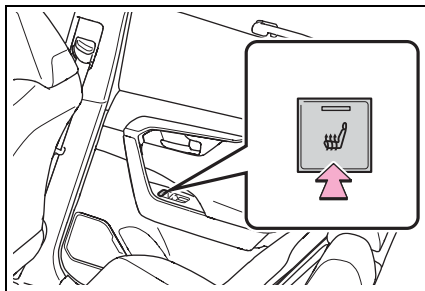

■ Operation condition

The engine switch is in ON.

**! WARNING**

■ To prevent causes of overheating and minor burn injuries

Observe the following precautions when using a seat heater:

- Do not cover the seat with a blanket or cushion when using the seat heater.
- Do not use seat heater more than necessary.

**Seat heaters and ventilators**

Turns the seat heaters and ventilators on/off

Each time the switch is pressed, the operation condition changes as follows.

Hi (3 segments lit) → Mid (2 segments lit) → Lo (1 segment lit) → Off

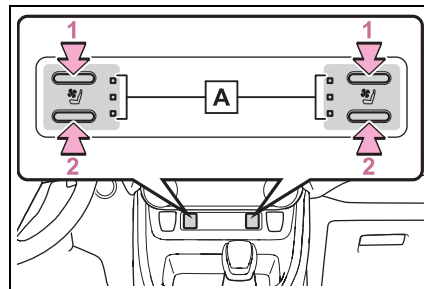

- 1 Turns the seat heater on

The level indicators (yellow) **A** light up during operation.

- 2 Turns the seat ventilator on

The level indicators (green) **A** light up during operation.

■ **Operation condition**

The engine switch is in ON.

■ **Air conditioning system-linked control mode**

When a seat ventilator is set to Hi, the fan speed of the seat ventilator may increase according to the fan speed of the air conditioning system.



**WARNING**

■ **To prevent causes of overheating and minor burn injuries**

Observe the following precautions when using a seat heater:

- Do not cover the seat with a blanket or cushion when using the seat heater.
- Do not use seat heater more than necessary.

Interior lights list

Location of the interior lights

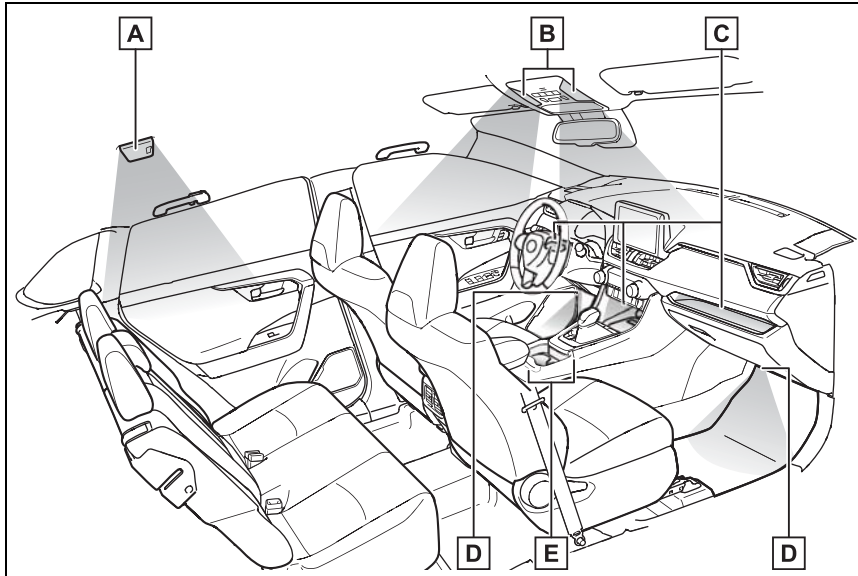

- A** Rear interior light (→P.526)
- B** Front interior lights/personal lights (→P.525, 526)
- C** Open tray lights (if equipped)\*
- D** Footwell lights (if equipped)\*
- E** Front cup holder lights (if equipped)\*

\*: These lights turn on when a door is unlocked.  
 When the shift lever is in a position other than P, the brightness of these lights will reduce intensity.

Operating interior lights

- **Front interior lights**  
 Turns the lights on/off

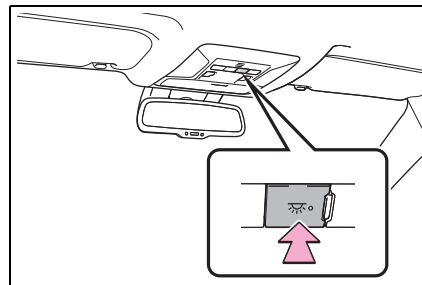

Turns the switch to the door position (door linked)

When a door is opened while the door position is on, the lights turn on.

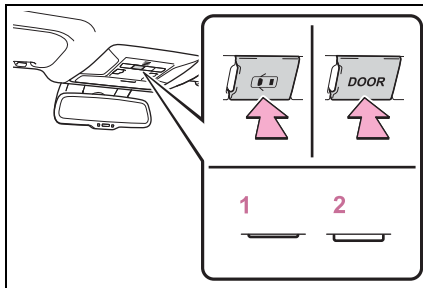

- 1 Turns the door position on
- 2 Turns the lights off

■ Rear interior light

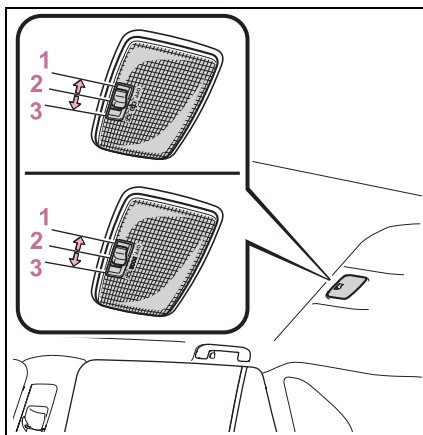

- 1 Turns the light off
  - 2 Turns the door position on
- When a door is opened while the door position is on, the light turns on.
- 3 Turns the light on

**Operating personal lights**

Turns the lights on/off

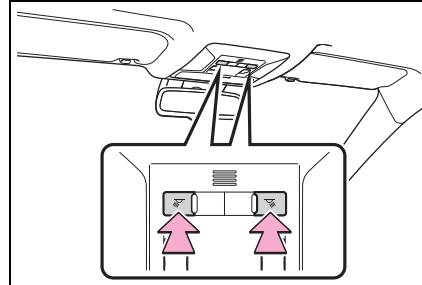

■ Illuminated entry system (vehicles with smart key system)

The lights automatically turn on/off according to the engine switch mode, the presence of the electronic key, whether the doors are locked/unlocked, and whether the doors are opened/closed.

■ To prevent the battery from being discharged

If the interior lights remain on when the engine switch is turned to OFF, the lights will go off automatically after 20 minutes.

■ The interior lights will turn on automatically when

If any of the SRS airbags deploy (inflate) or in the event of a strong rear impact, the interior lights will turn on automatically.

The interior lights will turn off automatically after approximately 20 minutes.

The interior lights can be turned off manually. However, in order to help prevent further collisions, it is recommended that they be left on until safety can be ensured.

(The interior lights may not turn on automatically depending on the force of the impact and conditions of the collision.)

■ Customization

Setting (e.g. the time elapsed before the lights turn off) can be changed. (Customizable features: →P.698)



NOTICE

■ **To prevent battery discharge**

Do not leave the lights on longer than necessary when the engine is not running.

List of storage features

Location of the storage features

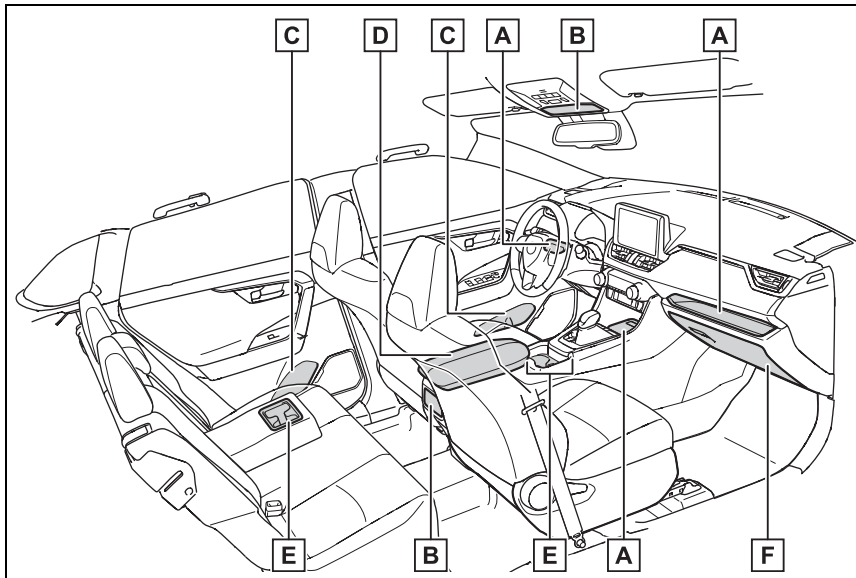

- A** Open tray (→P.531)
- B** Auxiliary boxes (→P.530)
- C** Bottle holders (→P.530)
- D** Console box (→P.529)
- E** Cup holders (→P.529)
- F** Glove box (→P.528)

**⚠ WARNING**

**■ Items that should not be left in the vehicle**

Do not leave glasses, lighters or spray cans in the storage spaces, as this may cause the following when cabin temperature becomes high:

- Glasses may be deformed by heat or cracked if they come into contact with other stored items.

- Lighters or spray cans may explode. If they come into contact with other stored items, the lighter may catch fire or the spray can may release gas, causing a fire hazard.

**Glove box**

Pull up the lever to open the glove box.



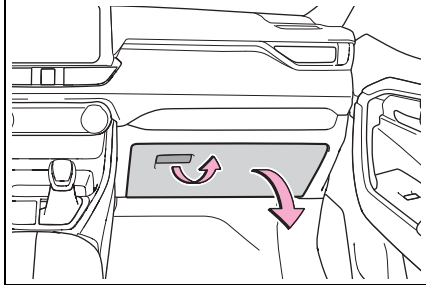

**⚠ WARNING**

■ **Caution while driving**  
 Keep the glove box closed. In the event of sudden braking or sudden swerving, an accident may occur due to an occupant being struck by the open glove box or the items stored inside.

**Console box**

Lift the lid while pushing the button to release the lock.

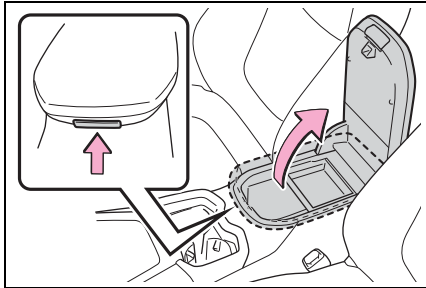

■ **Console box tray (if equipped)**  
 The tray can be removed and stored in the bottom of the console box.

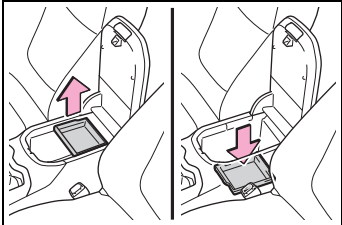

**⚠ WARNING**

■ **Caution while driving**  
 Keep the console box closed. Injuries may result in the event of an accident or sudden braking.

**Cup holders**

► Front

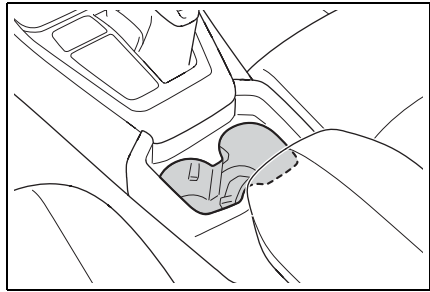

► Rear

Pull the armrest down.

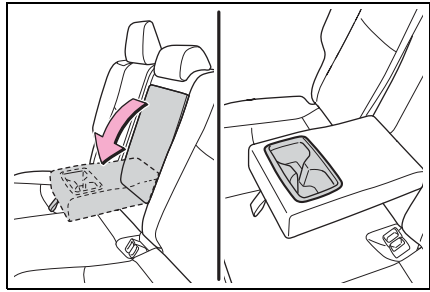

**⚠ WARNING**

**■ Items unsuitable for the cup holders**

Do not place anything other than cups or beverage cans in the cup holders. Inappropriate items must not be stored in the cup holders even if the lid is closed. Other items may be thrown out of the holders in the event of an accident or sudden braking and cause injury. If possible, cover hot drinks to prevent burns.

**⚠ WARNING**

**■ Items unsuitable for the bottle holders**

Do not place anything other than a bottle in the bottle holders. Other items may be thrown out of the holders in the event of an accident or sudden braking and cause injury.

**⚠ NOTICE**

**■ Items that should be not stowed in the bottle holders**

Do not place open bottles or glass and paper cups containing liquid in the bottle holders. The contents may spill and glasses may break.

**Bottle holders**

► Front

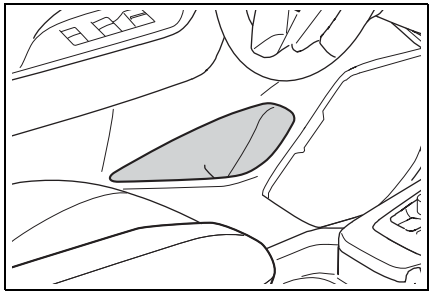

► Rear

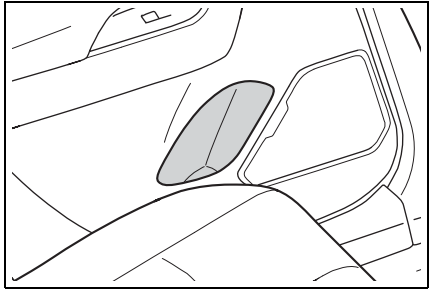

- Bottle holders**
- When storing a bottle, close the cap.
  - The bottle may not be stored depending on its size or shape.

**Auxiliary boxes**

► Type A  
Push the lid.

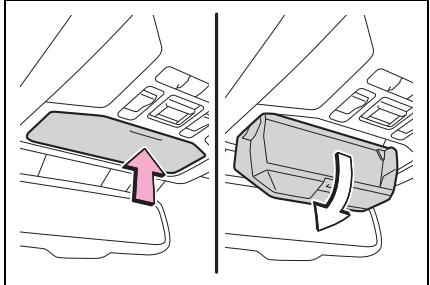

► Type B (if equipped)

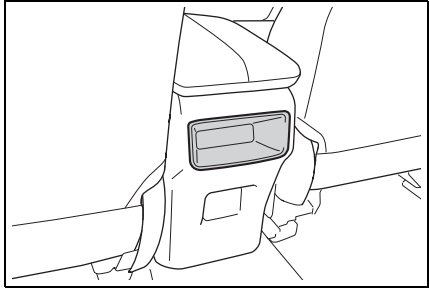

**⚠ WARNING**

■ **Caution while driving**  
Do not leave the auxiliary box (type A) open while driving. Injuries may result in the event of an accident or sudden braking.

■ **Items unsuitable for storing (type A)**  
Do not store items heavier than 0.4 lb. (0.2 kg). Doing so may cause the auxiliary box to open and the items inside may fall out, resulting in an accident.

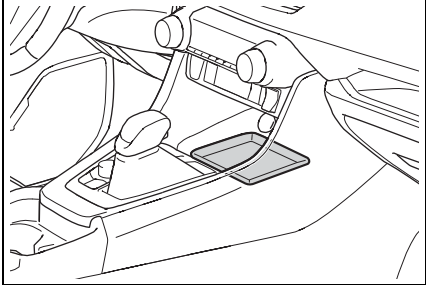

**Open tray**

► Driver's side

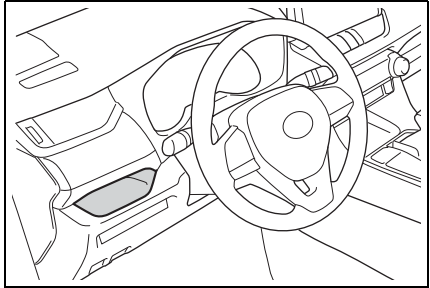

► Front passenger's side

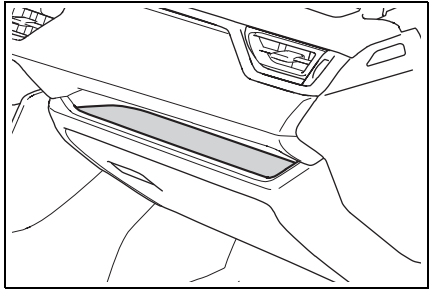

► Front of console

Vehicles with wireless charger:  
→P.540

**⚠ WARNING**

■ **Items unsuitable for the open tray**  
Observe the following precautions when putting items in the open tray. Failure to do so may cause items to be thrown out of the tray in the event of sudden braking or steering. In these cases, the items may interfere with pedal operation or cause driver distraction, resulting in an accident.

- Do not store items in the tray that can easily shift or roll out.
- Do not stack items in the tray higher than the tray's edge.
- Do not put items in the tray that may protrude over the tray's edge.

Luggage compartment features

**Cargo hooks**

Raise the hook to use.

The cargo hooks are provided for securing loose items.

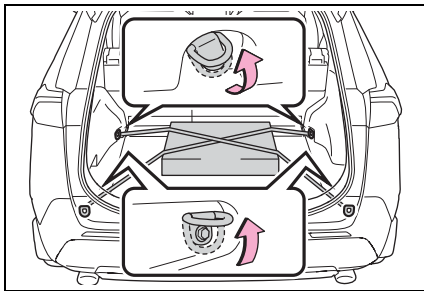

**⚠ WARNING**

■ **When cargo hooks are not in use**

To avoid injury, always return the hooks to their stowed positions when not in use.

**Deck board**

■ **Flipping the deck board upside down**

The deck board can be flipped upside down (resin side up) depending on the situation.

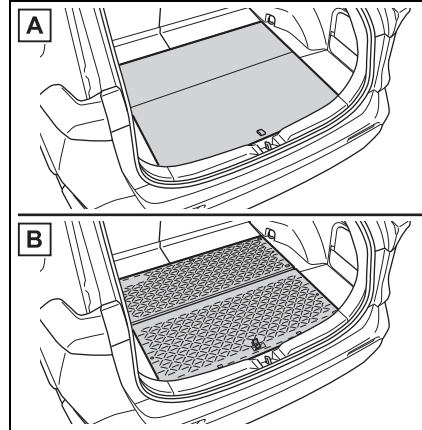

**A** Original position

**B** Underside (resin side)

■ **Changing the deck board positions**

Height of the deck board can be changed by setting the deck board under the floor.

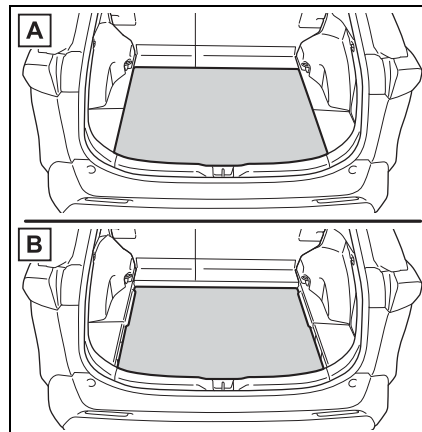

**A** Upper

**B** Lower

- 1 Pull up the tab to raise the deck board and move it toward you to remove.

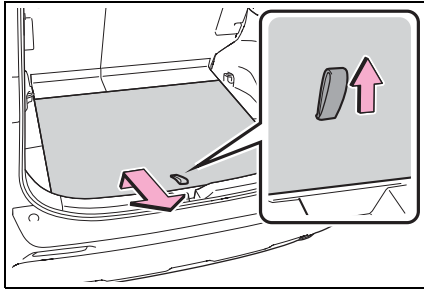

- 2 Place the deck board through the groove and move forward.

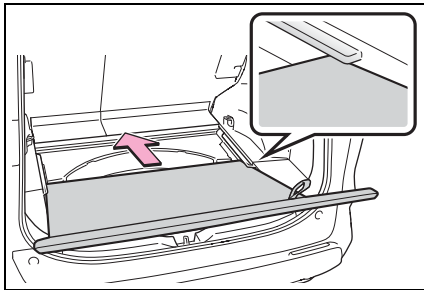

■ **Setting the deck board upright**

When taking out the tools, the deck board can be set upright.

When the back surface (resin surface) of the deck board is facing up, flip it back to the original position.

- 1 Pull up the tab to raise the deck board and fold it forward.

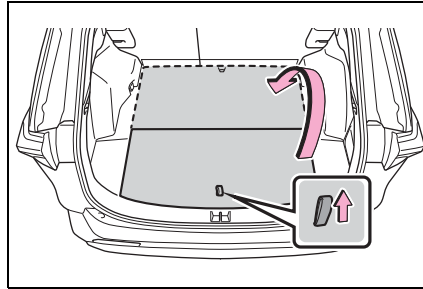

- 2 Place the edge **A** into the groove, and with the deck board in a standing state, put the edge **B** into the holes.

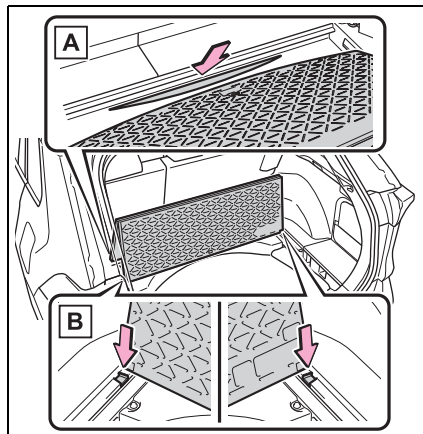

**⚠ WARNING**

■ **When operating the deck board**

Do not place anything on the deck board when operating the board. Otherwise, your fingers may be caught or an accident may result causing injuries.

**⚠ WARNING**

**■ Caution while driving**

Keep the deck board closed.  
In the event of sudden braking, an accident may occur due to an occupant being struck by the deck board or the items stored under the deck board.

**Side auxiliary box**

▶ Type A

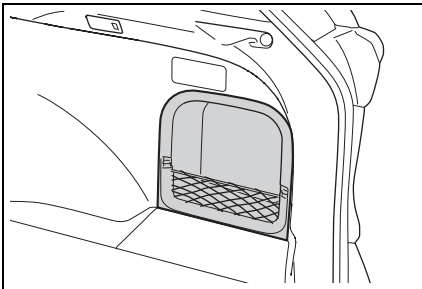

▶ Type B

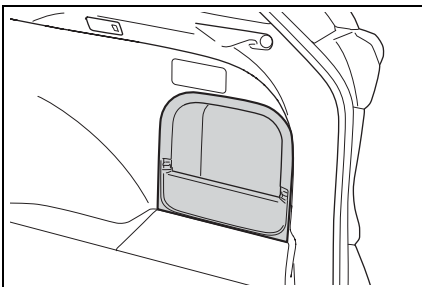

**■ Removing the partition plate**

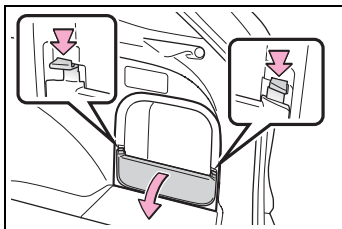

Disengage the claws

**Luggage cover (if equipped)**

**■ Installing the luggage cover**

- 1 Compress the both ends of the luggage cover and insert into the recess to install.

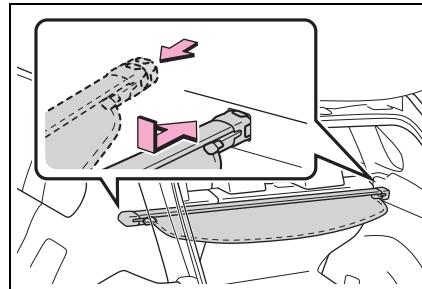

- 2 Pull out the luggage cover and hook it onto the anchors.

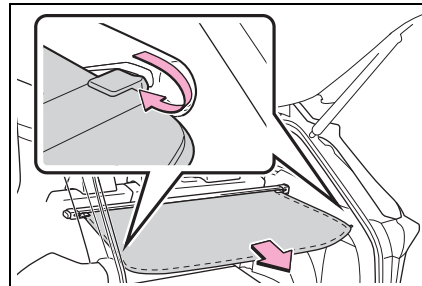

■ **Removing the luggage cover**

- 1 Release the cover from the left and right anchors and allow it to retract.

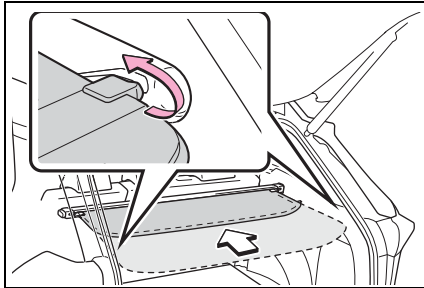

- 2 Compress the end of the luggage cover and lift the luggage cover up.

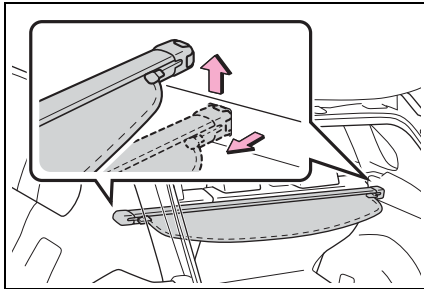

■ **Stowing the luggage cover**

- 1 Open the rear deck board and remove the side deck covers.

When the back surface (resin surface) of the deck board is facing up,

remove the deck board.

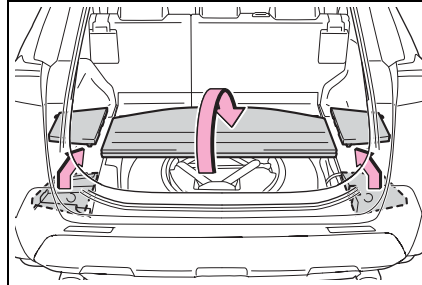

- 2 Place the both ends of the luggage cover into the holder.

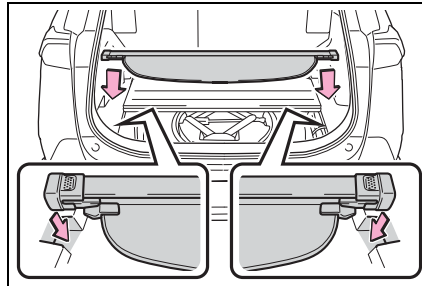

**⚠ WARNING**

■ **Luggage cover**

- When installing/stowing the luggage cover, make sure that the luggage cover is securely installed/stowed. Failure to do so may result in serious injury in the event of sudden braking or a collision.
- Do not place anything on the luggage cover. In the event of sudden braking or turning, the item may go flying and strike an occupant. This could lead to an unexpected accident, resulting in death or serious injury.
- Do not allow children to climb on the luggage cover. Climbing on the luggage cover could result in damage to the luggage cover, possibly causing death or serious injury to the child.



NOTICE

■ **To prevent damage to the luggage cover**

Do not place anything on top of the luggage cover. When rolling up the luggage cover, objects may be caught in the cover, damaging the cover and generating noise.



Other interior features

Sun visors

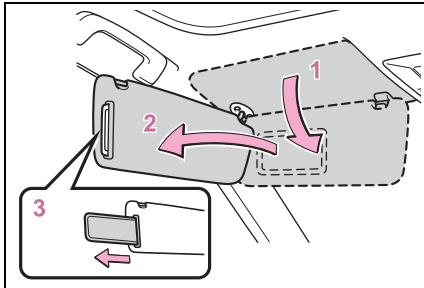

- 1 To set the visor in the forward position, flip it down.
- 2 To set the visor in the side position, flip down, unhook, and swing it to the side.
- 3 To use the side extender (if equipped), place the visor in the side position, then slide it backward.

Vanity mirrors

Slide the cover to open.

The light turns on when the cover is opened.

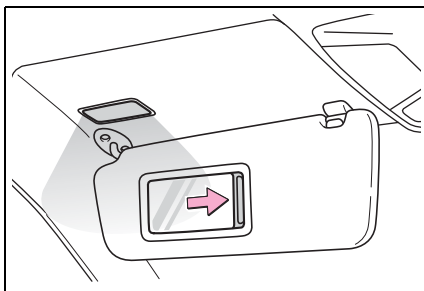

■ Automatic light off to prevent battery discharge

If the vanity lights remain on when

the engine switch is turned to OFF, the lights will go off automatically after 20 minutes.

⚠ NOTICE

■ To prevent battery discharge

Do not leave the vanity lights on for extended periods while the engine is off.

Power outlet

The power outlet can be used for the following components:

12 V: Accessories that run on less than 10 A.

120 VAC: Accessories that use less than 100 W.

■ 12 V

► Front

Open the lid.

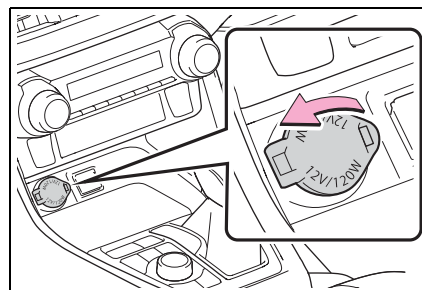

► Console box (if equipped)

Open the console box and open the lid.

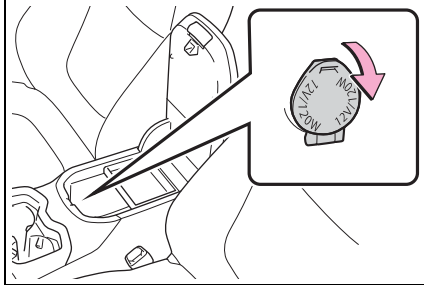

- ▶ Rear (if equipped)  
Open the lid.

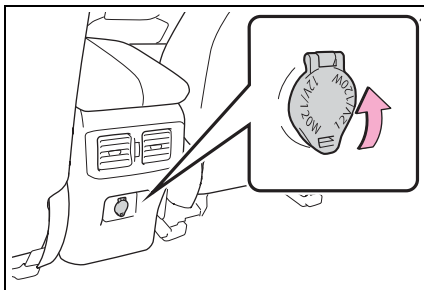

- ▶ Luggage compartment (if equipped)  
Open the lid.

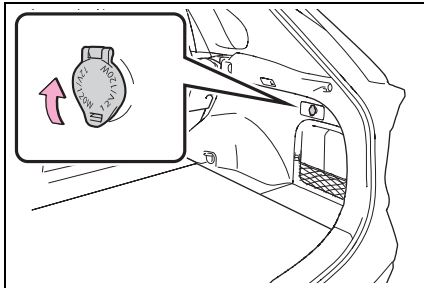

- 120 VAC (if equipped)  
Open the lid.

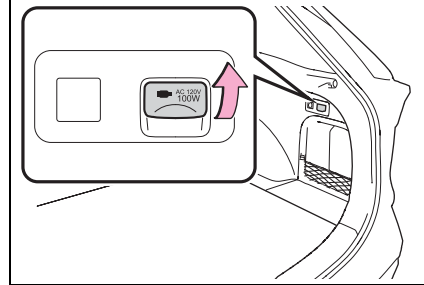

■ **The power outlet can be used when**

- ▶ 12 V  
The engine switch is in ACC or ON.
- ▶ 120 VAC  
The engine switch is in ON.

■ **When turning the engine switch off**

Disconnect electrical devices with charging functions, such as mobile battery packs.  
If such devices are left connected, the engine switch may not be turned off normally.

⚠ NOTICE

■ **To avoid damaging the power outlet**

Close the power outlet lid when the power outlet is not in use. Foreign objects or liquids that enter the power outlet may cause a short circuit.

■ **To prevent the fuse from being blown**

- 12 V  
Do not use an accessory that uses more than 12 V 10 A.

 **NOTICE**

- **120 VAC**  
Do not use a 120 VAC appliance that requires more than 100 W. If a 120 VAC appliance that consumes more than 100 W is used, the protection circuit will cut the power supply.
- **To prevent battery discharge**  
Do not use the power outlet longer than necessary when the engine is not running.
- **Appliances that may not operate properly (120 VAC)**  
The following 120 VAC appliances may not operate properly even if their power consumption is under 100 W.
  - Appliances with high initial peak wattage
  - Measuring devices that process precise data
  - Other appliances that require an extremely stable power supply

**USB charging ports (if equipped)**

The USB charging ports are used to supply 2.1 A of electricity at 5 V to external devices. The USB charging ports are for charging only. They are not designed for data transfer or other purposes. Depending on the external device, it may not charge properly. Refer to the manual included with the device before using a USB charging port.

■ **Using the USB charging ports**

▶ **Console box**

Open the console box and open the lid.

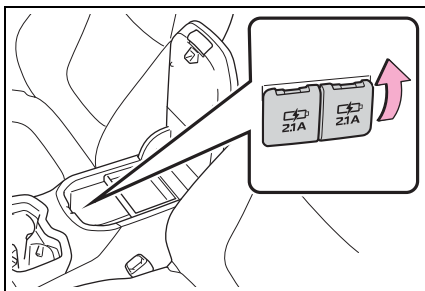

▶ **Rear**

Open the lid.

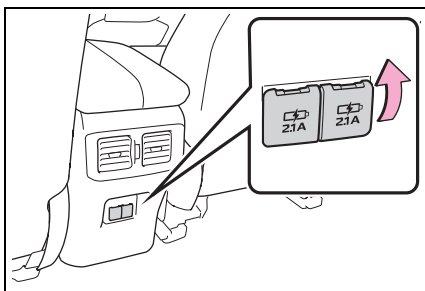

■ **The USB charging ports can be used when**

The engine switch is in ACC or ON.

■ **Situations in which the USB charging ports may not operate correctly**

- If a device which consumes more than 2.1 A at 5 V is connected
- If a device designed to communicate with a personal computer, such as a USB memory device, is connected
- If the connected external device is turned off (depending on device)
- If the temperature inside the vehicle is high, such as after the vehi-

cle has been parked in the sun

#### ■ About connected external devices

Depending on the connected external device, charging may occasionally be suspended and then start again. This is not a malfunction.



#### NOTICE

##### ■ To prevent damage to the USB charging ports

- Do not insert foreign objects into the ports.
- Do not spill water or other liquids into the ports.
- When the USB charging ports are not in use, close the lids. If a foreign object or liquid enters a port may cause a short circuit.
- Do not apply excessive force to or impact the USB charging ports.
- Do not disassemble or modify the USB charging ports.

##### ■ To prevent damage to external devices

- Do not leave external devices in the vehicle. The temperature inside the vehicle may become high, resulting in damage to an external device.
- Do not push down on or apply unnecessary force to an external device or the cable of an external device while it is connected.

##### ■ To prevent battery discharge

Do not use the USB charging ports for a long period of time when the engine is off.

#### Wireless charger (if equipped)

A portable device can be charged by just placing Qi standard wireless charge compatible portable devices according to the Wireless Power Consortium, such as smartphones and mobile batteries, etc., on the charge area.

This function cannot be used with portable devices that are larger than the charging area. Also, depending on the portable device, it may not operate as normal. Please read the operation manual for portable devices to be used.

#### ■ The “Qi” symbol

The “Qi” symbol is a trademark of the Wireless Power Consortium.



■ Name for all parts

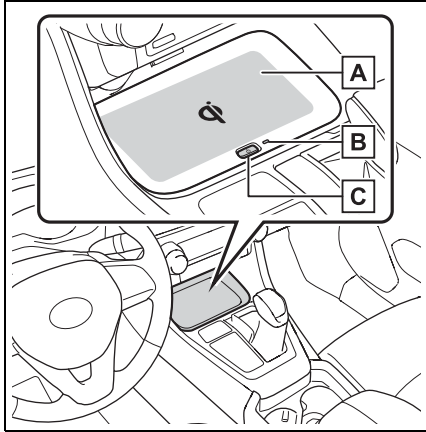

- A Charge area
- B Operation indicator light
- C Power supply switch

■ Using the wireless charger

- 1 Press the power supply switch of the wireless charger.

Switches on and off with each press of the power supply switch.

When turned on, the operation indicator light (green) comes on.

Even with the engine off, the on/off state of the power supply switch is memorized.

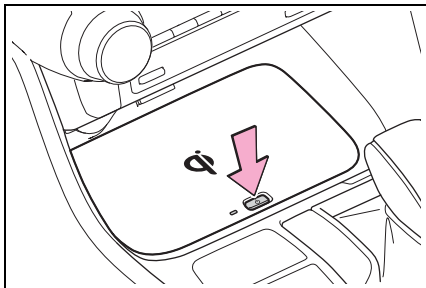

- 2 Place the charging side of the portable device down.

When charging, the operation indi-

cator light (orange) comes on.

If charging is not occurring, try placing the portable device as close to the center of the charging area as possible.

When charging is complete, the operation indicator light (green) comes on.

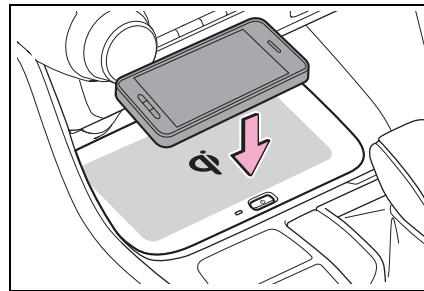

■ Recharging function

- When charging is complete and after a fixed time in the charge suspension state, charging restarts.
- When the portable device is moved, charging is stopped for a moment and then it restarts.

■ Lighting conditions of operation indicator light

Operation indicator light	Conditions
Turning off	When the Wireless charger power supply is off
Green (comes on)	On Standby (charging possible state)
	When charging is complete*

Operation indicator light	Conditions
Orange (comes on)	When placing the portable device on the charging area (detecting the portable device)
	Charging

\*: Depending on the portable device, there are cases where the operation indicator light will continue being lit up orange even after the charging is complete.

- When the operation indicator light flashes

When an error occurs, the operation indicator light flashes an orange color.

Handle the error based on the following tables.

- Flashing repeatedly once every second (Orange)

Suspected causes	Handling method
Vehicle to charger communication failure.	Contact your Toyota dealer.

- Repeatedly flashes 3 times continuously (Orange)

Suspected causes	Handling method
A foreign substance is between the portable device and charge area.	Remove the foreign substance from between portable device and the charge area.
The portable device is out of sync due to the device being shifted from the center of the charge area.	Place the portable device near the center of the charge area.

- Repeatedly flashes 4 times continuously (Orange)

Suspected causes	Handling method
Temperature rising within the wireless charger.	Stop charging at once and start charging again after for a while.

■ **The wireless charger can be operated when**

The engine switch is in ACC or ON.

■ **Usable portable devices**

Qi standard wireless charge standard can be used on compatible devices.

However, not all Qi standard devices and compatibility are guaranteed.

Starting with mobile phones and smartphones, it is aimed for low power electrically supplied portable devices of no more than 5W.

■ **When covers and accessories are attached to portable devices**

Do not charge in situations where cover and accessories not able to handle Qi are attached to the portable device. Depending on the type of cover and accessory, it may not be possible to charge. When charging is not performed even with the portable device placed on the charge area, remove the cover and accessories.

■ **While charging, noise enters the AM radio**

Turn off the wireless charger and confirm that the noise has decreased. If the noise decreases, continuously pushing the power supply switch of the wireless charger for 2 seconds, the frequency of the charger can be changed and the noise can be reduced. Also, on that occasion, the operation indicator light will flash orange 2 times.

■ **Certification for the wireless charger**

<p>FCC Provided Information:                  This equipment has been tested and found to comply with Part 18 of the FCC Rules. These limits are designed to provide reasonable protection against harmful interference in a residential installation. Any changes or modifications not expressly approved by the party responsible for compliance could void the user's authority to operate this equipment.                  This device complies with Part 18 of the FCC Rules. Operation is subject to the following two conditions:                  (1) This device may not cause harmful interference, and (2) this device must accept any interference received, including interference that may cause undesired operation.</p>	
<p><u>Declaration of Conformity</u></p>	
Trade Name:	Panasonic
Model Numbers:	AT1701 contains CA-QS03J1AJ
Responsible Party:	Panasonic Corporation of North America Two Riverfront Plaza, Newark, NJ 07102-5490
Support Contact:	<a href="http://shop.panasonic.com/support/">http://shop.panasonic.com/support/</a>

■ **Important points of the wireless charger**

- If the electronic key cannot be detected within the vehicle interior, charging cannot be done. When the door is opened and closed, charging may be temporarily suspended.
- When charging, the wireless charging device and portable device will get warmer, however this is not a malfunction. When a portable device gets warm while charging, charging may stop due to the protection function on the portable device side. In this case, when the temperature of the portable device drops significantly, charge again.

■ **Operation sounds**

When the power supply is turned on, while searching for the portable device a sound will be produced, however this is not a malfunction.



PRODUCT SAFETY AND COMPLIANCE DEPARTMENT . PANASONIC CORPORATION OF NORTH AMERICA . TWO RIVERFRONT PLAZA, 8<sup>TH</sup> FLOOR, NEWARK, NJ 07102-5480

## FCC Declaration of Conformity

### Summary

Product Name	In-Vehicle Wireless Charger	
Model Number	AT1701	
Brand Name	Panasonic	
Size and Mass	<ul style="list-style-type: none"> <li>• 245mm (w), 136mm (l) and 48mm (h) and mass is 515grams</li> </ul>	
Purpose Updated DoC	Added similarity variant model / AT1701 contains CA-QS03J1AJ	
Compliance Information	<ul style="list-style-type: none"> <li>• 47 CFR, FCC Part 18, Subpart C for ISM Equipment FCC' s KDB 680106 D01 RF Exposure Wireless Charging Apps v02</li> <li>• Industry Canada RSS-216, Issue 1, dated August 2014 For Wireless Power Transfer Devices (Wireless Chargers)</li> </ul>	
Responsible Applicant	Panasonic Corporation Automotive & Industrial Systems Company Automotive Infotainment Systems Business Division 4261, Ikonobe-cho, Tsuzuki-ku, Yokohama-shi, 224-8520, Japan	
Responsible Factories	<ul style="list-style-type: none"> <li>• Panasonic Corporation, Automotive &amp; Industrial Systems Company Automotive Infotainment / Systems Business Division Global Manufacturing Innovation Center, Matsumoto Factory 5652 Sasaga, Matsumoto city, Nagano 399-8730, Japan</li> <li>• Panasonic Automotive Systems Czech, s.r.o. U Panasonicu 266, 530 06 Pardubice-Stare Covice, Czech Republic</li> <li>• Panasonic Automotive Systems Asia Pacific (Thailand) Co.,Ltd. 101 Moo 2 Teparak Road, T.Bangsaothong Ging A.Bangsaothong Samutprakarn 10540 Thailand</li> <li>• Panasonic Automotive Systems Dalian Co., Ltd. No.300, HongGang Road, GanJingZi District, Dalian, Liaoning Province, 116033 China</li> </ul>	
Responsible Sales Company	Panasonic Consumer Electronics Company Division of Panasonic Corporation of North America Two Riverfront Plaza, Newark, NJ 07102-5490 General Contact: <a href="http://shop.panasonic.com/support">http://shop.panasonic.com/support</a>	
Special Conditions For Compliance	In-Vehicle Wireless Charger will be installed and used exclusively within transportation vehicle and as such, it is exempt from the following requirements: (1) Part 15 digital device technical rules in accordance with §15.103(a); and (2) §15.105(b) full text information to user to appear in User Manual in accordance with §18.213.	
EMI Test Report	TCB	UL Japan
	Test Report	10120384-R2
	Model Tested	AT1701 contains CA-QS03J1AJ
	Date Issued	12/14/2015
	Methodology	FCC-OET MP-4

PRODUCT SAFETY AND COMPLIANCE DEPARTMENT . PANASONIC CORPORATION OF NORTH AMERICA . TWO RIVERFRONT PLAZA, 8<sup>TH</sup> FLOOR, NEWARK, NJ 07102-5480





PRODUCT SAFETY AND COMPLIANCE DEPARTMENT . PANASONIC CORPORATION OF NORTH AMERICA . TWO RIVERFRONT PLAZA, 8<sup>TH</sup> FLOOR, NEWARK, NJ 07102-6480

**FCC Declaration of Conformity**  
**Summary**

RF Exposure Evaluation	TCB	UL Japan
	MPE Test Report	10197157S-E-R1
	Model Tested	AT1701 contains CA-QS03J1AJ
	Date Issued	12/14/2015
	Methodology	KDB 680106 D01 RF Exposure Wireless Charging Apps v02
Importation	The subject In-Vehicle Wireless Charger can be imported on behalf of Panasonic affiliated sales companies by PNA's Logistics Import Customs, or their authored brokers, by electrically filing FCC Form 740 while declaring Box 2 with no reference to any FCC ID.	

This DoC is granted for the subject In-Vehicle Wireless Charger on the basis of the manufacturer's attested compliance with the above described conditions and in accordance with FCC Part 18 and FCC's KDB 0680106 D01 RF Exposure Wireless Charging Apps v02.

Certificate Number: DoC 2014-008C  
Applicant Ref No.: PAS-16-F001

*Richard Mullen*  
Issued by: Richard Mullen  
Issue Date: January 14, 2016

PRODUCT SAFETY AND COMPLIANCE DEPARTMENT . PANASONIC CORPORATION OF NORTH AMERICA . TWO RIVERFRONT PLAZA, 8<sup>TH</sup> FLOOR, NEWARK, NJ 07102-6480

**⚠ WARNING****■ Caution while driving**

When charging a portable device, for safety reasons, the driver should not operate the main part of the portable device while driving.

**■ Caution regarding interference with electronic devices**

People with implantable cardiac pacemakers, cardiac resynchronization therapy-pacemakers or implantable cardioverter defibrillators, as well as any other electrical medical device, should consult their physician about the usage of the wireless charger. The operations of the wireless charger may have an affect on medical devices.

**■ To prevent damage or burns**

Observe the following precautions.

Failure to do so may result in a possibility of equipment failure and damage, catch fire, burns due to overheat.

- Do not insert any metallic objects between the charging area and the portable device while charging
- Do not attach stickers, metallic objects, etc., to the charger area or portable device
- Do not cover with cloth, etc., and charge
- Do not charge portable devices other than designated
- Do not attempt to dismantle for disassembly or modifications
- Do not hit or apply a strong force

**⚠ NOTICE****■ Conditions in which the function may not operate correctly**

In the following conditions, it may not operate correctly

- The portable device is fully charged
- There is foreign matter between the charge area and portable device
- The temperature of the portable device gets higher from charging
- The charging surface of the portable device is facing up
- The placement of the portable device is out of alignment with the charge area
- Near a TV tower, electric power plant, gas station, radio station, large display, airport or other facility that generates strong radio waves or electrical noise
- When the electronic key is in contact with, or is covered by the following metallic objects
  - Cards to which aluminum foil is attached
  - Cigarette boxes that have aluminum foil inside
  - Metallic wallets or bags
  - Coins
  - Hand warmers made of metal
  - Media such as CDs and DVDs

 **NOTICE**

- When other wireless keys (that emit radio waves) are being used nearby

In addition, excluding the above-mentioned, when the charger does not perform normally or the operation display lamp is flashing continuously, it is considered that the wireless charger is malfunctioning. Contact authorized Toyota dealer.

- **To prevent failure or damage to data**
- Do not bring magnetic cards, such as credit cards, or magnetic recording media, etc., close to the charger while charging, otherwise, data may disappear under the influence of magnetism. Also, do not bring precision instruments such as wrist watches, etc., close to the charger, as such objects may break.
- Do not leave portable devices in the cabin. The temperature inside the cabin may become high, when under the sun, and cause damage to the device.

- **To prevent battery discharge**

When the engine is stopped, do not use the wireless charger for a long time.

**Armrest**

Fold down the armrest for use.

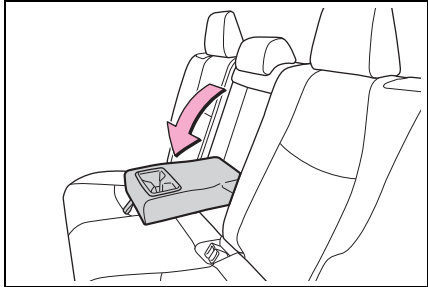

 **NOTICE**

- **To prevent damage to the armrest**

Do not apply too much load on the armrest.

**Assist grips**

An assist grip installed on the ceiling can be used to support your body while sitting on the seat.

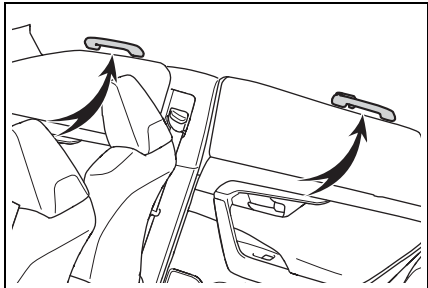

 **WARNING**

- **Assist grips**

Do not use the assist grip when getting in or out of the vehicle or rising from your seat.

 **NOTICE**

■ **To prevent damage to the assist grip**

Do not hang any heavy object or put a heavy load on the assist grip.

**Coat hooks**

The coat hooks are provided with the rear assist grips.

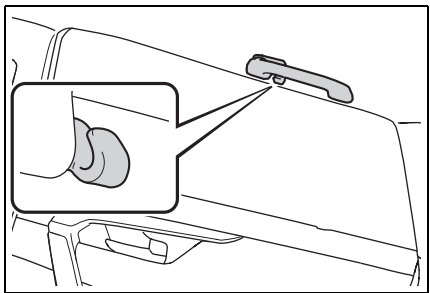

 **WARNING**

■ **Items that must not be hanged on the hook**

Do not hang coat hangers or other hard or sharp objects on the hook. If the SRS curtain shield airbags deploy, these items may become projectiles, causing death or serious injury.

**Garage door opener\***

\*: If equipped

**The garage door opener can be programmed using the HomeLink® to operate garage doors, gates, entry doors, door locks, home lighting systems, security systems, and other devices.**

**System components**

The HomeLink® wireless control system in your vehicle has 3 buttons which can be programmed to operate 3 different devices. Refer to the programming methods on the following pages to determine the method which is appropriate for the device.

- ▶ Vehicles with auto anti-glare inside rear view mirror

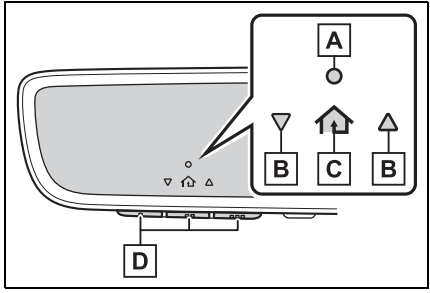

- A** HomeLink® indicator light
  - B** Garage door operation indicators
  - C** HomeLink® icon
- Illuminates while HomeLink® is

operating.

**D** Buttons

- ▶ Vehicles with Digital Rear-view Mirror

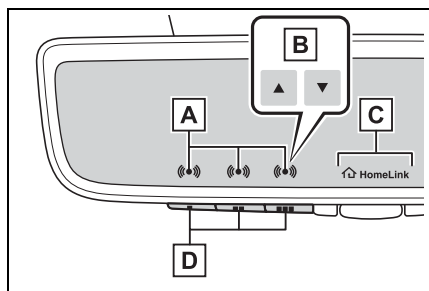

**A** HomeLink® indicator light

Illuminates above each button selected.

**B** Garage door operation indi-

■ **Certification for the garage door opener**

- ▶ For vehicles sold in the U.S. mainland, Hawaii, Guam, Saipan, American Samoa and Puerto Rico

This device complies with FCC rules part 15 and Innovation, Science, and Economic Development Canada RSS-210. Operation is subject to the following two conditions: (1) This device may not cause harmful interference, and (2) This device must accept any interference that may be received including interference that may cause undesired operation. **WARNING:** The transmitter has been tested and complies with FCC and ISCED rules. Changes or modifications not expressly approved by the party responsible for compliance could void the user's authority to operate the device.

This equipment complies with FCC and ISCED radiation exposure limits set forth for an uncontrolled environment. End Users must follow the specific operating instructions for satisfying RF exposure compliance. This transmitter must be at least 20 cm from the user and must not be co-located or operating in conjunction with any other antenna or transmitter.

cators

**C** HomeLink® logo

Appears while HomeLink® is operating.

When the menu button (→P.145) is pressed, the logo disappears even while the HomeLink® is operating.

**D** Buttons

■ **Codes stored in the Home-Link® memory**

- The registered codes are not erased even if the battery cable is disconnected.
- If learning failed when registering a different code to a HomeLink® button that already has a code registered to it, the already registered code will not be erased.

► For vehicles sold in Canada

This device complies with FCC rules part 15 and Innovation, Science, and Economic Development Canada RSS-210. Operation is subject to the following two conditions: (1) This device may not cause harmful interference, and (2) This device must accept any interference that may be received including interference that may cause undesired operation. **WARNING:** The transmitter has been tested and complies with FCC and ISDE rules. Changes or modifications not expressly approved by the party responsible for compliance could void the user's authority to operate the device.

This equipment complies with FCC and ISDE radiation exposure limits set forth for an uncontrolled environment. End Users must follow the specific operating instructions for satisfying RF exposure compliance. This transmitter must be at least 20 cm from the user and must not be co-located or operating in conjunction with any other antenna or transmitter.

Cet appareil est conforme aux règlements de la FCC, section 15, et au CNR-210 d'Innovation, Sciences et Développement économique Canada. Le fonctionnement est assujéti aux deux conditions suivantes : (1) cet appareil ne doit pas causer d'interférences nuisibles et (2) cet appareil doit accepter toute interférence reçue, y compris celle qui pourrait entraîner un dysfonctionnement. **MISE EN GARDE :** L'émetteur a subi des tests et est conforme aux règlements de la FCC et d'ISDE. Les changements ou modifications non approuvés explicitement par la partie responsable de la conformité pourraient rendre caduque l'autorisation de l'utilisateur de se servir du dispositif.

Cet appareil est conforme aux limites d'exposition aux radiations de la FCC et d'ISDE établies pour un environnement non contrôlé. Les utilisateurs finaux doivent respecter les instructions d'utilisation spécifiques pour satisfaire aux exigences de conformité aux expositions de RF. L'émetteur doit se trouver à 20 cm au minimum de l'utilisateur et ne doit pas être situé au même endroit que tout autre émetteur ou antenne ni fonctionner avec un autre émetteur ou antenne.

■ **When support is necessary**

Visit on the web at [www.home-link.com/toyota](http://www.home-link.com/toyota) or call 1-800-355-3515.

 **WARNING**

■ **When programming a garage door or other remote control device**

The garage door or other device may operate, so ensure people and objects are out of danger to prevent potential harm.

■ **Conforming to federal safety standards**

Do not use the HomeLink® compatible transceiver with any garage door opener or device that lacks safety stop and reverse features as required by federal safety standards.

This includes any garage door that cannot detect an interfering object. A door or device without these features increases the risk of death or serious injury.

■ **When operating or programming HomeLink®**

Never allow a child to operate or play with the HomeLink® buttons.

**Programming HomeLink®**

■ **Before programming HomeLink®**

- During programming, it is possible that garage doors, gates, or other devices may operate. For this reason, make sure that people and objects are clear of the garage door or other devices to prevent injury or other potential harm.
- It is recommended that a new battery be placed in the remote control transmitter for successful programming.

- Garage door opener motors manufactured after 1995 may be equipped with rolling code protection. If this is the case, you may need a stepladder or other sturdy, safe device to reach the “Learn” or “Smart” button on the garage door opener motor.

### ■ Programming HomeLink®

Steps 1 through 3 must be performed within 60 seconds, otherwise the HomeLink® indicator light will stop flashing and programming will not be successfully completed.

- 1 Press and release the HomeLink® button you want to program and check that the HomeLink® indicator light flashes (orange).
- 2 Point the remote control transmitter for the device at the rear view mirror, 1 to 3 in. (25 to 75 mm) from the HomeLink® buttons.

Keep the HomeLink® indicator light in view while programming.

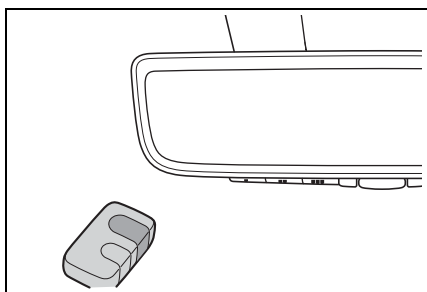

- 3 Program a device.

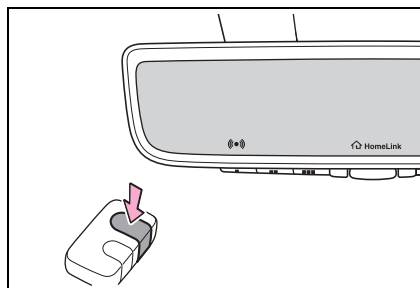

- ▶ Programming a device other than an entry gate (for U.S.A. owners)

Press and hold the remote control transmitter button until the HomeLink® indicator light changes from slowly flashing orange to rapidly flashing green (rolling code) or continuously lit green (fixed code), then release the button.

- ▶ Programming an entry gate (for U.S.A. owners)/Programming a device in the Canadian market

Press and release the remote control transmitter button at 2 second intervals, repeatedly, until the HomeLink® indicator light changes from slowly flashing orange to rapidly flashing (green) (rolling code) or continuously lit (green) (fixed code).

- 4 Test the HomeLink® operation by pressing the newly programmed button and observing the HomeLink® indicator light:

- HomeLink<sup>®</sup> indicator light illuminates: Programming of a fixed code device has completed. The garage door or other device should operate when a HomeLink<sup>®</sup> button is pressed and released.
  - HomeLink<sup>®</sup> indicator light flashes rapidly: The garage door opener or other device is equipped with a rolling code. To complete programming, firmly press and hold the HomeLink<sup>®</sup> button for 2 seconds then release it.
  - If the garage door or other device does not operate, proceed to “Programming a rolling code system”.
- 5 Repeat the steps above to program another device for any of the remaining HomeLink<sup>®</sup> buttons.

■ **Programming a rolling code system**

Two or more people may be needed to complete rolling code programming.

- 1 Locate the “Learn” or “Smart” button on the garage door opener motor in the garage.

This button can usually be found where the hanging antenna wire is attached to the unit. The name and color of the button may vary by manufacturer. Refer to the owner’s manual supplied with the garage

door opener motor for details.

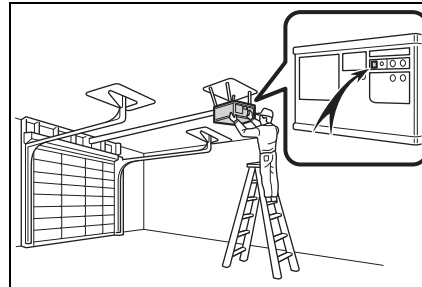

- 2 Press and release the “Learn” or “Smart” button.

Perform 3 within 30 seconds after performing 2.

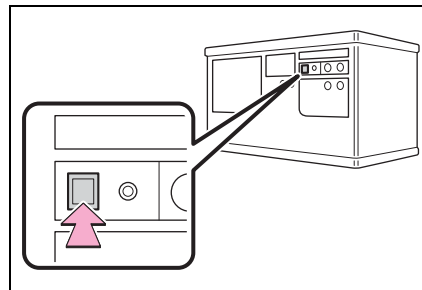

- 3 Press and hold the desired HomeLink<sup>®</sup> button (inside the vehicle) for 2 seconds and release it. Repeat this sequence (press/hold/release) up to 3 times to complete programming.

If the garage door opener motor operates when the HomeLink<sup>®</sup> button is pressed, the garage door opener motor recognizes the HomeLink<sup>®</sup> signal.



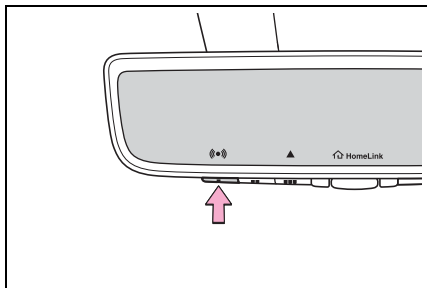

■ **Enabling 2-way communication with a garage door (only available for compatible devices)**

When enabled, 2-way communication allows you to check the status of the opening and closing of a garage door through indicators in your vehicle.

2-way communication is only available if the garage door opener motor used is a compatible device. (To check device compatibility, refer to [www.homelink.com](http://www.homelink.com).)

- 1 Within 5 seconds after programming the garage door opener has been completed, if the garage door opener motor is trained to HomeLink®, both garage door operation indicators will flash rapidly (green) and the light on the garage door opener motor will blink twice, indicating that 2-way communication is enabled.

If the indicators do not flash, perform 2 and 3 within the first 10 presses of the HomeLink® button after programming has been com-

pleted.

- 2 Press a programmed HomeLink® button to operate a garage door.
- 3 Within 1 minute of pressing the HomeLink® button, after the garage door operation has stopped, press the “Learn” or “Smart” button on the garage door opener motor. Within 5 seconds of the establishment of 2-way communication with the garage door opener, both garage door operation indicators in the vehicle will flash rapidly (green) and the light on the garage door opener motor will blink twice, indicating that 2-way communication is enabled.

■ **Reprogramming a single HomeLink® button**

When the following procedure is performed, buttons which already have devices registered to them can be overwritten:

- 1 Press and hold the desired HomeLink® button.
- 2 When the HomeLink® indicator starts flashing orange, release the HomeLink® button and perform “Programming HomeLink®” 1 (it takes 20 seconds for the HomeLink® indicator to start flashing).

**Before programming**

- Install a new battery in the transmitter.
- The battery side of the transmitter must be pointed away from the HomeLink® buttons.

**Operating HomeLink®**

Press the appropriate HomeLink® button. The HomeLink® indicator light should turn on.

The status of the opening and closing of a garage door is shown by the garage door operation indicators.

- ▶ Vehicles with auto anti-glare inside rear view mirror

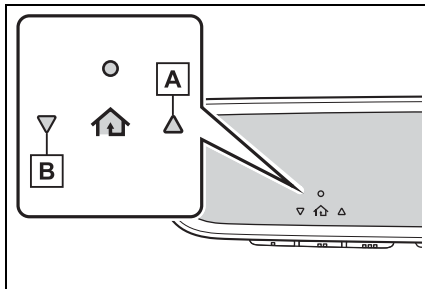

- A** Opening
- B** Closing

- ▶ Vehicles with Digital Rear-view Mirror

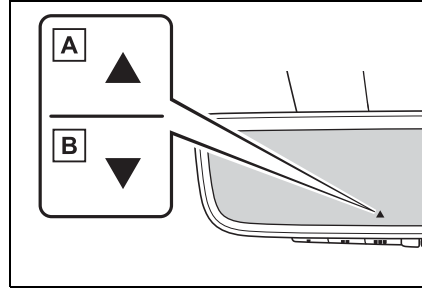









- A** Opening
- B** Closing

This function is only available if the garage door opener motor used is a compatible device. (To check device compatibility, refer to [www.homelink.com](http://www.homelink.com).)

Color	Status
Orange (flashing)	Currently opening/closing
Green	Opening/closing has completed
Red (flashing)	Feedback signals cannot be received

The indicators can operate within approximately 820 ft. (250 m) of the garage door. However, if there are obstructions between the garage door and the vehicle, such as houses and trees, feedback signals from the garage door may not be received.

To recall the previous door operation status, press and release either HomeLink® buttons 

and  or  and  (vehicles with auto anti-glare inside rear view mirror),  and  or  and  (vehicles with Digital Rear-view Mirror) simultaneously. The last recorded status will be displayed for 3 seconds.

**Erasing the entire HomeLink® memory (all three codes)**

Press and hold the 2 outside buttons for 10 seconds until the HomeLink® indicator light changes from continuously lit (orange) to rapidly flashing (green).

If you sell your vehicle, be sure to erase the programs stored in the HomeLink® memory.

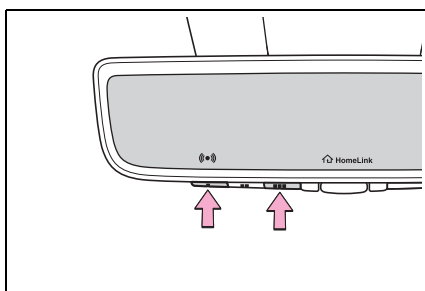



**Maintenance and care****7****7-1. Maintenance and care**

Cleaning and protecting the  
vehicle exterior ..... 558

Cleaning and protecting the  
vehicle interior ..... 561

**7-2. Maintenance**

Maintenance requirements  
..... 564

General maintenance.. 565

Emission inspection and  
maintenance (I/M) pro-  
grams ..... 568

**7-3. Do-it-yourself main-  
tenance**

Do-it-yourself service pre-  
cautions..... 569

Hood ..... 571

Positioning a floor jack 572

Engine compartment... 574

Tires ..... 581

Tire inflation pressure.. 595

Wheels ..... 597

Air conditioning filter.... 599

Wiper insert replacement  
..... 601

Wireless remote con-  
trol/electronic key battery  
..... 604

Checking and replacing  
fuses..... 607

Light bulbs..... 609

## Cleaning and protecting the vehicle exterior

**Perform the following to protect the vehicle and maintain it in prime condition:**

### Cleaning instructions

- Working from top to bottom, liberally apply water to the vehicle body, wheel wells and underside of the vehicle to remove any dirt and dust.
- Wash the vehicle body using a sponge or soft cloth, such as a chamois.
- For hard-to-remove marks, use car wash soap and rinse thoroughly with water.
- Wipe away any water.
- Wax the vehicle when the waterproof coating deteriorates.

If water does not bead on a clean surface, apply wax when the vehicle body is cool.

#### ■ Automatic car washes

- Before washing the vehicle:
  - Fold the mirrors
  - Turn off the power back door (if equipped)

Start washing from the front of the vehicle. Make sure to extend the mirrors before driving.

- Brushes used in automatic car

washes may scratch the vehicle surface and harm your vehicle's paint.

- Rear spoiler may not be washable in some automatic car washes. There may also be an increased risk of damage to vehicle.

#### ■ High pressure car washes

As water may enter the cabin, do not bring the nozzle tip near the gaps around the doors or perimeter of the windows, or spray these areas continuously.

#### ■ Note for a smart key system (if equipped)

If the door handle becomes wet while the electronic key is within the effective range, the door may lock and unlock repeatedly. In that case, follow the following correction procedures to wash the vehicle:

- Place the key in a position 6 ft. (2 m) or more separate from the vehicle while the vehicle is being washed. (Take care to ensure that the key is not stolen.)
- Set the electronic key to battery-saving mode to disable the smart key system. (→P.129)

#### ■ Aluminum wheels (if equipped)

- Remove any dirt immediately by using a neutral detergent.
- Wash detergent off with water immediately after use.
- To protect the paint from damage, make sure to observe the following precautions.
  - Do not use acidic, alkaline or abrasive detergent.
  - Do not use hard brushes.
  - Do not use detergent on the wheels when they are hot, such as after driving or parking in hot weather.
- For vehicles with 18-inch matte painted wheels and 19-inch matte painted wheels: The wheels are not maintained in the same way as normal aluminum wheels. For

details, contact your Toyota dealer.

- When washing the vehicle, use water to wash off dirt. If the vehicle is particularly dirty, use a diluted neutral detergent and a sponge or a soft cloth and wash off the dirt by hand.
- Wash detergent off with water immediately after use. After using detergent, wash the detergent off with water and wipe the vehicle dry with a soft cloth.
- For vehicles with 18-inch matte painted wheels and 19-inch matte painted wheels: Make sure to observe the following precautions to prevent damage to the matte paint.
  - Do not polish or scrub with dry cloths, brushes, etc.
  - Do not use detergents containing coatings or abrasives.
  - If using an automatic car wash, make sure it does not include dedicated wheel brushes.
  - Do not use high-pressure spray guns or steam cleaners.
  - Do not use detergent on the wheels when they are hot, such as after driving or parking in hot weather.

#### ■ Bumpers

Do not scrub with abrasive cleaners.

#### ■ Plated portions

If dirt cannot be removed, clean the parts as follows:

- Use a soft cloth dampened with an approximately 5% solution of neutral detergent and water to clean the dirt off.
- Wipe the surface with a dry, soft cloth to remove any remaining moisture.
- To remove oily deposits, use alcohol wet wipes or a similar product.

### ⚠ WARNING

#### ■ When washing the vehicle

Do not apply water to the inside of the engine compartment. Doing so may cause the electrical components, etc. to catch fire.

#### ■ When cleaning the windshield (vehicles with rain-sensing windshield wipers)

Set the wiper switch to off. If the wiper switch is in "AUTO", the wipers may operate unexpectedly in the following situations, and may result in hands being caught or other serious injuries and cause damage to the wiper blades.

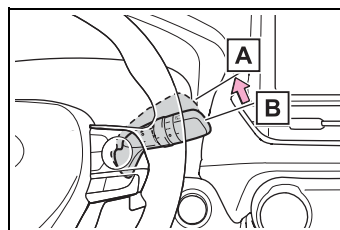

A Off

B AUTO

- When the upper part of the windshield where the raindrop sensor is located is touched by hand
- When a wet rag or similar is held close to the raindrop sensor
- If something bumps against the windshield
- If you directly touch the raindrop sensor body or if something bumps into the raindrop sensor

**⚠ WARNING****■ Precautions regarding the exhaust pipes**

Exhaust gasses cause the exhaust pipes to become quite hot.

When washing the vehicle, be careful not to touch the pipes until they have cooled sufficiently, as touching hot exhaust pipes can cause burns.

**■ Precaution regarding the rear bumper with Blind Spot Monitor (if equipped)**

If the paint of the rear bumper is chipped or scratched, the system may malfunction. If this occurs, consult your Toyota dealer.

**⚠ NOTICE****■ To prevent paint deterioration and corrosion on the body and components (aluminum wheels, etc.)**

- Wash the vehicle immediately in the following cases:
  - After driving near the sea coast
  - After driving on salted roads
  - If coal tar or tree sap is present on the paint surface
  - If dead insects, insect droppings or bird droppings are present on the paint surface
  - After driving in an area contaminated with soot, oily smoke, mine dust, iron powder or chemical substances
  - If the vehicle becomes heavily soiled with dust or mud
  - If liquids such as benzene and gasoline are spilled on the paint surface

- If the paint is chipped or scratched, have it repaired immediately.

- To prevent the wheels from corroding, remove any dirt and store in a place with low humidity when storing the wheels.

**■ Cleaning the exterior lights**

- Wash carefully. Do not use organic substances or scrub with a hard brush. This may damage the surfaces of the lights.
- Do not apply wax to the surfaces of the lights. Wax may cause damage to the lenses.

**■ When using an automatic car wash (vehicles with rain-sensing windshield wipers)**

Set the wiper switch to off position.

If the wiper switch is in "AUTO", the wipers may operate and the wiper blades may be damaged.

**■ When using a high pressure car wash**

- When washing the vehicle, do not let water from the high-pressure washer directly hit the camera or the area around the camera. Due to the shock from the high pressure water, it is possible that the device may not operate normally.
- Do not bring the nozzle tip close to boots (rubber or resin manufactured cover), or connectors or the following parts. The parts may be damaged if they come into contact with high-pressure water.
  - Traction related parts
  - Steering parts
  - Suspension parts
  - Brake parts



**NOTICE**

- Keep the cleaning nozzle at least 11.9 in. (30 cm) away from the vehicle body. Otherwise resin section, such as moldings and bumpers, may be deformed and damaged. Also, do not continuously hold the nozzle in the same place.
- Do not spray the lower part of the windshield continuously. If water enters the air conditioning system intake located near the lower part of the windshield, the air conditioning system may not operate correctly.

**Cleaning and protecting the vehicle interior**

**Perform cleaning in a manner appropriate to each component and its material.**

**Protecting the vehicle interior**

- Remove dirt and dust using a vacuum cleaner. Wipe dirty surfaces with a cloth dampened with lukewarm water.
- If dirt cannot be removed, wipe it off with a soft cloth dampened with neutral detergent diluted to approximately 1%.  
Wring out any excess water from the cloth and thoroughly wipe off remaining traces of detergent and water.

**Shampooing the carpets**

There are several commercial foaming-type cleaners available. Use a sponge or brush to apply the foam. Rub in overlapping circles. Do not use water. Wipe dirty surfaces and let them dry. Excellent results are obtained by keeping the carpet as dry as possible.

**Handling the seat belts**

Clean with mild soap and lukewarm water using a cloth or sponge. Also check the belts periodically for excessive wear, fraying or cuts.

**⚠ WARNING****■ Water in the vehicle**

- Do not splash or spill liquid in the vehicle.  
Doing so may cause electrical components, etc., to malfunction or catch fire.
- Do not get any of the SRS components or wiring in the vehicle interior wet.  
(→P.34)  
An electrical malfunction may cause the airbags to deploy or not function properly, resulting in death or serious injury.
- Vehicles with wireless charger: Do not let the wireless charger (→P.547) get wet. Failure to do so may cause the charger to become hot and cause burns or could cause electric shock resulting in death or serious injury.

**■ Cleaning the interior (especially instrument panel)**

Do not use a polish wax or polish cleaner. The instrument panel may reflect off the windshield, obstructing the driver's view and leading to an accident, resulting in death or serious injury.

**⚠ NOTICE****■ Cleaning detergents**

- Do not use the following types of detergent, as they may discolor the vehicle interior or cause streaks or damage to painted surfaces:
  - Non-seat portions: Organic substances such as benzene or gasoline, alkaline or acidic solutions, dye, and bleach
  - Seats: Alkaline or acidic solutions, such as thinner, benzene, and alcohol

- Do not use a polish wax or polish cleaner. The instrument panel's or other interior part's painted surface may be damaged.

**■ Preventing damage to leather surfaces**

Observe the following precautions to avoid damage to and deterioration of leather surfaces:

- Remove any dust or dirt from leather surfaces immediately.
- Do not expose the vehicle to direct sunlight for extended periods of time. Park the vehicle in the shade, especially during summer.
- Do not place items made of vinyl, plastic, or containing wax on the upholstery, as they may stick to the leather surface if the vehicle interior heats up significantly.

**■ Water on the floor**

Do not wash the vehicle floor with water.

Vehicle systems such as the audio system may be damaged if water comes into contact with electrical components such as the audio system above or under the floor of the vehicle. Water may also cause the body to rust.

**■ When cleaning the inside of the windshield**

Do not allow glass cleaner to contact the lens. Also, do not touch the lens. (→P.223)

**NOTICE****■ Cleaning the inside of the rear window**

- Do not use a glass cleaner to clean the rear window, as this may cause damage to the rear window defogger heater wires. Use a cloth dampened with lukewarm water to gently wipe the window clean. Wipe the window in strokes running parallel to the heater wires.
- Be careful not to scratch or damage the heater wires.

**■ Cleaning the leather areas**

- Remove dirt and dust using a vacuum cleaner.
- Wipe off any excess dirt and dust with a soft cloth dampened with diluted detergent.

Use a diluted water solution of approximately 5% neutral wool detergent.

- Wring out any excess water from the cloth and thoroughly wipe off all remaining traces of detergent.
- Wipe the surface with a dry, soft cloth to remove any remaining moisture. Allow the leather to dry in a shaded and ventilated area.

**■ Caring for leather areas**

Toyota recommends cleaning the interior of the vehicle at least twice a year to maintain the quality of the vehicle's interior.

**■ Cleaning the synthetic leather areas**

- Remove dirt and dust using a vacuum cleaner.
- Wipe it off with a soft cloth dampened with neutral detergent diluted to approximately 1%.
- Wring out any excess water from the cloth and thoroughly wipe off remaining traces of detergent and water.

## Maintenance requirements

**To ensure safe and economical driving, day-to-day care and regular maintenance are essential. It is the owner's responsibility to perform regular checks. Toyota recommends the following maintenance:**

### ■ Repair and replacement

It is recommended that genuine Toyota parts be used for repairs to ensure performance of each system. If non-Toyota parts are used in replacement or if a repair shop other than a Toyota dealer performs repairs, confirm the warranty coverage.

### ■ Allow inspection and repairs to be performed by a Toyota dealer

- Toyota technicians are well-trained specialists and are kept up to date with the latest service information. They are well informed about the operations of all systems on your vehicle.
- Keep a copy of the repair order. It proves that the maintenance that has been performed is under warranty coverage. If any problem should arise while your vehicle is under warranty, your Toyota dealer will promptly take care of it.

### WARNING

#### ■ If your vehicle is not properly maintained

Improper maintenance could result in serious damage to the vehicle and possible death or serious injury.

### ■ Handling of the battery

- Engine exhaust, some of its constituents, and a wide variety of automobile components contain or emit chemicals known to the State of California to cause cancer and birth defects and other reproductive harm. Work in a well ventilated area.
- Oils, fuels and fluids contained in vehicles as well as waste produced by component wear contain or emit chemicals known to the State of California to cause cancer and birth defects or other reproductive harm. Avoid exposure and wash any affected area immediately.
- Battery posts, terminals and related accessories contain lead and lead compounds which are known to cause brain damage. Wash your hands after handling. (→P.579)

## General maintenance

General maintenance should be performed on a daily basis. This can be done by yourself or by a Toyota dealer.

## Scheduled maintenance

Scheduled maintenance should be performed at specified intervals according to the maintenance schedule.

For details about maintenance items and schedules, refer to the "Scheduled Maintenance Guide" or "Owner's Manual Supplement".

**Resetting the message indicating maintenance is required**

After the required maintenance is performed according to the maintenance schedule, please reset the reminder light or message. To reset the reminder light or message, follow the procedure described below:

- 1 Press or of the meter control switches and select on the multi-information display.
- 2 Press or of the meter control switches and select "Vehicle Settings". Then press .
- 3 Press or of the meter control switches and select "Scheduled Maintenance". Then press .
- 4 Select "Yes" and press .

**Do-it-yourself maintenance**

You can perform some maintenance procedures by yourself. Please be aware that do-it-yourself maintenance may affect warranty coverage.

The use of Toyota Repair Manuals is recommended.

For details about warranty coverage, refer to the separate "Owner's Warranty Information Booklet" or "Owner's Manual Supplement".

**General maintenance**

Listed below are the general maintenance items that should be performed at the intervals specified in the "Owner's Warranty Information Booklet" or "Owner's Manual Supplement/Scheduled Maintenance Guide". It is recommended that any problem you notice should be brought to the attention of your Toyota dealer or qualified service shop for advice.

**! WARNING**

**■ If the engine is running**  
Turn the engine off and ensure that there is adequate ventilation before performing maintenance checks.

**Engine compartment**

Items	Check points
Battery	Check the connections. (→P.579)
Brake fluid	Is the brake fluid at the correct level? (→P.577)
Engine coolant	Is the engine coolant at the correct level? (→P.576)
Engine oil	Is the engine oil at the correct level? (→P.574)

Items	Check points
Exhaust system	There should not be any fumes or strange sounds.
Radiator/condenser	The radiator and condenser should be free from foreign objects. (→P.577)
Washer fluid	Is there sufficient washer fluid? (→P.579)

### Vehicle interior

Items	Check points
Accelerator pedal	<ul style="list-style-type: none"> <li>The accelerator pedal should move smoothly (without uneven pedal effort or catching).</li> </ul>
Automatic transmission "Park" mechanism	<ul style="list-style-type: none"> <li>When parked on a slope and the shift position is in P, is the vehicle securely stopped?</li> </ul>
Brake pedal	<ul style="list-style-type: none"> <li>Does the brake pedal move smoothly?</li> <li>Does the brake pedal have appropriate clearance from the floor?</li> <li>Does the brake pedal have the correct amount of free play?</li> </ul>

Items	Check points
Brakes	<ul style="list-style-type: none"> <li>The vehicle should not pull to one side when the brakes are applied.</li> <li>The brakes should work effectively.</li> <li>The brake pedal should not feel spongy.</li> <li>The brake pedal should not get too close to the floor when the brakes are applied.</li> </ul>
Head restraints	<ul style="list-style-type: none"> <li>Do the head restraints move smoothly and lock securely?</li> </ul>
Indicators/buzzers	<ul style="list-style-type: none"> <li>Do the indicators and buzzers function properly?</li> </ul>
Lights	<ul style="list-style-type: none"> <li>Do all the lights come on?</li> </ul>
Parking brake	<ul style="list-style-type: none"> <li>Does the parking brake operate normally?</li> <li>When parked on a slope and the parking brake is on, is the vehicle securely stopped?</li> </ul>

Items	Check points
Seat belts	<ul style="list-style-type: none"> <li>• Do the seat belts operate smoothly?</li> <li>• The seat belts should not be damaged.</li> </ul>
Seats	<ul style="list-style-type: none"> <li>• Do the seat controls operate properly?</li> </ul>
Steering wheel	<ul style="list-style-type: none"> <li>• Does the steering wheel rotate smoothly?</li> <li>• Does the steering wheel have the correct amount of free play?</li> <li>• There should not be any strange sounds coming from the steering wheel.</li> </ul>

**Vehicle exterior**

Items	Check points
Doors	<ul style="list-style-type: none"> <li>• Do the doors operate smoothly?</li> </ul>
Engine hood	<ul style="list-style-type: none"> <li>• Does the engine hood lock system work properly?</li> </ul>
Fluid leaks	<ul style="list-style-type: none"> <li>• There should not be any signs of fluid leakage after the vehicle has been parked.</li> </ul>

Items	Check points
Tires	<ul style="list-style-type: none"> <li>• Is the tire inflation pressure correct?</li> <li>• The tires should not be damaged or excessively worn.</li> <li>• Have the tires been rotated according to the maintenance schedule?</li> <li>• The wheel nuts should not be loose.</li> </ul>
Windshield wipers/rear window wiper	<ul style="list-style-type: none"> <li>• The wiper blades should not show any signs of cracking, splitting, wear, contamination or deformation.</li> <li>• The wiper blades should clear the windshield without streaking or skipping.</li> </ul>

### Emission inspection and maintenance (I/M) programs

**Some states have vehicle emission inspection programs which include OBD (On Board Diagnostics) checks. The OBD system monitors the operation of the emission control system.**

### If the malfunction indicator lamp comes on

The OBD system determines that a problem exists somewhere in the emission control system. Your vehicle may not pass the I/M test and may need to be repaired. Contact your Toyota dealer to service the vehicle.

### Your vehicle may not pass the I/M test in the following situations:

- When the battery is disconnected or discharged  
Readiness codes that are set during ordinary driving are erased.  
Also, depending on your driving habits, the readiness codes may not be completely set.
- When the fuel tank cap is

loose

The malfunction indicator lamp comes on indicating a temporary malfunction and your vehicle may not pass the I/M test.

### When the malfunction indicator lamp still remains on after several driving trips

The error code in the OBD system will not be cleared unless the vehicle is driven 40 or more times.

### If your vehicle does not pass the I/M test

Contact your Toyota dealer to prepare the vehicle for re-testing.



**Do-it-yourself service precautions**

**If you perform maintenance by yourself, be sure to follow the correct procedure as given in these sections.**

**Maintenance**

Items	Parts and tools
Battery condition (→P.579)	<ul style="list-style-type: none"> <li>• Grease</li> <li>• Conventional wrench (for terminal clamp bolts)</li> </ul>
Brake fluid level (→P.577)	<ul style="list-style-type: none"> <li>• FMVSS No.116 DOT 3 or SAE J1703 brake fluid</li> <li>• FMVSS No.116 DOT 4 or SAE J1704</li> <li>• Rag or paper towel</li> <li>• Funnel (used only for adding brake fluid)</li> </ul>

Items	Parts and tools
Engine coolant level (→P.576)	<ul style="list-style-type: none"> <li>• “Toyota Super Long Life Coolant” or a similar high quality ethylene glycol-based non-silicate, non-amine, non-nitrite and non-borate coolant with long-life hybrid organic acid technology For the U.S.A.: “Toyota Super Long Life Coolant” is pre-mixed with 50% coolant and 50% deionized water. For Canada: “Toyota Super Long Life Coolant” is pre-mixed with 55% coolant and 45% deionized water.</li> <li>• Funnel (used only for adding coolant)</li> </ul>
Engine oil level (→P.574)	<ul style="list-style-type: none"> <li>• “Toyota Genuine Motor Oil” or equivalent</li> <li>• Rag or paper towel</li> <li>• Funnel (used only for adding engine oil)</li> </ul>
Fuses (→P.607)	<ul style="list-style-type: none"> <li>• Fuse with same amperage rating as original</li> </ul>

Items	Parts and tools
Light bulbs (→P.609)	<ul style="list-style-type: none"> <li>• Bulb with same number and wattage rating as original</li> <li>• Phillips-head screwdriver</li> <li>• Flathead screwdriver</li> <li>• Wrench</li> </ul>
Radiator and condenser (→P.577)	—
Tire inflation pressure (→P.595)	<ul style="list-style-type: none"> <li>• Tire pressure gauge</li> <li>• Compressed air source</li> </ul>
Washer fluid (→P.580)	<ul style="list-style-type: none"> <li>• Water or washer fluid containing antifreeze (for winter use)</li> <li>• Funnel (used only for adding water or washer fluid)</li> </ul>

- Do not leave anything that may burn easily, such as paper and rags, in the engine compartment.
- Do not smoke, cause sparks or expose an open flame to fuel or the battery. Fuel and battery fumes are flammable.
- Be extremely cautious when working on the battery. It contains poisonous and corrosive sulfuric acid.

■ **When working near the electric cooling fan or radiator grille**

Be sure the engine switch is off. With the engine switch in ON, the electric cooling fan may automatically start to run if the air conditioning is on and/or the coolant temperature is high. (→P.577)

■ **Safety glasses**

Wear safety glasses to prevent flying or falling material, fluid spray, etc., from getting in your eyes.

 **WARNING**

The engine compartment contains many mechanisms and fluids that may move suddenly, become hot, or become electrically energized. To avoid death or serious injury, observe the following precautions.

■ **When working on the engine compartment**

- Keep hands, clothing and tools away from the moving fan and engine drive belt.
- Be careful not to touch the engine, radiator, exhaust manifold, etc., right after driving as they may be hot. Oil and other fluids may also be hot.

 **NOTICE**

■ **If you remove the air cleaner filter**

Driving with the air cleaner filter removed may cause excessive engine wear due to dirt in the air.

Hood

**Release the lock from the inside of the vehicle to open the hood.**

**Opening the hood**

- 1 Pull the hood lock release lever.

The hood will pop up slightly.

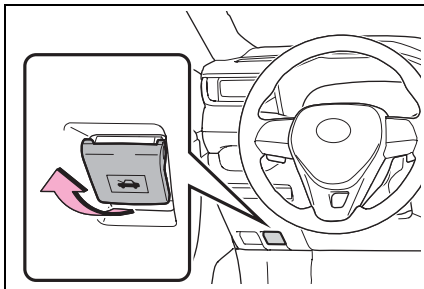

- 2 Push the auxiliary catch lever to the left and lift the hood.

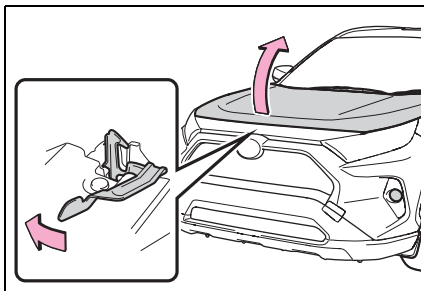

- 3 Hold the hood open by inserting the supporting rod into the slot.

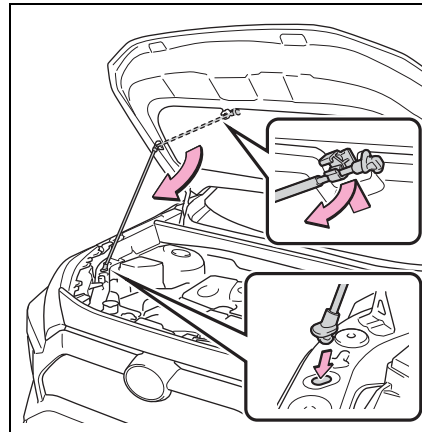

**⚠ WARNING**

■ **Pre-driving check**

Check that the hood is fully closed and locked.

If the hood is not locked properly, it may open while the vehicle is in motion and cause an accident, which may result in death or serious injury.

■ **After installing the support rod into the slot**

Make sure the rod supports the hood securely from falling down on to your head or body.

■ **When closing the hood**

When closing the hood, take extra care to prevent your fingers etc. from being caught.

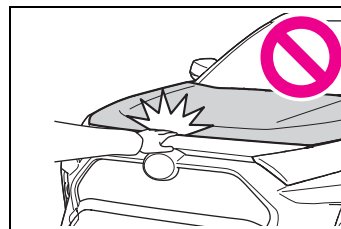



**NOTICE**

**When closing the hood**

Be sure to return the support rod to its clip before closing the hood. Closing the hood without returning the support rod properly could cause the hood to bend.

### Positioning a floor jack

**When using a floor jack, follow the instructions in the manual provided with the jack and perform the operation safely.**

**When raising your vehicle with a floor jack, position the jack correctly.**

**Improper placement may damage your vehicle or cause injury.**

### Location of the jack point

■ **Front**

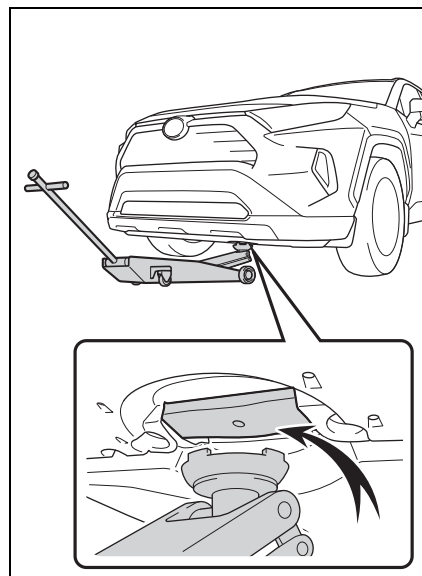

■ Rear

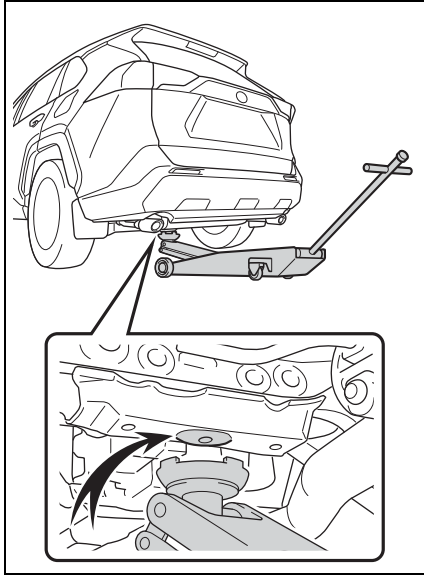

## Engine compartment

### Components

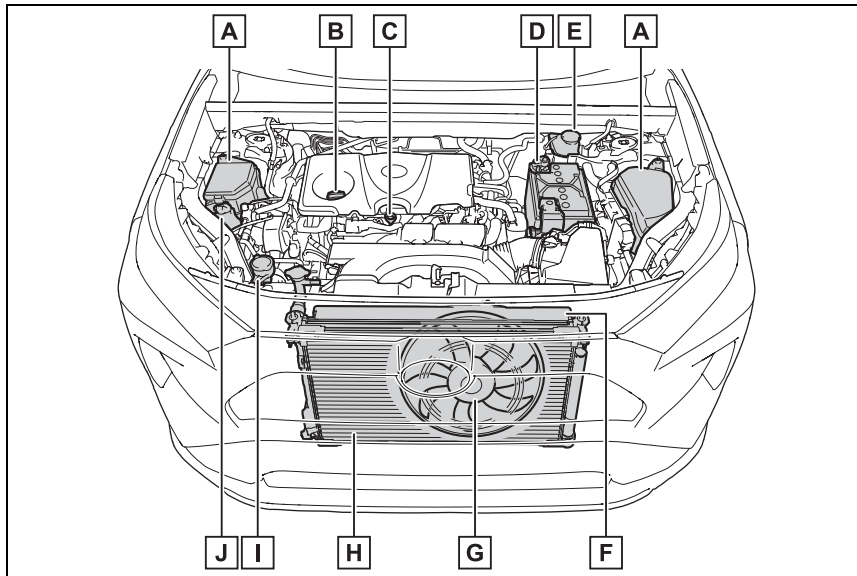

- A** Fuse boxes (→P.607)
- B** Engine oil filler cap (→P.575)
- C** Engine oil level dipstick (→P.574)
- D** Battery (→P.579)
- E** Brake fluid reservoir (→P.577)
- F** Radiator (→P.577)
- G** Electric cooling fan
- H** Condenser (→P.577)
- I** Washer fluid tank (→P.580)
- J** Engine coolant reservoir (→P.576)

### Checking and adding the engine oil

check the oil level on the dipstick.

With the engine at operating temperature and turned off,

■ **Checking the engine oil**

- 1 Park the vehicle on level ground. After warming up the engine and turning off the engine, wait more than 5 minutes for the oil to drain back into the bottom of the engine.
- 2 Holding a rag under the end, pull the dipstick out.

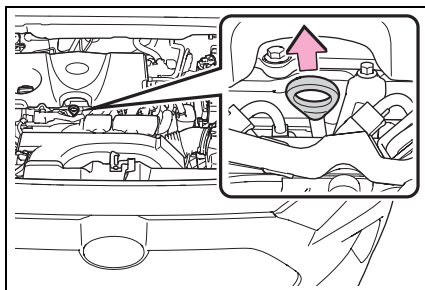

- 3 Wipe the dipstick clean.
- 4 Reinsert the dipstick fully.
- 5 Holding a rag under the end, pull the dipstick out and check the oil level.

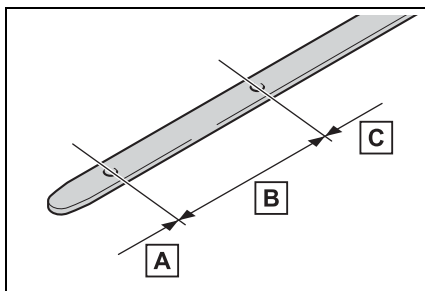

- A** Low
- B** Normal
- C** Excessive

The shape of the dipstick may differ depending on the type of vehicle or engine.

- 6 Wipe the dipstick and reinsert it fully.

■ **Checking the oil type and preparing the items needed**

Make sure to check the oil type and prepare the items needed before adding oil.

- Engine oil selection  
→P.666
- Oil quantity (Low → Full)  
1.6 qt. (1.5 L, 1.3 Imp. qt.)

- Item

Clean funnel

■ **Adding engine oil**

If the oil level is below or near the low level mark, add engine oil of the same type as that already in the engine.

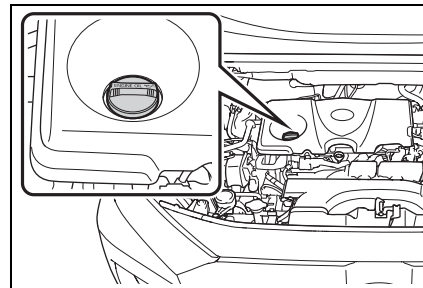

- 1 Remove the oil filler cap by turning it counterclockwise.
- 2 Add engine oil slowly, checking the dipstick.
- 3 Install the oil filler cap by turning it clockwise.

■ **Engine oil consumption**

A certain amount of engine oil will be consumed while driving. In the following situations, oil consump-

tion may increase, and engine oil may need to be refilled in between oil maintenance intervals.

- When the engine is new, for example directly after purchasing the vehicle or after replacing the engine
- If low quality oil or oil of an inappropriate viscosity is used
- When driving at high engine speeds or with a heavy load, when towing, or when driving while accelerating or decelerating frequently
- When leaving the engine idling for a long time, or when driving frequently through heavy traffic

#### WARNING

##### ■ Used engine oil

- Used engine oil contains potentially harmful contaminants which may cause skin disorders such as inflammation and skin cancer, so care should be taken to avoid prolonged and repeated contact. To remove used engine oil from your skin, wash thoroughly with soap and water.
- Dispose of used oil and filters only in a safe and acceptable manner. Do not dispose of used oil and filters in household trash, in sewers or onto the ground. Call your Toyota dealer, service station or auto parts store for information concerning recycling or disposal.
- Do not leave used engine oil within the reach of children.

#### NOTICE

##### ■ To prevent serious engine damage

Check the oil level on a regular basis.

##### ■ When replacing the engine oil

- Be careful not to spill engine oil on the vehicle components.
- Avoid overfilling, or the engine could be damaged.
- Check the oil level on the dipstick every time you refill the vehicle.
- Be sure the engine oil filler cap is properly tightened.

##### ■ If oil is spilled on the engine cover

To prevent the engine cover from being damaged, remove any engine oil from the engine cover as soon as possible using a neutral detergent. Do not use an organic solvent such as brake cleaner.

### Checking the coolant

The coolant level is satisfactory if it is between the “FULL” and “LOW” lines on the reservoir when the engine is cold.

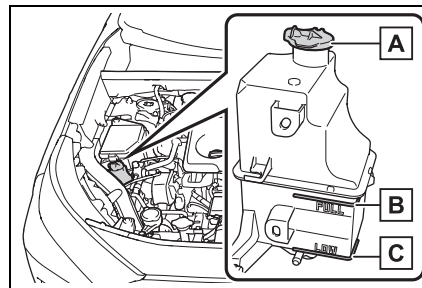

**A** Reservoir cap

**B** “FULL” line

**C** “LOW” line

If the level is on or below the “LOW” line, add coolant up to the “FULL” line. (→P.659)



**■ Coolant selection**

Only use “Toyota Super Long Life Coolant” or a similar high quality ethylene glycol based non-silicate, non-amine, non-nitrite, and non-borate coolant with long-life hybrid organic acid technology.

U.S.A.:

“Toyota Super Long Life Coolant” is a mixture of 50% coolant and 50% deionized water. (Minimum temperature: -31°F [-35°C])

Canada:

“Toyota Super Long Life Coolant” is a mixture of 55% coolant and 45% deionized water. (Minimum temperature: -44°F [-42°C])

For more details about coolant, contact your Toyota dealer.

**■ If the coolant level drops within a short time of replenishing**

Visually check the radiators, hoses, engine/power control unit coolant reservoir caps, drain cock and water pump.

If you cannot find a leak, have your Toyota dealer, test the cap and check for leaks in the cooling system.

 **WARNING**

**■ When the engine is hot**

Do not remove the engine coolant reservoir cap. The cooling system may be under pressure and may spray hot coolant if the cap is removed, causing serious injuries, such as burns.

 **NOTICE**

**■ When adding coolant**

Coolant is neither plain water nor straight antifreeze. The correct mixture of water and antifreeze must be used to provide proper lubrication, corrosion protection and cooling. Be sure to read the antifreeze or coolant label.

**■ If you spill coolant**

Be sure to wash it off with water to prevent it from damaging parts or paint.

**Checking the radiator and condenser**

Check the radiator and condenser, and clear away any foreign objects.

If either of the above parts is extremely dirty or you are not sure of their condition, have your vehicle inspected by your Toyota dealer.

 **WARNING**

**■ When the engine is hot**

Do not touch the radiator or condenser as they may be hot and cause serious injuries, such as burns.

**■ When the electric cooling fan is operating**

Do not touch the engine compartment.

With the engine switch in ON, the electric cooling fan may automatically start to run if the air conditioning is on and/or the coolant temperature is high. Be sure the engine switch is off when working near the electric cooling fan or radiator grille.

**Checking and adding the brake fluid**

**■ Checking fluid level**

The brake fluid level should be between the “MAX” and “MIN” lines on the tank.

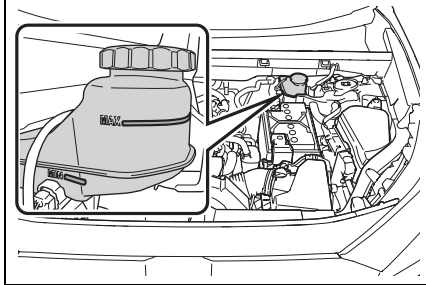

■ **Adding fluid**

- 1 Slide and lift up the rubber strip to partly remove it as shown.

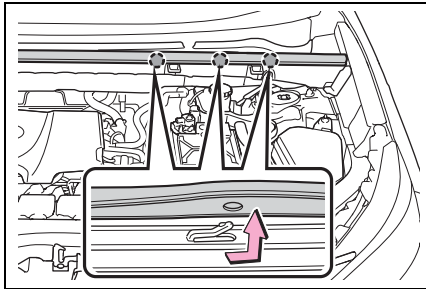

- 2 Disconnect the claws and remove the service cover.

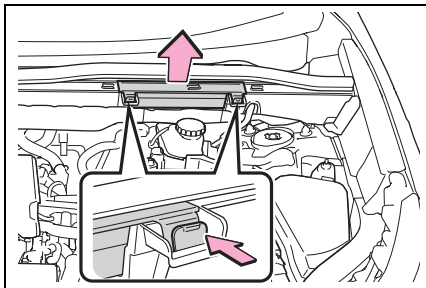

- 3 Remove the reservoir cap.

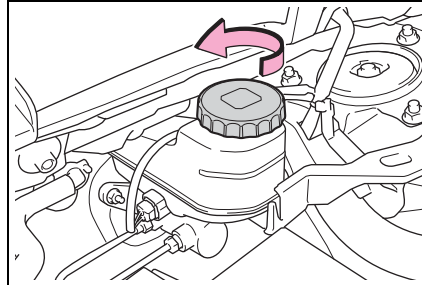

- 4 Add brake fluid slowly while checking the fluid level.

Make sure to check the fluid type and prepare the necessary item.

Fluid type	FMVSS No.116 DOT 3 or SAE J1703 brake fluid FMVSS No.116 DOT 4 or SAE J1704
Item	Clean funnel

■ **Brake fluid can absorb moisture from the air**

Excess moisture in the brake fluid can cause a dangerous loss of braking efficiency. Use only newly opened brake fluid.

**⚠ WARNING**

■ **When filling the reservoir**

Take care as brake fluid can harm your hands and eyes and damage painted surfaces.

If fluid gets on your hands or in your eyes, flush the affected area with clean water immediately.

If you still experience discomfort, see a doctor.

 NOTICE

■ **If the fluid level is low or high**

It is normal for the brake fluid level to go down slightly as the brake pads wear out or when the fluid level in the accumulator is high.

If the reservoir needs frequent refilling, there may be a serious problem.

### Checking the battery

Check the battery as follows.

#### ■ Battery exterior

Make sure that the battery terminals are not corroded and that there are no loose connections, cracks, or loose clamps.

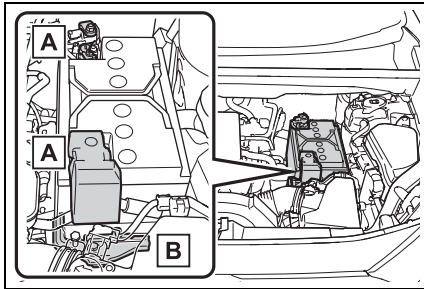

**A** Terminals

**B** Hold-down clamp

#### ■ Before recharging

When recharging, the battery produces hydrogen gas which is flammable and explosive. Therefore, observe the following precautions before recharging:

- If recharging with the battery installed on the vehicle, be sure to disconnect the ground cable.
- Make sure the power switch on the charger is off when connecting and disconnecting the charger

cables to the battery.

#### ■ After recharging/reconnecting the battery (vehicles with smart key system)

The engine may not start. Follow the procedure below to initialize the system.

- 1 Shift the shift lever to P.
  - 2 Open and close any of the doors.
  - 3 Restart the engine.
- Unlocking the doors using the smart key system may not be possible immediately after reconnecting the battery. If this happens, use the wireless remote control or the mechanical key to lock/unlock the doors.
  - Start the engine with the engine switch in ACC. The engine may not start with the engine switch turned off. However, the engine will operate normally from the second attempt.
  - The engine switch mode is recorded by the vehicle. If the battery is disconnected and reconnected, the vehicle will return the engine switch mode to the status it was in before the battery was disconnected. Make sure to turn off the engine switch before disconnecting the battery. Take extra care when connecting the battery if the engine switch mode prior to the battery being disconnected is unknown.

If the engine will not start even after multiple attempts, contact your Toyota dealer.

**⚠ WARNING****■ Chemicals in the battery**

A battery contains poisonous and corrosive sulfuric acid and may produce hydrogen gas which is flammable and explosive. To reduce the risk of death or serious injury, take the following precautions while working on or near the battery:

- Do not cause sparks by touching the battery terminals with tools.
- Do not smoke or light a match near the battery.
- Avoid contact with eyes, skin and clothes.
- Never inhale or swallow electrolyte.
- Wear protective safety glasses when working near the battery.
- Keep children away from the battery.

**■ Where to safely charge the battery**

Always charge the battery in an open area. Do not charge the battery in a garage or closed room where there is not sufficient ventilation.

**■ Emergency measures regarding electrolyte**

- If electrolyte gets in your eyes  
Flush your eyes with clean water for at least 15 minutes and get immediate medical attention. If possible, continue to apply water with a sponge or cloth while traveling to the nearest medical facility.

- If electrolyte gets on your skin  
Wash the affected area thoroughly. If you feel pain or burning, get medical attention immediately.

- If electrolyte gets on your clothes  
It can soak through clothing on to your skin. Immediately take off the clothing and follow the procedure above if necessary.

- If you accidentally swallow electrolyte  
Drink a large quantity of water or milk. Get emergency medical attention immediately.

**■ When there is insufficient battery fluid**

Do not use if there is insufficient fluid in the battery. There is a possible danger that the battery may explode.

**⚠ NOTICE****■ When recharging the battery**

Never recharge the battery while the engine is running. Also, be sure all accessories are turned off.

**Adding the washer fluid**

If any washer does not work or the warning message appears on the multi-information display, the washer tank may be empty. Add washer fluid.

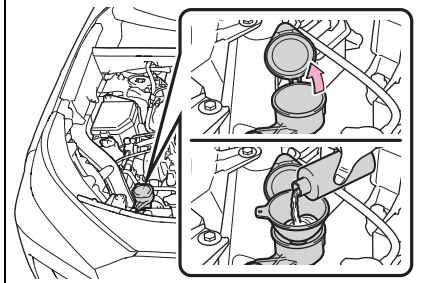

**⚠ WARNING**

■ **When adding washer fluid**

Do not add washer fluid when the engine is hot or running as washer fluid contains alcohol and may catch fire if spilled on the engine, etc.

**⚠ NOTICE**

■ **Do not use any fluid other than washer fluid**

Do not use soapy water or engine antifreeze instead of washer fluid. Doing so may cause streaking on the vehicle's painted surfaces, as well as damaging the pump leading to problems of the washer fluid not spraying.

■ **Diluting washer fluid**

Dilute washer fluid with water as necessary. Refer to the freezing temperatures listed on the label of the washer fluid bottle.

**Tires**

**Replace or rotate tires in accordance with maintenance schedules and treadwear.**

**Checking tires**

Check if the treadwear indicators are showing on the tires. Also check the tires for uneven wear, such as excessive wear on one side of the tread. Check the spare tire condition and pressure if not rotated.

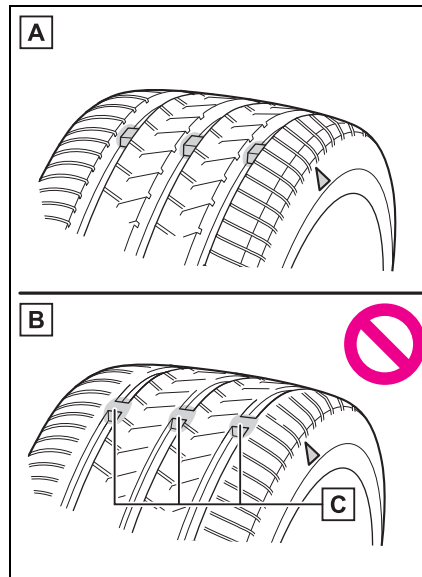

**A** New tread

**B** Worn tread

**C** Treadwear indicator

The location of treadwear indicators is shown by a "TWI" or "△" mark,

etc., molded into the sidewall of each tire.

Replace the tires if the treadwear indicators are showing on a tire.

#### ■ When to replace your vehicle's tires

Tires should be replaced if:

- The treadwear indicators are showing on a tire.
- You have tire damage such as cuts, splits, cracks deep enough to expose the fabric, and bulges indicating internal damage.
- A tire goes flat repeatedly or cannot be properly repaired due to the size or location of a cut or other damage.

If you are not sure, consult with your Toyota dealer.

#### ■ Tire life

Any tire over 6 years old must be checked by a qualified technician even if it has seldom or never been used or damage is not obvious.

#### ■ Maximum load of tire

Check that the maximum load of the replacement tire is greater than 1/2 of the Gross Axle Weight Ratings (GAWR) of either the front axle or the rear axle, whichever is greater.

For the GAWR, see the Certification Regulation Label. For the maximum load of the tire, see the load limit at maximum cold tire inflation pressure mentioned on the sidewall of the tire. (→P.678)

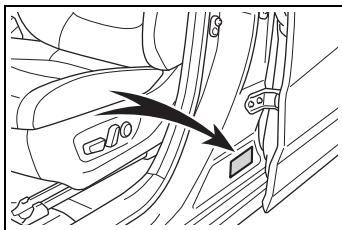

#### ■ Tire types

- Summer tires

Summer tires are high-speed performance tires best suited to highway driving under dry conditions. Since summer tires do not have the same traction performance as snow tires, summer tires are inadequate for driving on snow-covered or icy roads. For driving on snow-covered roads or icy roads, the use of snow tires is recommended. When installing snow tires, be sure to replace all four tires.

#### ● All season tires

All season tires are designed to provide better traction in snow and to be adequate for driving in most winter conditions as well as for use year-round. All season tires, however, do not have adequate traction performance compared with snow tires in heavy or loose snow. Also, all season tires fall short in acceleration and handling performance compared with summer tires in highway driving.

#### ● Snow tires

For driving on snow-covered roads or icy roads, we recommend using snow tires. If you need snow tires, select tires of the same size, construction and load capacity as the originally installed tires. Since your vehicle has radial tires as original equipment, make sure your snow tires also have radial construction. Do not install studded tires without first checking local regulations for possible restrictions. Snow tires should be installed on all wheels. (→P.367)

#### ■ If the tread on snow tires wears down below 0.16 in. (4 mm)

The effectiveness of the tires as snow tires is lost.

**⚠ WARNING**

■ **When inspecting or replacing tires**

Observe the following precautions to prevent accidents. Failure to do so may cause damage to parts of the drive train as well as dangerous handling characteristics, which may lead to an accident resulting in death or serious injury.

- Do not mix tires of different makes, models or tread patterns. Also, do not mix tires of remarkably different treadwear.
- Do not use tire sizes other than those recommended by Toyota.
- Do not mix differently constructed tires (radial, bias-belted or bias-ply tires).
- Do not mix summer, all season and snow tires.
- Do not use tires that have been used on another vehicle. Do not use tires if you do not know how they were used previously.
- Do not tow if your vehicle has a compact spare tire installed.

■ **If tire inflation pressure of each tire becomes low while driving**

Do not continue driving, or your tires and/or wheels may be ruined.

**Tire rotation**

Rotate the tires in the order shown.

To equalize tire wear and extend tire life, Toyota recommends that tire rotation is carried out at the same interval as tire inspection.

Do not fail to initialize the tire pressure warning system after tire rotation. (if equipped)

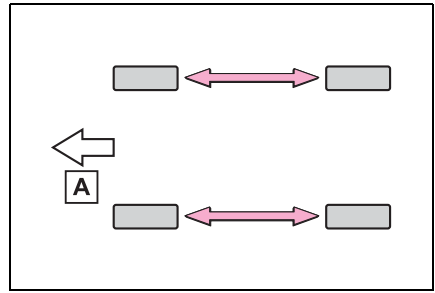

A Front

**⚠ NOTICE**

■ **Driving on rough roads**

Take particular care when driving on roads with loose surfaces or potholes. These conditions may cause losses in tire inflation pressure, reducing the cushioning ability of the tires. In addition, driving on rough roads may cause damage to the tires themselves, as well as the vehicle's wheels and body.

■ **When rotating the tires (vehicles with tire pressure warning system)**

Make sure that the engine switch is OFF. If the tires are rotated while the engine switch is in ON, the tire position information will not be updated. If this accidentally occurs, either turn the engine switch to OFF and then to ON, or initialize the system after checking that the tire pressure is properly adjusted.

### Tire pressure warning system (if equipped)

Your vehicle is equipped with a tire pressure warning system that uses tire pressure warning valves and transmitters to detect low tire inflation pressure before serious problems arise.

- If the tire pressure drops below a predetermined level, the driver is warned a screen display\* and by a warning light. (→P.634)

\*: Vehicles with tire inflation pressure display function only

- Vehicles with tire inflation pressure display function only: The tire pressure detected by the tire pressure warning system can be displayed on the multi-information display. (→P.85)

The illustration used is intended as an example, and may differ from the image that is actually displayed on the multi-information display.



### Routine tire inflation pressure checks

The tire pressure warning system does not replace routine tire inflation pressure checks. Make sure to check tire inflation pressure as part of your routine of daily vehicle checks.

### Tire inflation pressure\*

\*: Vehicles with tire inflation pressure display function only

- It may take a few minutes to display the tire inflation pressure after the engine switch is turned to ON. It may also take a few minutes to display the tire inflation pressure after inflation pressure has been adjusted.
- Tire inflation pressure changes with temperature. The displayed values may also be different from the values measured using a tire pressure gauge.

### Situations in which the tire pressure warning system may not operate properly (if equipped)

- In the following cases, the tire pressure warning system may not operate properly.
  - If non-genuine Toyota wheels are used.
  - A tire has been replaced with a tire that is not an OE (Original Equipment) tire.
  - A tire has been replaced with a tire that is not of the specified size.
  - Tire chains, etc. are equipped.
  - An auxiliary-supported run-flat tire is equipped.
  - If a window tint that affects the radio wave signals is installed.
  - If there is a lot of snow or ice on the vehicle, particularly around the wheels or wheel housings.
  - If the tire inflation pressure is extremely higher than the specified level.
  - If wheel without tire pressure



warning valves and transmitters are used.

- If the ID code on the tire pressure warning valves and transmitters is not registered in the tire pressure warning computer.
- Performance may be affected in the following situations.
- Near a TV tower, electric power plant, gas station, radio station, large display, airport or other facility that generates strong radio waves or electrical noise
- When carrying a portable radio, cellular phone, cordless phone or other wireless communication device

If tire position information is not correctly displayed due to the radio wave conditions, the display may be corrected by driving and changing

the radio wave conditions.

- When the vehicle is parked, the time taken for the warning to start or go off could be extended.
- When tire inflation pressure declines rapidly for example when a tire has burst, the warning may not function.

#### ■ Warning performance of the tire pressure warning system (if equipped)

The warning of the tire pressure warning system will change in accordance with the conditions under which it was initialized. For this reason, the system may give a warning even if the tire pressure does not reach a low enough level, or if the pressure is higher than the pressure that was adjusted to when the system was initialized.

#### ■ Certification for tire pressure warning system

- ▶ For vehicles sold in the U.S.A., Hawaii, American Samoa, Guam, Saipan and Puerto Rico

FCC ID: PAXPMVC015

#### NOTE

This device complies with part 15 of the FCC Rules.

Operation is subject to the following two conditions:

- (1) This device may not cause harmful interference, and (2) this device must accept any interference received, including interference that may cause undesired operation.

#### FCC WARNING

Changes or modifications not expressly approved by the party responsible for compliance could void the user's authority to operate the equipment.

FCC ID: PAXPMVE000

NOTE

This device complies with part 15 of the FCC Rules. Operation is subject to the following two conditions:  
(1) This device may not cause harmful interference, and (2) this device must accept any interference received, including interference that may cause undesired operation.

FCC WARNING

Changes or modifications not expressly approved by the party responsible for compliance could void the user's authority to operate the equipment.

► For vehicles sold in Canada

NOTE

This device complies with Industry Canada licence-exempt RSS standard(s). Operation is subject to the following two conditions: (1) this device may not cause interference, and (2) this device must accept any interference, including interference that may cause undesired operation of the device.

NOTE

Le présent appareil est conforme aux CNR d'Industrie Canada applicables aux appareils radio exempts de licence. L'exploitation est autorisée aux deux conditions suivantes : (1) l'appareil ne doit pas produire de brouillage, et (2) l'utilisateur de l'appareil doit accepter tout brouillage radioélectrique subi, même si le brouillage est susceptible d'en compromettre le fonctionnement.

**NOTE**

This device complies with Industry Canada licence-exempt RSS standard(s). Operation is subject to the following two conditions: (1) this device may not cause interference, and (2) this device must accept any interference, including interference that may cause undesired operation of the device.

**NOTE**

Le présent appareil est conforme aux CNR d'Industrie Canada applicables aux appareils radio exempts de licence. L'exploitation est autorisée aux deux conditions suivantes : (1) l'appareil ne doit pas produire de brouillage, et (2) l'utilisateur de l'appareil doit accepter tout brouillage radioélectrique subi, même si le brouillage est susceptible d'en compromettre le fonctionnement.

- For vehicles sold in the U.S.A. and Canada

<Tire Pressure Monitoring Sensor, RKE Transmitter,  
TPM/RKE Integrated Receiver>

BCS Access Systems US LLC

TPM Sensor

Model: 335098

FCC ID: GQ4-72T

IC: 1470A-53T

RKE Transmitter

Model: 336600

FCC ID: GQ4-73T

IC: 1470A-54T

Integrated Receiver

Model: 337136

FCC ID: GQ4-50R

CAN RSS-GEN/CNR-GEN

MADE IN U.S.A.

This device complies with Part 15 of the FCC Rules and with Canada license-exempt RSS standard(s). Operation is subject to the following two conditions:

- (1) This device may not cause harmful interference, and
- (2) This device must accept any interference received, including interference that may cause undesired operation.

Le present appareil est conforme aux CNR d'Industrie Canada applicable aux appareils radio exempts de licence.

L'exploitation est autorisee aux deux conditions suivantes:

- (1) L'appareil ne doit pas produire de brouillage.
- (2) L'utilisateur de l'appareil doit accepter tout brouillage radioelectrique subi, meme si le brouillage est susceptible d'en compromettre le fonctionnement.

**WARNING:** Changes or modifications not expressly approved by BCS Access Systems US LLC could void the user's authority to operate the equipment.

The term "IC:" before the radio certification

**Installing tire pressure warning valves and transmitters<sup>\*1</sup>**

<sup>\*1</sup>: Vehicles with tire pressure warning system only

When replacing tires or wheels, tire pressure warning valves and transmitters must also be installed.

- ▶ Except for models made in Japan<sup>\*2</sup> without tire inflation pressure display function

When new tire pressure warning valves and transmitters are installed, new ID codes must be registered in the tire pressure warning computer and the tire pressure warning system must be initialized. (→P.593)

<sup>\*2</sup>: The country of production is written on the Certification Regulation label. (→P.665)

- ▶ For models made in Japan<sup>\*2</sup> without tire inflation pressure display function

When new tire pressure warning valves and transmitters are installed, new ID codes must be registered in the tire pressure warning computer and the tire pressure warning system must be initialized. Have tire pressure warning valve and transmitter ID codes registered by your Toyota dealer.

<sup>\*2</sup>: The country of production is written on the Certification Regula-

tion label. (→P.665)

**When replacing the tires and wheels (vehicles with tire pressure warning system)**

If the ID code of the tire pressure warning valve and transmitter is not registered, the tire pressure warning system will not work properly. After driving for about 20 minutes, the tire pressure warning light blinks for 1 minute and stays on to indicate a system malfunction.

 NOTICE

**Repairing or replacing tires, wheels, tire pressure warning valves, transmitters and tire valve caps (vehicles with tire pressure warning system)**

- When removing or fitting the wheels, tires or the tire pressure warning valves and transmitters, contact your Toyota dealer as the tire pressure warning valves and transmitters may be damaged if not handled correctly.
- Make sure to install the tire valve caps. If the tire valve caps are not installed, water could enter the tire pressure warning valves and the tire pressure warning valves could be bound.
- When replacing tire valve caps, do not use tire valve caps other than those specified. The cap may become stuck.

### Initializing the tire pressure warning system (if equipped)

#### ■ The tire pressure warning system must be initialized in the following circumstances:

- When rotating the tires.
- When changing the tire.
- After registering the ID codes. (→P.593)

When the tire pressure warning system is initialized, the current tire inflation pressure is set as the benchmark pressure.

#### ■ How to initialize the tire pressure warning system

##### ▶ Vehicles without tire inflation pressure display function



- 1 Park the vehicle in a safe place and stop the engine.

Initialization cannot be performed while the vehicle is moving.



- 2 Adjust the tire inflation pressure to the specified cold tire inflation pressure level. (→P.671)



Make sure to adjust the tire pressure to the specified cold tire inflation pressure level. The tire pressure warning system will operate based on this pressure level.

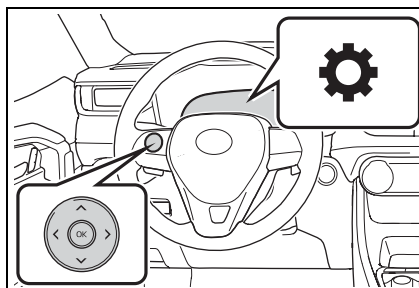

- 3 Turn the engine switch to ON.

- 4 Press  or  of the meter control switches on the steering wheel and select .



- 5 Press  or  of the meter control switches, select "Vehicle Settings" and then press .

- 6 Press  or  of the meter control switches, select "TPWS" and then press .

- 7 Press  or  of the meter control switches, select the "Set Pressure". Then press and hold .

"Setting Tire Pressure Warning System" will be displayed on the multi-information display and the tire pressure warning light will blink 3 times.

When the message disappears, initialization is complete.

##### ▶ Vehicles with tire inflation pressure display function

- 1 Park the vehicle in a safe place and stop the engine for 20 minutes or more.

Initialization cannot be performed while the vehicle is moving.



- 2 Adjust the tire inflation pressure to the specified cold tire

inflation pressure level.  
(→P.671)

Make sure to adjust the tire pressure to the specified cold tire inflation pressure level. The tire pressure warning system will operate based on this pressure level.

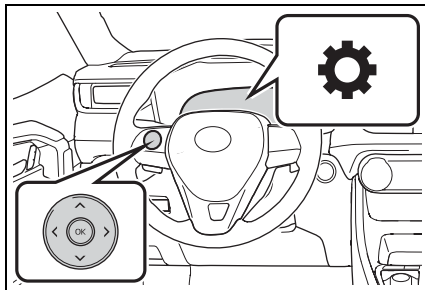
- 3 Start the engine.
- 4 Press **<** or **>** of the meter control switches on the steering wheel and select .



- 5 Press **▲** or **▼** of the meter control switches, select “Vehicle Settings” and then press .
- 6 Press **▲** or **▼** of the meter control switches, select “TPWS” and then press .
- 7 Press **▲** or **▼** of the meter control switches, select the “Set Pressure”. Then press and hold .

“Setting Tire Pressure Warning System” will be displayed on the multi-information display and the tire pressure warning light will blink 3 times.

When the message disappears, initialization is complete.

A message is displayed on the

multi-information display. Also, “--” is displayed for inflation pressure of each tire on the multi-information display while the tire pressure warning system determines the position.

- 8 Drive the vehicle at approximately 25mph (40 km/h) or more for approximately 10 to 30 minutes.

When initialization is complete, the inflation pressure of each tire will be displayed on the multi-information display.

Even if the vehicle is not driven at approximately 25 mph (40 km/h) or more, initialization can be completed by driving for a long time. However, if initialization does not complete after driving for 1 hour or more, park the vehicle in a safe place for approximately 20 minutes and then drive the vehicle again.

■ **When initializing**

- Vehicles with tire inflation pressure display function only: Initialization is performed while driving at a vehicle speed of approximately 25 mph (40 km/h) or more.
- Make sure to carry out initialization after adjusting the tire inflation pressure. Also, make sure the tires are cold before carrying out initialization or tire inflation pressure adjustment.
- Vehicles with tire inflation pressure display function only: The tire pressure warning system can be initialized by yourself, but depending on the driving conditions and driving environment, initialization may take some time to complete.

■ **The initialization operation**

- If you have accidentally turned the engine switch to OFF during initialization, it is not necessary to restart the initialization again as initialization will restart automati-

cally when the engine switch has been turned to ON for the next time.

- If you accidentally perform the initialization when initialization is not necessary, adjust the tire inflation pressure to the specified level when the tires are cold, and conduct initialization again.
- Vehicles with tire inflation pressure display function only: While the position of each tire is being determined and the inflation pressures are not being displayed on the multi-information display, if the inflation pressure of a tire drops, the tire pressure warning light will come on.

■ **When initialization of the tire pressure warning system has failed (vehicles without tire inflation pressure display function)**

Initialization can be completed in a few minutes. However, in the following cases, the settings have not been recorded and the system will not operate properly. If repeated attempts to record tire inflation pressure settings are unsuccessful, have the vehicle inspected by your Toyota dealer.

- When operating the tire pressure warning reset switch, the tire pressure warning light does not blink 3 times.
- After driving for a certain period of time since the initialization has been completed, the warning light comes on after blinking for 1 minute.

■ **If the tire pressure warning system is not initialized properly (vehicles with tire inflation pressure display function)**

In the following situations, initialization may take longer than usual to be completed or may not be possible. Normally, initialization completes within approximately 30 minutes.

- Vehicle is not driven at approximately 25 mph (40 km/h) or more
- Vehicle is driven on unpaved roads
- Vehicle is driven near other vehicles and system cannot recognize tire pressure warning valve and transmitters of your vehicle over those of other vehicles.

If initialization does not complete after driving for 1 hour or more, park the vehicle in a safe place for approximately 20 minutes and then drive the vehicle again.

- If the vehicle is reversed during initialization, the data up to that point is reset, so perform the initialization procedure again from the beginning.
- In the following situations, initialization will not be started or was not completed properly and the system will not operate properly. Perform the initialization procedure again.
  - If, when attempting to start initialization, the tire pressure warning light does not blink 3 times.
  - If, when the vehicle has been driven for about 20 minutes after performing initialization, the tire pressure warning light blinks for approximately 1 minute and then illuminates.

If the inflation pressure of each tire is still not displayed, have the vehicle inspected by your Toyota dealer.



**⚠ WARNING****■ When initializing the tire pressure warning system**

Do not initialize tire inflation pressure without first adjusting the tire inflation pressure to the specified level. Otherwise, the tire pressure warning light may not come on even if the tire inflation pressure is low, or it may come on when the tire inflation pressure is actually normal.

**Registering ID codes (vehicles with tire pressure warning system)**

- ▶ For models made in Japan<sup>\*1</sup> without tire inflation pressure display function

Every tire pressure warning valve and transmitter has a unique ID code. In addition to the set of tire pressure warning system sensor ID codes initially registered to the vehicle, a second set of ID codes can be registered. A second set of tire pressure warning system sensor ID codes can be registered at your Toyota dealer. When 2 sets of ID codes have been registered, either ID code set can be selected.

<sup>\*1</sup>: The country of production is written on the Certification Regulation label. (→P.665)













- ▶ Except for models made in Japan<sup>\*2</sup> without tire inflation pressure display function

<sup>\*2</sup>: The country of production is written

on the Certification Regulation label. (→P.665)

Every tire pressure warning valve and transmitter has a unique ID code. When replacing a tire pressure warning valve and transmitter, it is necessary to register the ID code.

When registering the ID codes, perform the following procedure.

- 1 Park the vehicle in a safe place, wait for approximately 20 minutes, and then start the engine.
- 2 Press  or  of the meter control switches on the steering wheel and select .
- 3 Press  or  of the meter control switches and select "Vehicle Settings", and then press .
- 4 Press  or  of the meter control switches and select "TPWS", and then press .
- 5 Press  or  of the meter control switches and select "Change Wheel". Then press and hold  until the tire pressure warning light starts slowly blinking 3 times.

The change wheel set mode is activated and registration is started.

Vehicles with a tire inflation pressure display function only: Then a message will be displayed on the multi-information display. When registration is being performed, the tire pressure warning light will blink

for approximately 1 minute then illuminate and "--" will be displayed for the inflation pressure of each tire on the multi-information display.

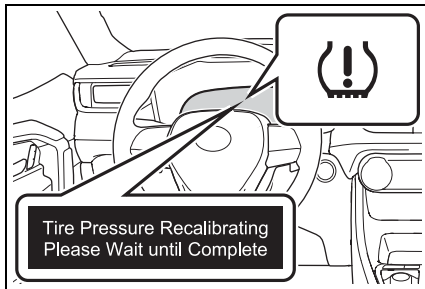

- 6 Drive the vehicle at approximately 25mph (40 km/h) or more for approximately 10 to 30 minutes.

When registration is completed, the tire pressure warning light will go off and the inflation pressure of each tire will be displayed on the multi-information display.

Even if the vehicle is not driven at approximately 25 mph (40 km/h) or more, registration can be completed by driving for a long time. However, if registration does not complete after driving for 1 hour or more, perform the procedure again from the beginning.

- 7 Initialize the tire pressure warning system. (→P.590)

#### ■ When registering ID codes

- ID code registration is performed while driving at a vehicle speed of approximately 25 mph (40 km/h) or more.
- Before performing ID code registration, make sure that no wheels with tire pressure warning valve and transmitters installed are near the vehicle.
- Make sure to initialize the tire pressure warning system after registering the ID codes. If the

system is initialized before registering the ID codes, the initialized values will be invalid.

- ID codes can be registered by yourself, but depending on the driving conditions and driving environment, registration may take some time to complete.

#### ■ Canceling ID code registration

- To cancel ID code registration after it has been started, turn the engine switch off before driving the vehicle. If the vehicle is driven after ID code registration is started, to cancel registration, perform the ID code registration start procedure again and turn the engine switch off before driving.
- If ID code registration has been canceled, the tire pressure warning light will blink for approximately 1 minute when the engine switch is turned to ON and then illuminate. The tire pressure warning system will be operational when the tire pressure warning light turns off.
- If the warning light does not turn off even after several minutes have elapsed, ID code registration may not have been canceled correctly. To cancel registration, perform the ID code registration start procedure again and then turn the engine switch off before driving.

#### ■ If ID codes are not registered properly

In the following situations, ID code registration may take longer than usual to be completed or may not be possible. Normally, registration completes within approximately 30 minutes.

- Vehicle is not parked for approximately 20 minutes or more before driving
- Vehicle is not driven at approximately 25 mph (40 km/h) or more
- Vehicle is driven on unpaved roads

- Vehicle is driven near other vehicles and system cannot recognize tire pressure warning valve and transmitters of your vehicle over those of other vehicles
- Wheel with tire pressure warning valve and transmitter installed is inside or near the vehicle

If registration does not complete after driving for 1 hour or more, perform the ID code registration procedure again from the beginning.

- If the vehicle is reversed during registration, the data up to that point is reset, so perform the registration procedure again from the beginning.
- In the following situations, ID code registration will not be started or was not completed properly and the system will not operate properly. Perform the ID code registration procedure again.
  - If, when attempting to start ID code registration, the tire pressure warning light does not blink slowly 3 times.
  - If, when the vehicle has been driven for about 20 minutes after performing ID code registration, the tire pressure warning light blinks for approximately 1 minute and then illuminates.

If the ID codes cannot be registered even when performing the above procedure, contact your Toyota dealer.

### Tire inflation pressure

**Make sure to maintain the proper tire inflation pressure. Tire inflation pressure should be checked at least once per month. However, Toyota recommends that tire inflation pressure be checked once every two weeks. (→P.671)**

### Checking the specified tire inflation pressure

The recommended cold tire inflation pressure and tire size are displayed on the tire and loading information label. (→P.671)

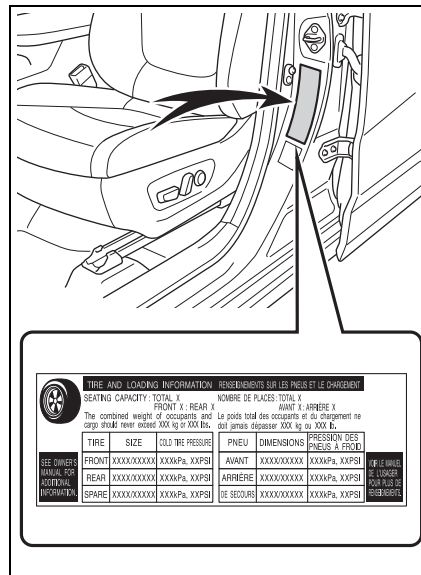

### Inspection and adjustment procedure

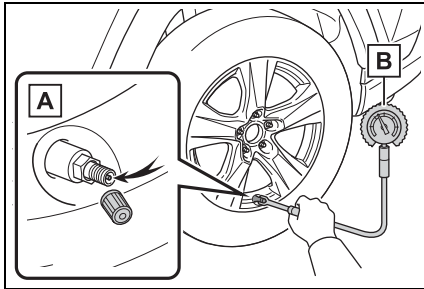

**A** Tire valve

**B** Tire pressure gauge

- 1 Remove the tire valve cap.
- 2 Press the tip of the tire pressure gauge onto the tire valve.
- 3 Read the pressure using the gauge gradations.
- 4 If the tire inflation pressure is not at the recommended level, adjust the pressure. If you add too much air, press the center of the valve to deflate.
- 5 After completing the tire inflation pressure measurement and adjustment, apply soapy water to the valve and check for leakage.
- 6 Put the tire valve cap back on.

#### ■ Tire inflation pressure check interval

You should check tire inflation pressure every two weeks, or at least once a month.

Do not forget to check the spare.

#### ■ Effects of incorrect tire inflation pressure

Driving with incorrect tire inflation pressure may result in the following:

- Reduced fuel economy
- Reduced driving comfort and poor handling
- Reduced tire life due to wear
- Reduced safety
- Damage to the drive train

If a tire needs frequent inflating, have it checked by your Toyota dealer.

#### ■ Instructions for checking tire inflation pressure

When checking tire inflation pressure, observe the following:

- Check only when the tires are cold.  
If your vehicle has been parked for at least 3 hours or has not been driven for more than 1 mile or 1.5 km, you will get an accurate cold tire inflation pressure reading.
- Always use a tire pressure gauge. It is difficult to judge if a tire is properly inflated based only on its appearance.
- It is normal for the tire inflation pressure to be higher after driving as heat is generated in the tire. Do not reduce tire inflation pressure after driving.
- Never exceed the vehicle capacity weight. Passengers and luggage weight should be placed so that the vehicle is balanced.

**⚠ WARNING****■ Proper inflation is critical to save tire performance**

Keep your tires properly inflated. If the tires are not properly inflated, the following conditions may occur which could lead to an accident resulting in death or serious injury:

- Excessive wear
- Uneven wear
- Poor handling
- Possibility of blowouts resulting from overheated tires
- Air leaking from between tire and wheel
- Wheel deformation and/or tire damage
- Greater possibility of tire damage while driving (due to road hazards, expansion joints, sharp edges in the road, etc.)

**⚠ NOTICE****■ When inspecting and adjusting tire inflation pressure**

Be sure to put the tire valve caps back on. If a valve cap is not installed, dirt or moisture may get into the valve and cause an air leak, resulting in decreased tire inflation pressure.

**Wheels**

**If a wheel is bent, cracked or heavily corroded, it should be replaced. Otherwise, the tire may separate from the wheel or cause a loss of handling control.**

**Wheel selection**

When replacing wheels, care should be taken to ensure that they are equivalent to those removed in load capacity, diameter, rim width and inset\*.

Replacement wheels are available at your Toyota dealer.

\*: Conventionally referred to as offset.

Toyota does not recommend using the following:

- Wheels of different sizes or types
- Used wheels
- Bent wheels that have been straightened

**■ When replacing wheels (vehicles with tire pressure warning system)**

The wheels of your vehicle are equipped with tire pressure warning valves and transmitters that allow the tire pressure warning system to provide advance warning in the event of a loss in tire inflation pressure. Whenever wheels are replaced, tire pressure warning valves and transmitters must be installed. (→P.584, 598)

**⚠ WARNING****■ When replacing wheels**

- Do not use wheels that are a different size from those recommended in the Owner's Manual, as this may result in a loss of handling control.
- Never use an inner tube in a leaking wheel which is designed for a tubeless tire. Doing so may result in an accident, causing death or serious injury.

**■ When installing the wheel nuts**

- Be sure to install the wheel nuts with the tapered ends facing inward. (→P.647) Installing the nuts with the tapered ends facing outward can cause the wheel to break and eventually cause the wheel to come off while driving, which could lead to an accident resulting in death or serious injury.
- Never use oil or grease on the wheel bolts or wheel nuts. Oil and grease may cause the wheel nuts to be excessively tightened, leading to bolt or disc wheel damage. In addition, the oil or grease can cause the wheel nuts to loosen and the wheel may fall off, causing an accident and resulting in death or serious injury. Remove any oil or grease from the wheel bolts or wheel nuts.

**■ Use of defective wheels prohibited**

Do not use cracked or deformed wheels.

Doing so could cause the tire to leak air during driving, possibly causing an accident.

**⚠ NOTICE****■ Replacing tire pressure warning valves and transmitters (vehicles with tire pressure warning system)**

- Because tire repair or replacement may affect the tire pressure warning valves and transmitters, make sure to have tires serviced by your Toyota dealer or other qualified service shop. In addition, make sure to purchase your tire pressure warning valves and transmitters at your Toyota dealer.
- Ensure that only genuine Toyota wheels are used on your vehicle. Tire pressure warning valves and transmitters may not work properly with non-genuine wheels.

**Aluminum wheel precautions**

- Use only Toyota wheel nuts and wrenches designed for use with your aluminum wheels.
- When rotating, repairing or changing your tires, check that the wheel nuts are still tight after driving 1000 miles (1600 km).
- Be careful not to damage the aluminum wheels when using tire chains.
- Use only Toyota genuine balance weights or equivalent and a plastic or rubber hammer when balancing your wheels.

**Air conditioning filter**

**The air conditioning filter must be changed regularly to maintain air conditioning efficiency.**

**Removal method**

- 1 Turn the engine switch off.
- 2 Open the glove box and slide off the damper.

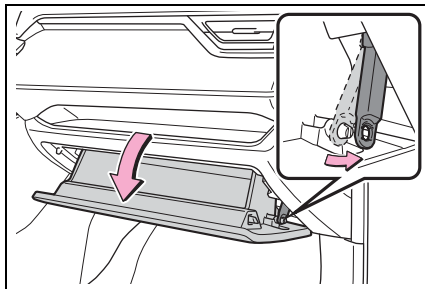

- 3 Push in each side of the glove box to disconnect the claws, and then slowly and fully open the glove box while supporting it.

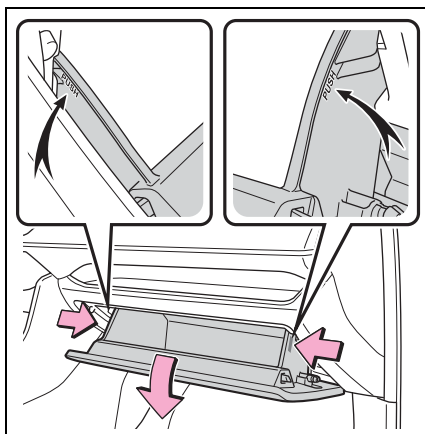

- 4 With the glove box fully open, slightly lift up the glove box and pull toward the seat to detach the bottom of the glove box.

Do not use excessive force if the glove box does not detach when lightly pulled. Instead, pull toward the seat while slightly adjusting the height of the glove box.

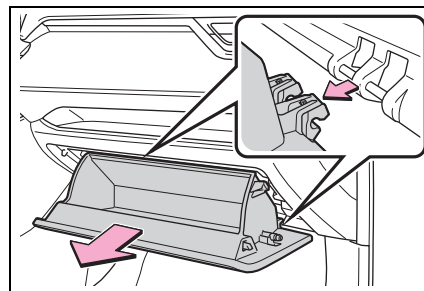

- 5 Unlock the filter cover (A), pull the filter cover out of the claws (B), and remove the filter cover.

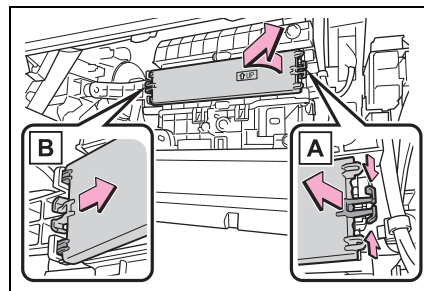

6 Remove the filter case.

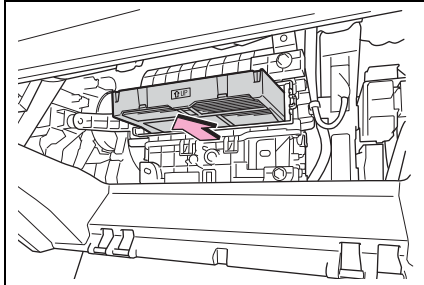

7 Remove the air conditioning filter from the filter case and replace it with a new one.

The “↑ UP” marks shown on the filter should be pointing up.

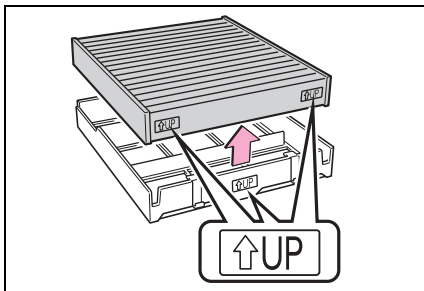

8 When installing, reverse the steps listed.

■ **Checking interval**

Inspect and replace the air conditioning filter according to the maintenance schedule. In dusty areas or areas with heavy traffic flow, early replacement may be required. (For scheduled maintenance information, please refer to the “Owner’s Manual Supplement” or “Scheduled Maintenance”.)

■ **If air flow from the vents decreases dramatically**

The filter may be clogged. Check the filter and replace if necessary.

 **NOTICE**

■ **When using the air conditioning system**

Make sure that a filter is always installed.

Using the air conditioning system without a filter may cause damage to the system.

■ **When removing the glove box**

Always follow the specified procedure to remove the glove box (→P.599). If the glove box is removed without following the specified procedure, the hinge of the glove box may become damaged.

■ **To prevent damage to the filter cover**

When moving the filter cover in the direction of arrow to release the fitting, pay attention not to apply excessive force to the claws. Otherwise, the claws may be damaged.

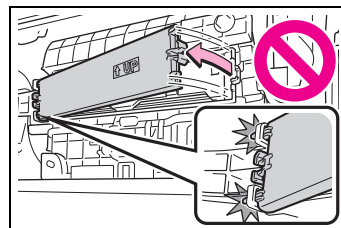



**Wiper insert replacement**

**When replacing the wiper insert, perform the following procedure to operate each wiper.**

**Windshield wipers**

**Windshield wiper blade removal and installation**

- 1 While holding the hook portion **A** of the wiper arm, first lift up the driver side, and then lift up the passenger side.

When returning the wiper arms to their original positions, first lower the passenger side, and then lower the driver side.

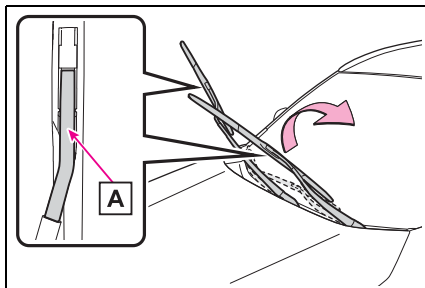

- 2 Lift the stopper using a flat-head screwdriver as shown in the illustration.

To prevent damage to the wiper arm, protect the tip of the screw-

driver with a rag.

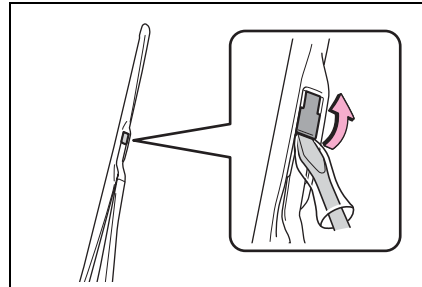

- 3 Slide the wiper blade to remove it from the wiper arm.

When installing, reverse the steps listed.

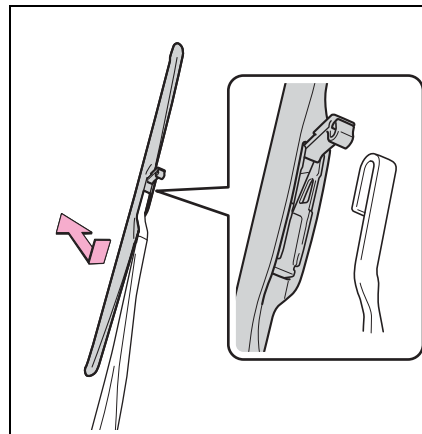

**Wiper insert replacement**

- 1 Pull the wiper insert to remove the claw of the wiper blade from the stopper, and pull out the wiper insert.

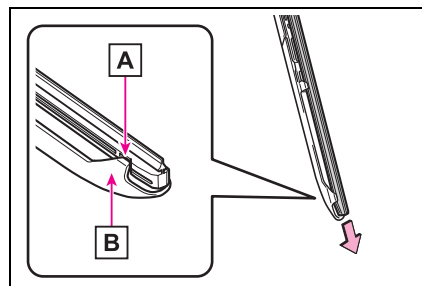

**A** Stopper

**B** Claw

- Remove the 2 metal plates from the wiper insert pulled out, and install the plates to a new wiper insert.

Make sure that the cutout location and warp direction of the metal blades are same as the original.

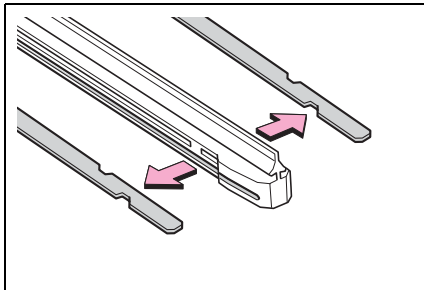

- Install the wiper insert to the wiper blade from the side without the stopper.
- Secure the stopper of the wiper insert with the claw of the wiper blade.

**Rear window wiper**

- Lift up the rear window wiper arm head cap.

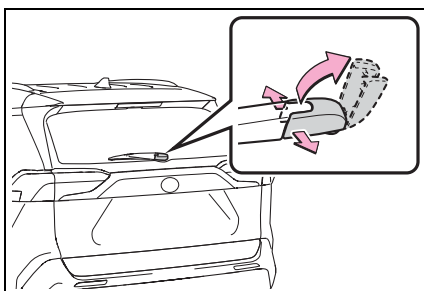

- Move the wiper blade until a click sound can be heard and

the claw detaches, and then remove the wiper blade from the wiper arm.

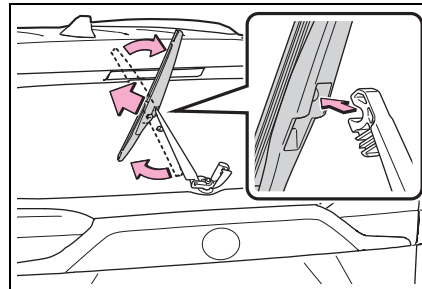

- Pull the wiper insert out past the stopper on the wiper blade, and then continue to pull until it is completely removed.

Lightly grasp between the claws of the wiper blade to allow the wiper insert to lift up, making it easier to remove.

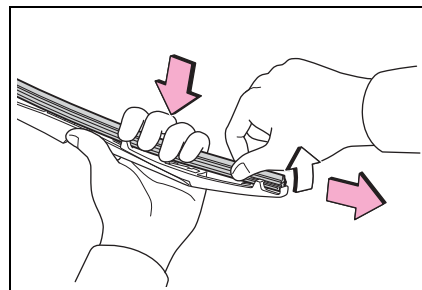

- Remove the 2 metal plates from the old wiper insert and

install them to the replacement wiper insert.

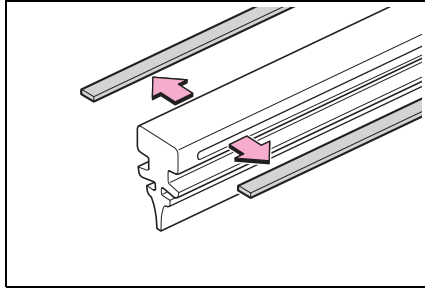

- 5 Insert the wiper insert starting from the claw at the center of the wiper blade. Pass the wiper insert through the 3 claws so that it sticks out from the stopper, and then pass the wiper insert through the final remaining claw.

Applying a small amount of washer fluid to the wiper insert can make it easier to insert the claws into the grooves.

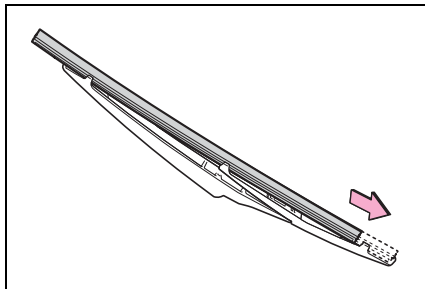

- 6 Check that the wiper blade claws are fitted in the grooves of the wiper insert.

If the wiper blade claws are not fitted in the grooves of the wiper insert, grasp the wiper insert and slide it back and forth multiple times to insert the claws into the grooves.

Lightly lift up the center of the wiper insert to make the rubber easier to

slide.

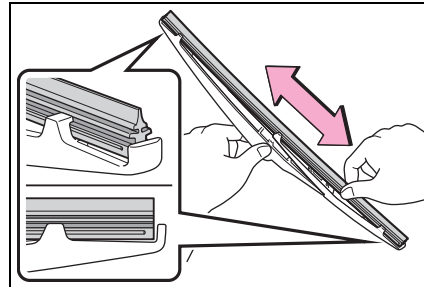

- 7 When installing a wiper blade, reverse the procedure in step 1.

After installing the wiper blade, check that the connection is locked.

#### ■ Wiper blade and wiper insert handling

Improper handling may result in damage to the wiper blades or wiper insert. If you have any concerns about replacing the wiper blades or wiper insert yourself, contact your Toyota dealer.

#### ⚠ NOTICE

##### ■ When lifting the windshield wipers

- When raising the wiper arms off the windshield, lift up the driver side first, and then lift up passenger side. When returning the wipers to their original position, return the passenger side first.
- Do not lift a windshield wiper by the wiper blade. Otherwise, the wiper blade may be deformed.
- Do not operate the wiper lever when the windshield wipers are lifted. Otherwise, the windshield wipers may contact the hood, possibly resulting in damage to the windshield wipers and/or hood.

**NOTICE****■ To prevent damage**

- Be careful not to damage the claws when replacing the wiper insert.
- After the wiper blade is removed from the wiper arm, place a cloth, etc., between the rear window and wiper arm to prevent damage to the rear window.
- Be sure not to pull excessively on the wiper insert or deform its metal plates.

**Wireless remote control/electronic key battery****Replace the battery with a new one if it is depleted.****■ If the key battery is depleted**

The following symptoms may occur:

- The smart key system (if equipped) and wireless remote control will not function properly.
- The operational range will be reduced.

**Items to prepare**

Prepare the following before replacing the battery:

- Flathead screwdriver
- Small flathead screwdriver
- Lithium battery CR2032

**■ Use a CR2032 lithium battery**

- Batteries can be purchased at your Toyota dealer, local electrical appliance shops or camera stores.
- Replace only with the same or equivalent type recommended by the manufacturer.
- Dispose of used batteries according to the local laws.

**Replacing the battery**

- ▶ Vehicles without smart key system

- 1 Remove the cover.

Use a screwdriver of an appropriate size. Forcedly prying may cause the cover damaged.

To prevent damage to the key, cover the tip of the screwdriver with a rag.

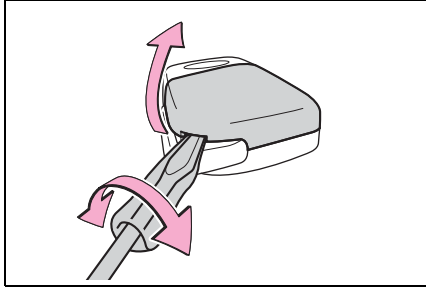

2 Remove the battery cover.

If the battery cover is difficult to remove, lift the edge to remove it.

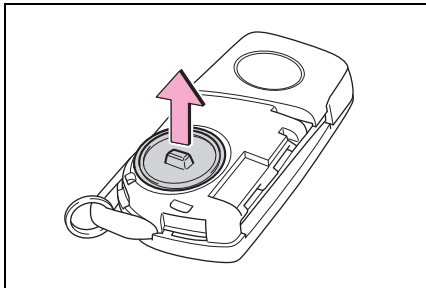

3 Remove the depleted battery.

When removing the battery, use a screwdriver of an appropriate size. Insert a new battery with the “+” terminal facing up.

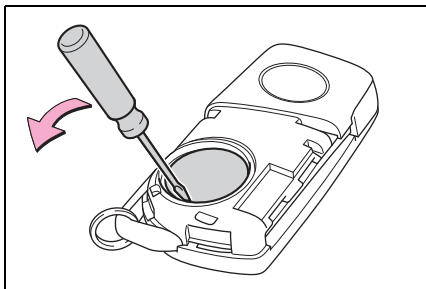

4 Install the battery cover with the tab facing up.

Push the entire edge of the battery

cover into the key.

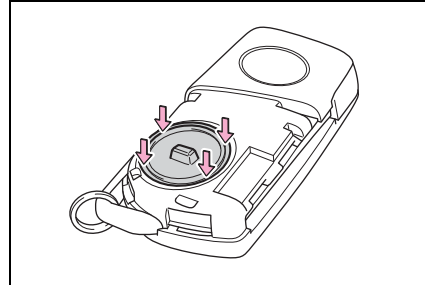

5 Install the key cover.

Align the key cover with the key and then press it straight into the key.

Make sure that the key cover is securely installed without any gaps between it and the key.

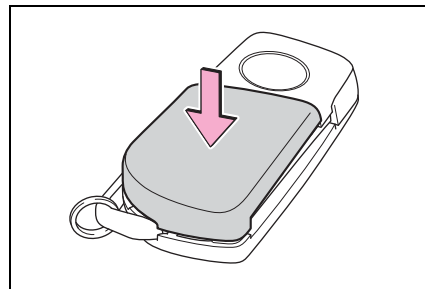

► Vehicles with smart key system

1 Release the lock and remove the mechanical key.

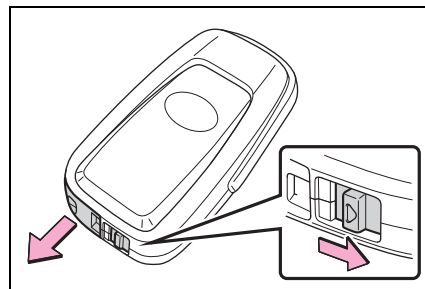

2 Remove the key cover.

Use a screwdriver of an appropriate size. Forcedly prying may cause

the cover damaged.

To prevent damage to the key, cover the tip of the flathead screwdriver with a rag.

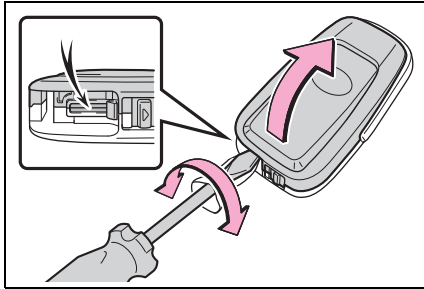

- 3 Remove the depleted battery using a small flathead screwdriver.

When removing the cover, the electronic key module may stick to the cover and the battery may not be visible. In this case, remove the electronic key module in order to remove the battery.

When removing the battery, use a screwdriver of an appropriate size.

Insert a new battery with the “+” terminal facing up.

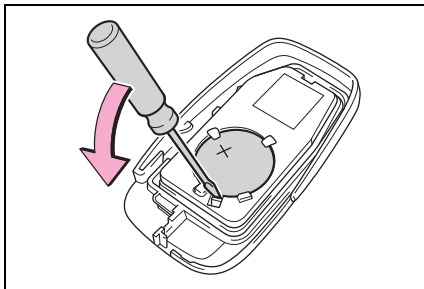

- 4 When installing, reverse the steps listed.

**⚠ WARNING**

**■ Removed battery and other parts**

These parts are small and if swallowed by a child, they can cause choking. Keep away from children. Failure to do so could result in death or serious injury.

**⚠ NOTICE**

**■ For normal operation after replacing the battery**

Observe the following precautions to prevent accidents:

- Always work with dry hands. Moisture may cause the battery to rust.
- Do not touch or move any other component inside the remote control.
- Do not bend either of the battery terminals.

**Checking and replacing fuses**

**If any of the electrical components do not operate, a fuse may have blown. If this happens, check and replace the fuses as necessary.**

**Checking and replacing fuses**

- 1 Turn the engine switch off.
- 2 Open the fuse box cover.
  - ▶ Engine compartment: Type A fuse box (if equipped)

Push claw **A** and **B** to completely release the lock, and then lift up the cover.

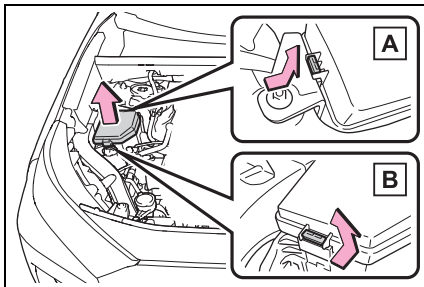

- ▶ Engine compartment: Type B fuse box

Push claw **A** and **B** to completely release the lock, and then lift up the cover.

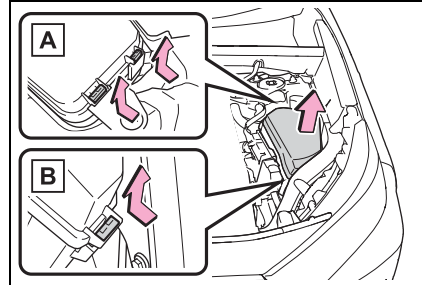

- ▶ Left side instrument panel

Remove the lid.

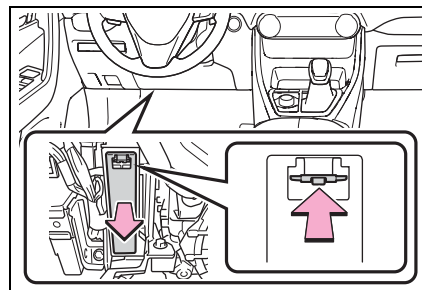

- 3 Remove the fuse.

Only type A fuse can be removed using the pullout tool.

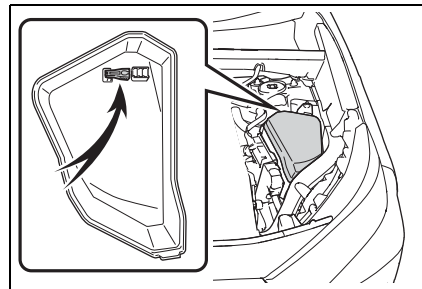

- 4 Check if the fuse is blown.

Replace the blown fuse with a new fuse of an appropriate amperage rating. The amperage rating can be found on the fuse box lid.

► Type A

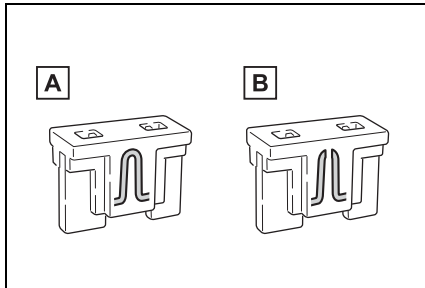

**A** Normal fuse

**B** Blown fuse

► Type B

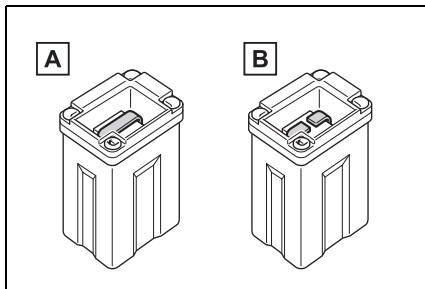

**A** Normal fuse

**B** Blown fuse

► Type C

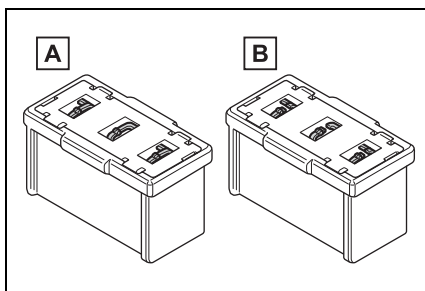

**A** Normal fuse

**B** Blown fuse

■ **After a fuse is replaced**

- When installing the lid, make sure that the tab is installed securely.
- If the lights do not turn on even after the fuse has been replaced, a bulb may need replacement. (→P.609)
- If the replaced fuse blows again, have the vehicle inspected by your Toyota dealer.

■ **If there is an overload in a circuit**

The fuses are designed to blow, protecting the wiring harness from damage.

**⚠ WARNING**

■ **To prevent system breakdowns and vehicle fire**

Observe the following precautions. Failure to do so may cause damage to the vehicle, and possibly a fire or injury.

- Never use a fuse of a higher amperage rating than that indicated, or use any other object in place of a fuse.
- Always use a genuine Toyota fuse or equivalent. Never replace a fuse with a wire, even as a temporary fix.
- Do not modify the fuses or fuse boxes.

**⚠ NOTICE**

■ **Before replacing fuses**

Have the cause of electrical overload determined and repaired by your Toyota dealer as soon as possible.



 NOTICE

■ **To prevent damage to the engine compartment fuse box cover**

When opening the fuse box, completely release the claw locks before lifting up the cover. Otherwise, the claws may be damaged.

**Light bulbs**

**You may replace the following bulbs by yourself. The difficulty level of replacement varies depending on the bulb. If necessary bulb replacement seems difficult to perform, contact your Toyota dealer.**

**For more information about replacing other light bulbs, contact your Toyota dealer.**

**Preparing for light bulb replacement**

Check the wattage of the light bulb to be replaced. (→P.675)

**Bulb location**

► Front (type A)

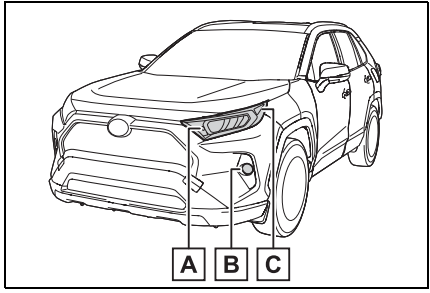

- A** Front turn signal/parking lights
- B** Fog lights (if equipped)
- C** Front side marker lights

► Front (type B)

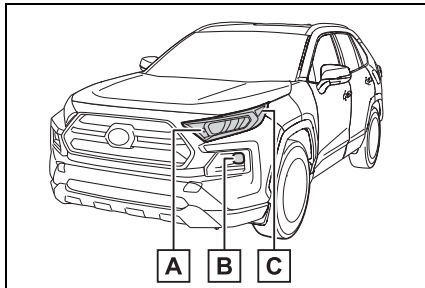

**A** Front turn signal/parking lights

**B** Fog lights

**C** Front side marker lights

► Rear

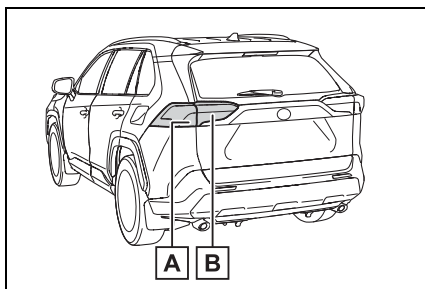

**A** Rear turn signal lights

**B** Back-up lights

■ **Lights that need to be replaced by your Toyota dealer**

- Headlights
- Daytime running lights
- Side turn signal lights (if equipped)
- Tail lights
- Stop lights
- Rear side marker lights

- High mounted stoplight
- License plate lights
- Outer foot lights (if equipped)

■ **LED lights**

The lights other than the following lights each consist of a number of LEDs. If any of the LEDs burn out, take your vehicle to your Toyota dealer to have the light replaced.

- Front turn signal lights
- Parking lights
- Front side marker lights
- Fog lights (if equipped)
- Rear turn signal lights
- Back-up lights

■ **Condensation build-up on the inside of the lens**

Temporary condensation build-up on the inside of the light lens does not indicate a malfunction. Contact your Toyota dealer for more information in the following situations:

- Large drops of water have built up on the inside of the lens.
- Water has built up inside the light.

**Replacing light bulb**

■ **Front turn signal lights/parking lights**

- 1 Turn the bulb base counter-clockwise.

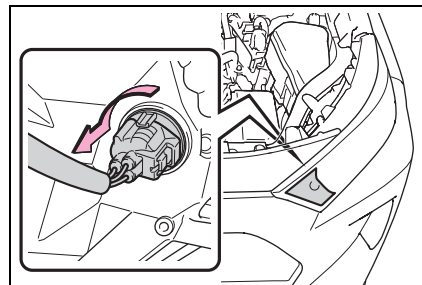

2 Remove the light bulb.

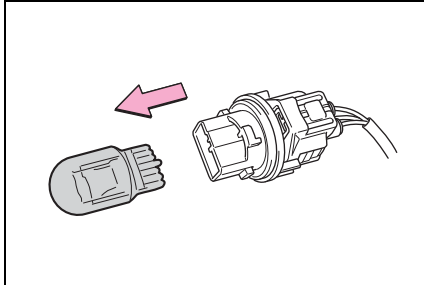

3 Install a new light bulb then install the bulb base to the light unit by inserting it and turning the bulb base clockwise.

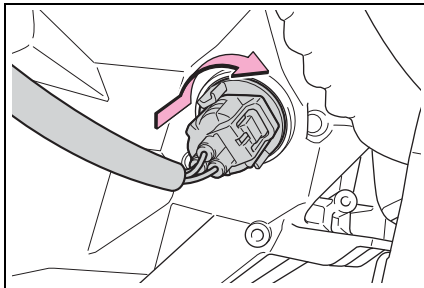

■ **Front side marker lights**

1 Turn the bulb base counter-clockwise.

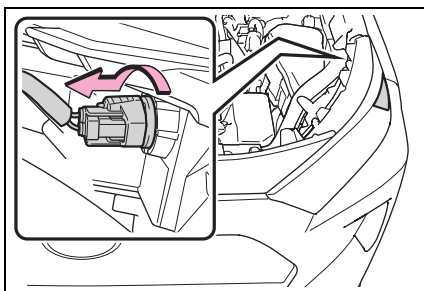

2 Remove the light bulb.

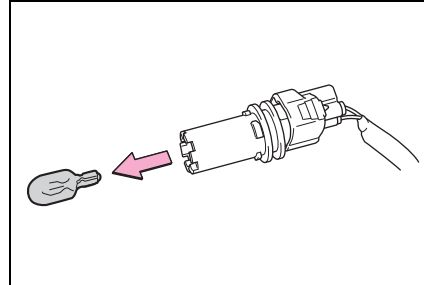

3 Install a new light bulb then install the bulb base to the light unit by inserting it and turning the bulb base clockwise.

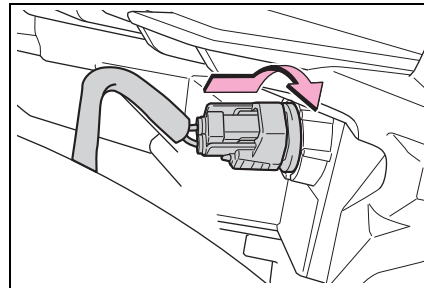

■ **Fog lights (if equipped)**

1 To allow enough working space, turn the steering wheel.

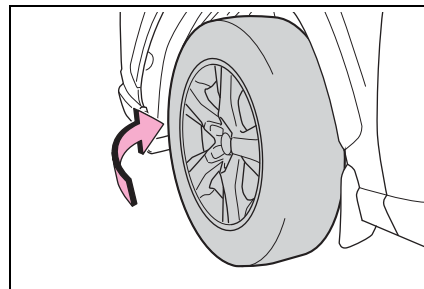

2 Remove the screws.

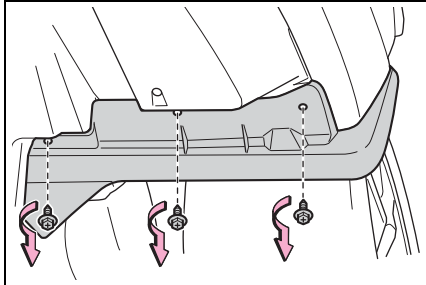

3 Remove the screws and clips, partly remove the fender liner.

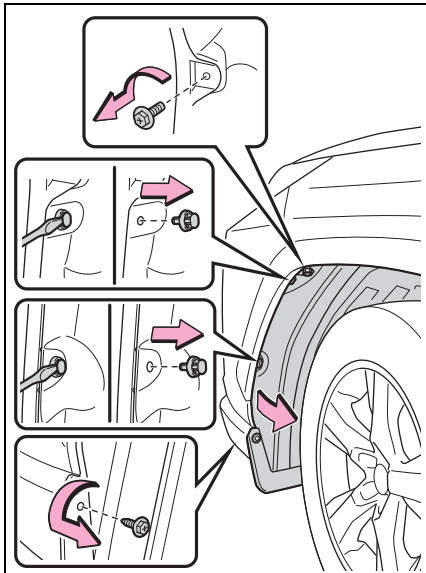

4 Unplug the connector

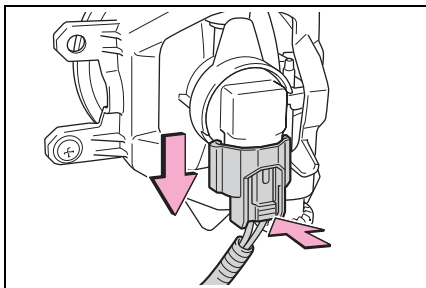

5 Turn the bulb base counter-clockwise.

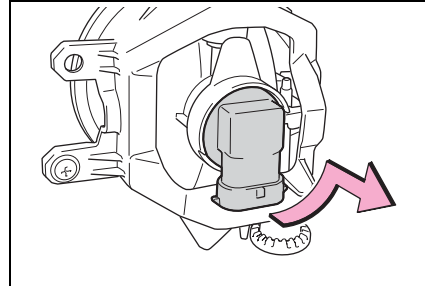

6 Set the new light bulb.

Align the 3 tabs on the light bulb with the mounting, and insert. Turn it clockwise to set.

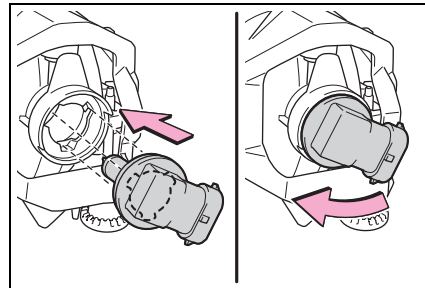

7 Set the connector.

Shake the bulb base gently to check that it is not loose, turn the front fog lights on once and visually confirm that no light is leaking through the mounting.

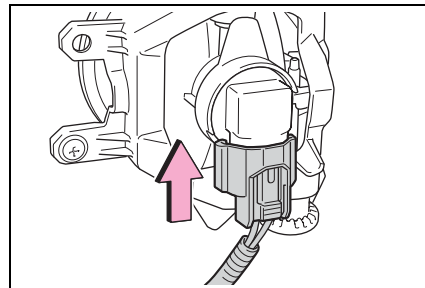

8 Reinstall the fender liner.

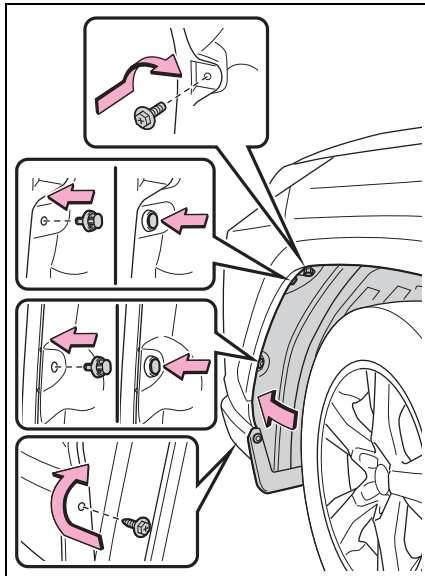

9 Reinstall the screws.

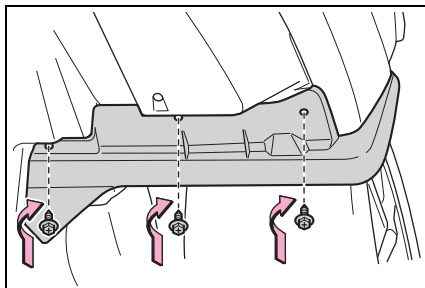

■ Rear turn signal lights

1 Open the back door and remove the cover.

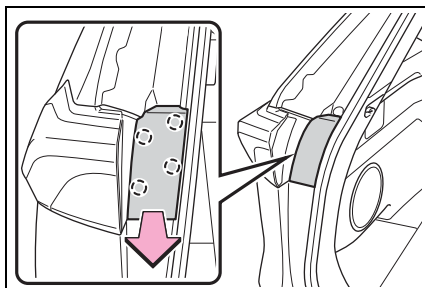

2 Remove the securing screws and remove the unit.

Remove the lamp assembly by pulling it directly backward from the rear of the vehicle.

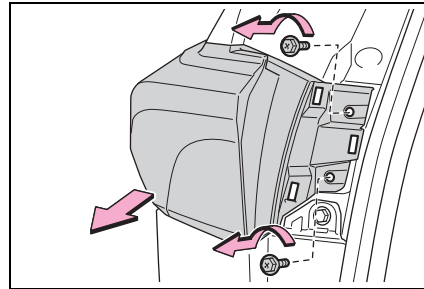

3 Turn the bulb base counter-clockwise.

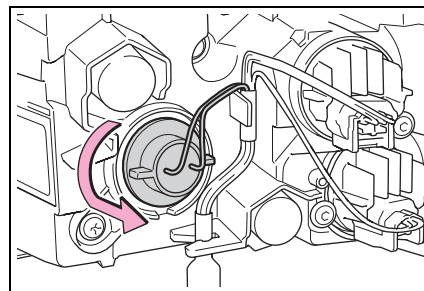

4 Remove the light bulb.

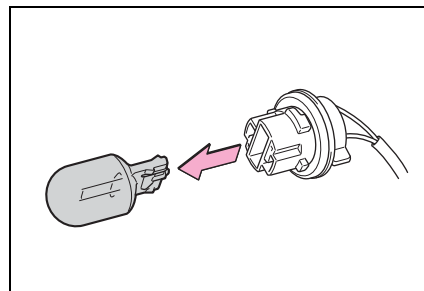

5 Install a new light bulb then install the bulb base to the light unit by inserting it and

turning the bulb base clock-wise.

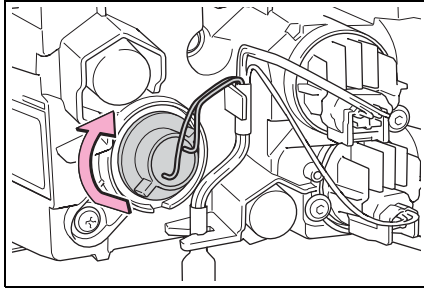

- 6 Align the grooves on the light unit with the claws, and insert the light unit straight so that the pin on the light unit fit into the hole.

Confirm that the light unit is completely secured.

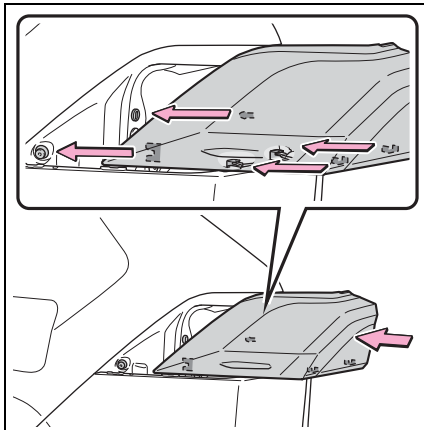

- 7 Reinstall the screws.

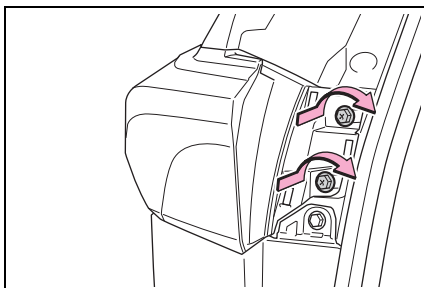

- 8 Reinstall the cover.

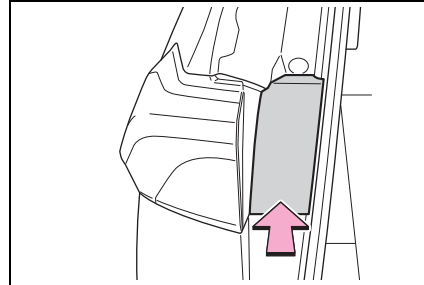

#### ■ Back-up lights

- 1 Open the back door and remove the cover.

To prevent damage to the cover, protect the tip of the screwdriver with a rag.

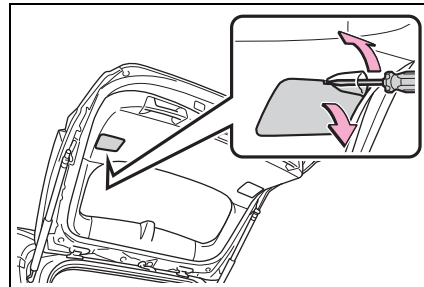

- 2 Turn the bulb base counter-clockwise.

Remove the cord from the clip

before turning the bulb base.

again after installing the bulb base.

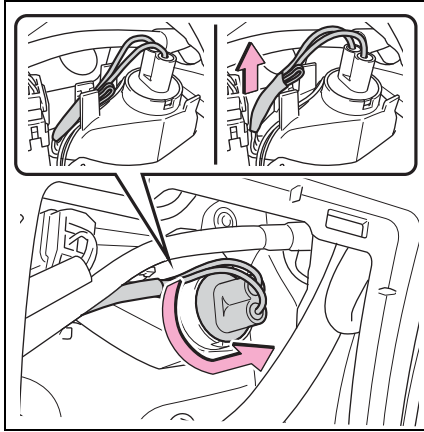

3 Remove the light bulb.

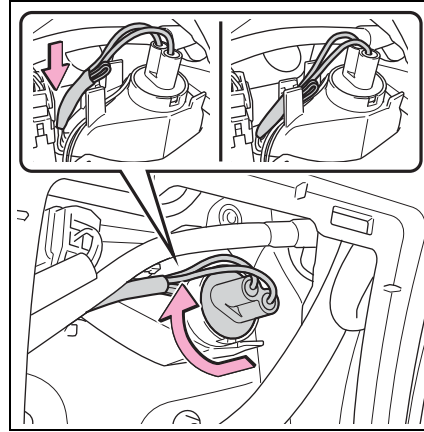

6 Reinstall the cover.

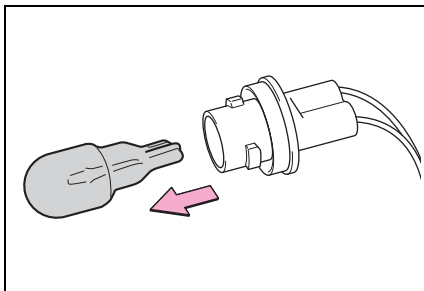

4 Install a new light bulb.

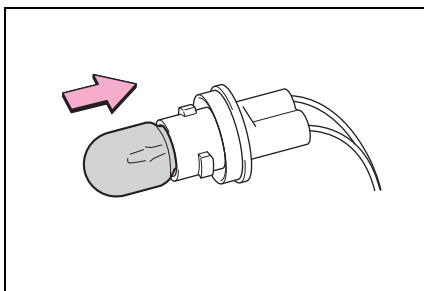
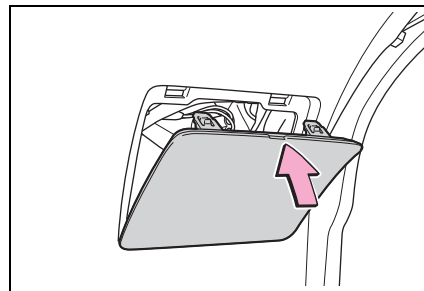

5 Install the bulb base to the light unit by inserting it and turning the bulb base clockwise.

Secure the cord with the clip back

**⚠ WARNING**

**■ Replacing light bulb**

- Turn off the light. Do not attempt to replace the bulb immediately after turning off the light. The bulb become very hot and may cause burns.
- Do not touch the glass portion of the light bulb with bare hands. When it is unavoidable to hold the glass portion, use and hold with a clean dry cloth to avoid getting moisture and oils on the bulb. Also, if the bulb is scratched or dropped, it may blow out or crack.



**WARNING**

- Fully install light bulb and any parts used to secure it. Failure to do so may result in heat damage, fire, or water entering the light unit. This may damage the light or cause condensation to build up on the lens.
  
- Do not attempt to repair or disassemble light bulbs, connectors, electric circuits or component parts.  
Doing so may result in death or serious injury due to electric shock.
  
- **To prevent damage or fire**
- Make sure bulb is fully seated and locked.
  
- Check the wattage of the bulb before installing to prevent heat damage.



**When trouble arises****8****8-1. Essential information**

Emergency flashers .... 618

If your vehicle has to be stopped in an emergency ..... 618

If the vehicle is trapped in rising water..... 619

**8-2. Steps to take in an emergency**

If your vehicle needs to be towed..... 621

If you think something is wrong ..... 626

Fuel pump shut off system ..... 627

If a warning light turns on or a warning buzzer sounds ..... 628

If a warning message is displayed..... 639

If you have a flat tire.... 642

If the engine will not start ..... 651

If you lose your keys ... 653

If the electronic key does not operate properly (vehicles with smart key system)..... 653

If the vehicle battery is discharged ..... 655

If your vehicle overheats ..... 659

If the vehicle becomes stuck ..... 661

### Emergency flashers

The emergency flashers are used to warn other drivers when the vehicle has to be stopped in the road due to a breakdown, etc.

### Operating instructions

Press the switch.

All the turn signal lights will flash.

To turn them off, press the switch once again.

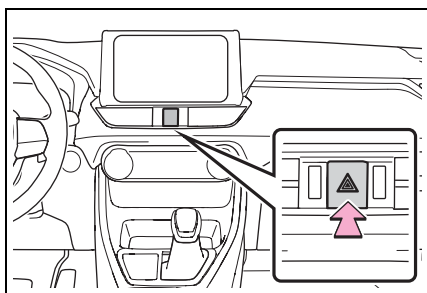

### Emergency flashers

- If the emergency flashers are used for a long time while the engine is not running, the battery may discharge.
- If any of the SRS airbags deploy (inflate) or in the event of a strong rear impact, the emergency flashers will turn on automatically. The emergency flashers will turn off automatically after operating for approximately 20 minutes. To manually turn the emergency flashers off, press the switch twice. (The emergency flashers may not turn on automatically depending on the force of the impact and conditions of the collision.)

If your vehicle has to be stopped in an emergency

Only in an emergency, such as if it becomes impossible to stop the vehicle in the normal way, stop the vehicle using the following procedure:

### Stopping the vehicle

- 1 Steadily step on the brake pedal with both feet and firmly depress it.

Do not pump the brake pedal repeatedly as this will increase the effort required to slow the vehicle.

- 2 Shift the shift lever to N.
  - ▶ If the shift lever is shifted to N
- 3 After slowing down, stop the vehicle in a safe place by the road.
- 4 Stop the engine.
  - ▶ If the shift lever cannot be shifted to N
- 3 Keep depressing the brake pedal with both feet to reduce vehicle speed as much as possible.
- 4 Perform the following procedure to stop the engine:
  - ▶ Vehicles without smart key system

Turn the engine switch to ACC.

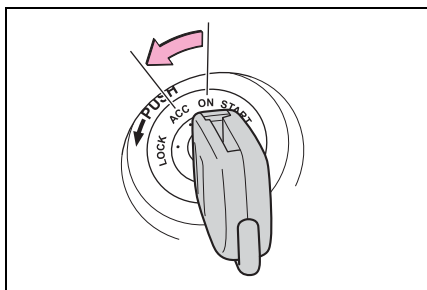

► Vehicles with smart key system

Press and hold the engine switch for 2 consecutive seconds or more, or press it briefly 3 times or more in succession.

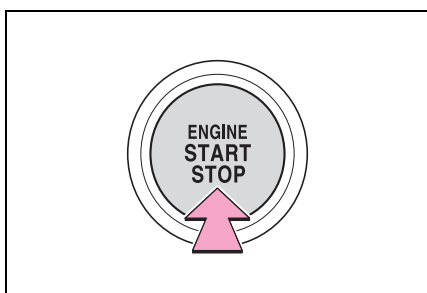

- 5 Stop the vehicle in a safe place by the road.

**⚠ WARNING**

■ **If the engine has to be turned off while driving**

- Power assist for the brakes and steering wheel will be lost, making the brake pedal harder to depress and the steering wheel heavier to turn. Decelerate as much as possible before turning off the engine.
- Vehicles without smart key system: Never attempt to remove the key, as doing so will lock the steering wheel.

**If the vehicle is trapped in rising water**

**In the event the vehicle is submerged in water, remain calm and perform the following.**

- Remove the seat belt first.
- If the door can be opened, open the door and exit the vehicle.
- If the door can not be opened, open the window using the power window switch and exit the vehicle through the window.
- If the window can not be opened using the power window switch, remain calm, wait until the water level inside the vehicle rises to the point that the water pressure inside of the vehicle equals the water pressure outside of the vehicle, and then open the door and exit the vehicle.



**WARNING**

■ **Using an emergency hammer\* for emergency escape**

The front side windows and rear side windows, as well as the rear window can be shattered with an emergency hammer\* used for emergency escape. However, an emergency hammer can not shatter the windshield as it is laminated glass.

\*: Contact your Toyota dealer, or aftermarket accessory manufacturer for further information about an emergency hammer.

■ **Escaping the vehicle from the window**

There are cases where escaping the vehicle from the window is not possible due to seating position, passenger body type, etc.

When using an emergency hammer, consider your seat location and the size of the window opening to ensure that the opening is accessible and large enough to escape.

**If your vehicle needs to be towed**

**If towing is necessary, we recommend having your vehicle towed by your Toyota dealer or commercial towing service, using a wheel-lift type truck or flatbed truck.**

**Use a safety chain system for all towing, and abide by all state/provincial and local laws.**

**2WD models: If towing your vehicle with a wheel-lift type truck from the front, the vehicle's rear wheels and axles must be in good conditions. (→P.623)**

**If they are damaged, use a towing dolly or flatbed truck.**

**AWD models: If towing your vehicle with a wheel-lift type truck, use a towing dolly. (→P.623)**

**⚠ WARNING**

Observe the following precautions.

Failure to do so may result in death or serious injury.

**■ When towing the vehicle**

▶ 2WD models

Be sure to transport the vehicle with the front wheels raised or with all four wheels raised off the ground. If the vehicle is towed with the front wheels contacting the ground, the drivetrain and related parts may be damaged.

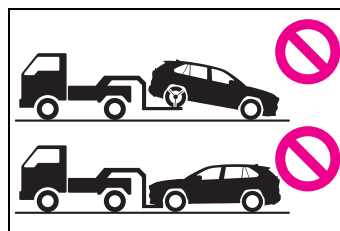

▶ AWD models

Be sure to transport the vehicle with all four wheels raised off the ground. If the vehicle is towed with the tires contacting the ground, the drivetrain or related parts may be damaged, the vehicle may fly off the truck.

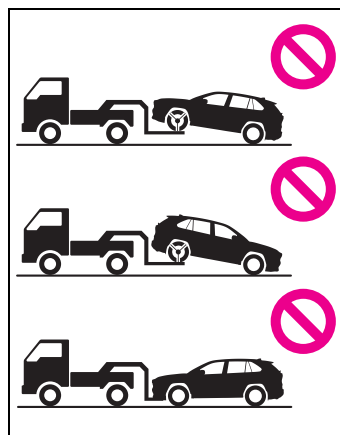

**⚠ WARNING**

■ **While towing (vehicles with towing eyelet)**

- When towing using cables or chains, avoid sudden starts, etc. which place excessive stress on the towing eyelets, cables or chains. The towing eyelets, cables or chains may become damaged, broken debris may hit people, and cause serious damage.
- Do not turn the engine switch to OFF.  
There is a possibility that the steering wheel is locked and cannot be operated.

■ **Installing towing eyelet to the vehicle (vehicles with towing eyelet)**

Make sure that towing eyelet is installed securely.

If not securely installed, towing eyelet may come loose during towing.

**⚠ NOTICE**

■ **To prevent damage to the vehicle when towing using a wheel-lift type truck**

- Do not tow the vehicle from the rear when the engine switch is in OFF or the key is removed (vehicles without smart key system). The steering lock mechanism is not strong enough to hold the front wheels straight.
- When raising the vehicle, ensure adequate ground clearance for towing at the opposite end of the raised vehicle. Without adequate clearance, the vehicle could be damaged while being towed.

■ **To prevent damage to the vehicle when towing with a sling-type truck**

Do not tow with a sling-type truck, either from the front or rear.

■ **To prevent damage to the vehicle during emergency towing (vehicles with towing eyelet)**

Do not secure cables or chains to the suspension components.

■ **When towing the vehicle (vehicles with Stop & Start system)**

If it is necessary to tow the vehicle with all four wheels on the ground, perform the following procedure before towing the vehicle, in order to protect the system.  
Turn the engine switch to OFF and then start the engine or turn the engine switch to ON.

■ **Recreational towing (behind motor home, etc.)**

Never dinghy tow your vehicle to prevent causing serious damage to the AWD system (AWD models) and transmission. (→P.191)

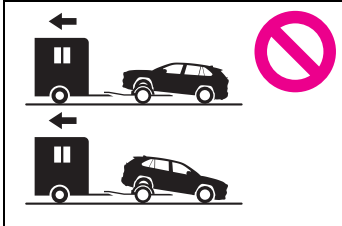

**Situations when it is necessary to contact dealers before towing**

The following may indicate a problem with your transmission. Contact your Toyota dealer or commercial towing service

before towing.

- The engine is running but the vehicle does not move.
- The vehicle makes an abnormal sound.

**Towing with a wheel-lift type truck**

- ▶ From the front (2WD models)  
Release the parking brake.  
Turn automatic mode off.  
(→P.204)

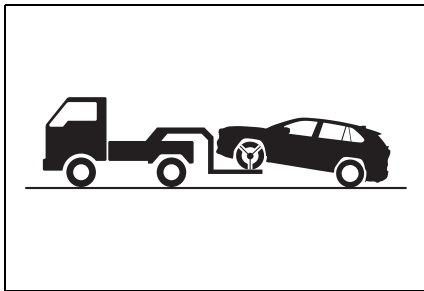

- ▶ From the front (AWD models)  
Use a towing dolly under the rear wheels.

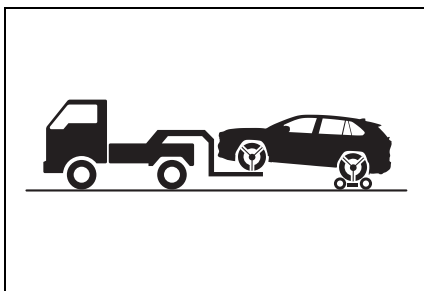

- ▶ From the rear  
Use a towing dolly under the front wheels.

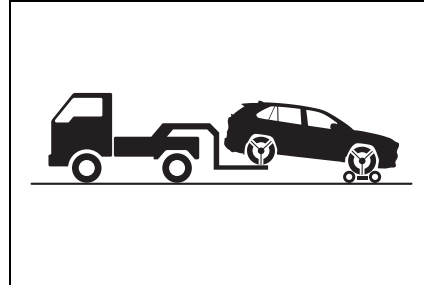

 NOTICE

**■ Towing with a sling-type truck**

Do not tow with a sling-type truck to prevent body damage.

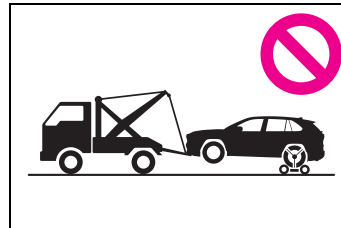

**Using a flatbed truck**

When using a flat-bed truck to transport the vehicle, use tire strapping belts. Refer to the owner's manual of the flat-bed truck for the tire strapping method.

In order to suppress vehicle movement during transportation, set the parking brake and turn the engine switch off.

**Emergency towing (vehicles with towing eyelet)**

If a tow truck is not available in an emergency, your vehicle may be temporarily towed using

cables or chains secured to the emergency towing eyelets. This should only be attempted on hard surfaced roads for at most 50 miles (80 km) at under 18 mph (30 km/h).

A driver must be in the vehicle to steer and operate the brakes. The vehicle's wheels, drive train, axles, steering and brakes must be in good condition.

**Emergency towing procedure (vehicles with towing eyelet)**

To have your vehicle towed by another vehicle, the towing eyelet must be installed to your vehicle. Install the towing eyelet by following the specified procedure.

- 1 Take out the towing eyelet. (→P.643)
- 2 Using a flathead screwdriver, remove eyelet cover (A), and then remove eyelet cover (B).

To protect the bodywork, place a rag between the screwdriver and the vehicle body as shown in the illustration.

► Type A

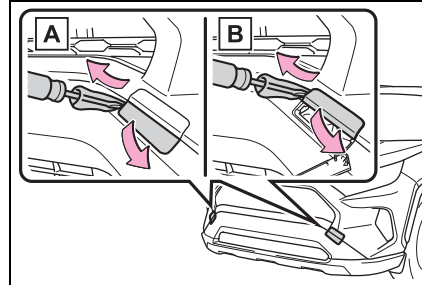

► Type B

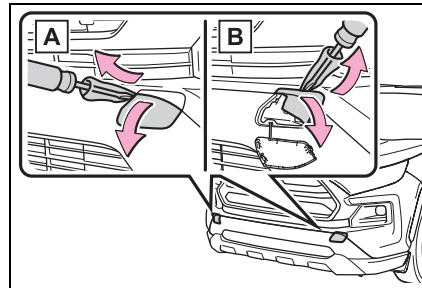

- 3 Insert the towing eyelet into the hole and tighten partially by hand.

► Type A

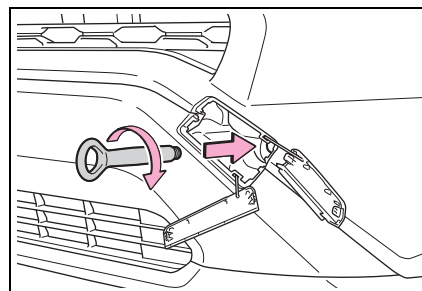



► Type B

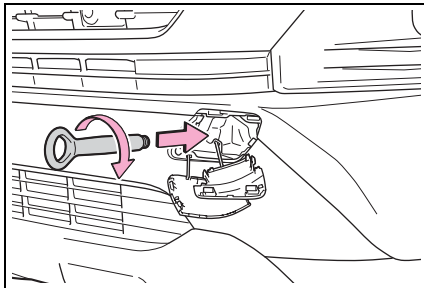

4 Tighten down the towing eyelet securely using a wheel nut wrench or hard metal bar.

► Type A

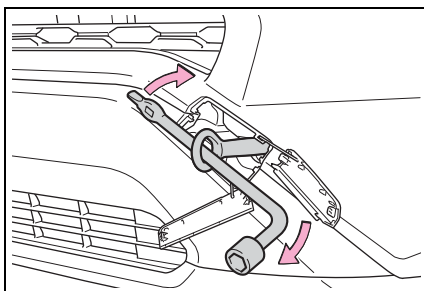

► Type B

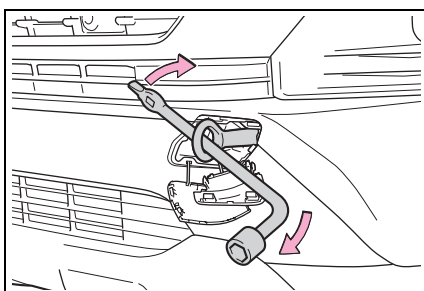

5 Securely attach cables or chains to the towing eyelet.

Take care not to damage the vehicle body.

6 Enter the vehicle being towed and start the engine.

Turn off the Parking Support Brake

function. (if equipped): →P.282

If the engine does not start, turn the engine switch to ON.

Vehicles with Stop & Start system: Before towing the vehicle, turn the engine switch to OFF once, and then start the engine.

7 Shift the shift lever to N and release the parking brake.

When the shift lever cannot be shifted: →P.200

■ While towing

If the engine is not running, the power assist for the brakes and steering will not function, making steering and braking more difficult.

■ Wheel nut wrench

Wheel nut wrench is installed in the tool bag. (→P.643)

**If you think something is wrong**

**If you notice any of the following symptoms, your vehicle probably needs adjustment or repair. Contact your Toyota dealer as soon as possible.**

**Visible symptoms**

- Fluid leaks under the vehicle (Water dripping from the air conditioning after use is normal.)
- Flat-looking tires or uneven tire wear
- Engine coolant temperature gauge needle continually points higher than normal.

**Audible symptoms**

- Changes in exhaust sound
- Excessive tire squeal when cornering
- Strange noises related to the suspension system
- Pinging or other noises related to the engine

**Operational symptoms**

- Engine missing, stumbling or running roughly
- Appreciable loss of power
- Vehicle pulls heavily to one

side when braking

- Vehicle pulls heavily to one side when driving on a level road
- Loss of brake effectiveness, spongy feeling, pedal almost touches the floor

### Fuel pump shut off system

To minimize the risk of fuel leakage when the engine stalls or when an airbag inflates upon collision, the fuel pump shut off system stops the supply of fuel to the engine.

### Restarting the engine

Follow the procedure below to restart the engine after the system is activated.

- 1 Turn the engine switch to ACC or off.
- 2 Restart the engine.



 NOTICE
<p>■ <b>Before starting the engine</b> Inspect the ground under the vehicle. If you find that fuel has leaked onto the ground, the fuel system has been damaged and is in need of repair. Do not restart the engine.</p>

## If a warning light turns on or a warning buzzer sounds

Calmly perform the following actions if any of the warning lights comes on or flashes. If a light comes on or flashes, but then goes off, this does not necessarily indicate a malfunction in the system. However, if this continues to occur, have the vehicle inspected by your Toyota dealer.

### Actions to the warning lights or warning buzzers

#### ■ Brake system warning light (warning buzzer)

Warning light	Details/Actions
 (U.S.A.)  (Canada) (Red)	Indicates that: <ul style="list-style-type: none"> <li>● The brake fluid level is low; or</li> <li>● The brake system is malfunctioning</li> </ul> → <b>Immediately stop the vehicle in a safe place and contact your Toyota dealer. Continuing to drive the vehicle may be dangerous.</b>

#### ■ Brake system warning light

Warning light	Details/Actions
 (Yellow)	Indicates a malfunction in the parking brake system → <b>Have the vehicle inspected by your Toyota dealer immediately.</b>

#### ■ Charging system warning light

Warning light	Details/Actions
	Indicates a malfunction in the vehicle's charging system → <b>Immediately stop the vehicle in a safe place and contact your Toyota dealer.</b>

■ **High coolant temperature warning light\* (warning buzzer)**

Warning light	Details/Actions
	Indicates that the engine is overheating → <b>Immediately stop the vehicle in a safe place.</b> <b>Handling method (→P.659)</b>



\* : This light illuminates on the multi-information display with a message.

■ **Low engine oil pressure warning light\* (warning buzzer)**

Warning light	Details/Actions
	Indicates that the engine oil pressure is too low → <b>Immediately stop the vehicle in a safe place and contact your Toyota dealer.</b>

\* : This light illuminates on the multi-information display with a message.



■ **Malfunction indicator lamp**

Warning light	Details/Actions
 (U.S.A.)	Indicates a malfunction in: <ul style="list-style-type: none"> <li>● The electronic engine control system;</li> <li>● The electronic throttle control system; or</li> <li>● The emission control system (if equipped)</li> </ul> → <b>Have the vehicle inspected by your Toyota dealer immediately.</b>
 (Canada)	

■ **SRS warning light**

Warning light	Details/Actions
	Indicates a malfunction in: <ul style="list-style-type: none"> <li>● The SRS airbag system;</li> <li>● The front passenger occupant classification system; or</li> <li>● The seat belt pretensioner system</li> </ul> → <b>Have the vehicle inspected by your Toyota dealer immediately.</b>

### ■ ABS warning light

Warning light	Details/Actions
 (U.S.A.)  (Canada)	Indicates a malfunction in: <ul style="list-style-type: none"> <li>● The ABS; or</li> <li>● The brake assist system</li> </ul> → <b>Have the vehicle inspected by your Toyota dealer immediately.</b>

### ■ Electric power steering system warning light (warning buzzer)

Warning light	Details/Actions
 (Red/yellow)	Indicates a malfunction in the EPS (Electric Power Steering) system → <b>Have the vehicle inspected by your Toyota dealer immediately.</b>

### ■ PCS warning light (warning buzzer)

Warning light	Details/Actions
 (Flashes or illuminates)	When a buzzer sounds simultaneously: Indicates a malfunction has occurred in the PCS (Pre-Collision System). → <b>Have the vehicle inspected by your Toyota dealer immediately.</b>  When a buzzer does not sound: The PCS (Pre-Collision System) has become temporarily unavailable, corrective action may be necessary. → <b>Follow the instructions displayed on the multi-information display. (→P.227, 641)</b>  If the PCS (Pre-Collision System) or VSC (Vehicle Stability Control) system is disabled, the PCS warning light will illuminate. → <b>P.236</b>

■ LTA indicator (warning buzzer)

Warning light	Details/Actions
 <p>(Orange)</p>	<p>Indicates a malfunction in the LTA (Lane Tracing Assist)</p> <p>→ <b>Follow the instructions displayed on the multi-information display. (→P.246)</b></p>

■ Stop & Start cancel indicator

Warning light	Details/Actions
 <p>(Flashes) (If equipped)</p>	<p>Indicates a malfunction in the Stop &amp; Start system</p> <p>→ <b>Have the vehicle inspected by your Toyota dealer immediately.</b></p>

■ Intuitive parking assist OFF indicator (warning buzzer)

Warning light	Details/Actions
 <p>(Flashes) (If equipped)</p>	<p>When a buzzer sounds: Indicates a malfunction in the Intuitive parking assist function</p> <p>→ <b>Have the vehicle inspected by your Toyota dealer immediately.</b></p> <p>When a buzzer does not sound: Indicates that the system is temporarily unavailable, possibly due to a sensor being dirty or covered with ice, etc.</p> <p>→ <b>Follow the instructions displayed on the multi-information display. (→P.273, 639)</b></p>

### ■ PKSB OFF indicator (warning buzzer)

Warning light	Details/Actions
 (Flashes) (If equipped)	<p>When a buzzer sounds:            Indicates a malfunction in the PKSB (Parking Support Brake) system            → <b>Have the vehicle inspected by your Toyota dealer immediately.</b></p> <p>When a buzzer does not sound:            Indicates that the system is temporarily unavailable, possibly due to a sensor being dirty or covered with ice, etc.            → <b>Follow the instructions displayed on the multi-information display. (→P.281, 639)</b></p>

### ■ RCTA OFF indicator (warning buzzer)

Warning light	Details/Actions
 (Flashes) (If equipped)	<p>When a buzzer sounds:            Indicates a malfunction in the RCTA (Rear Cross Traffic Alert) function            → <b>Have the vehicle inspected by your Toyota dealer immediately.</b></p> <p>When a buzzer does not sound:            Indicates that the rear bumper around the radar sensor is covered with dirt, etc. (→P.263)            → <b>Follow the instructions displayed on the multi-information display. (→P.262, 639)</b></p>

### ■ Slip indicator light

Warning light	Details/Actions
	<p>Indicates a malfunction in:</p> <ul style="list-style-type: none"> <li>● Multi-terrain Select brake control (if equipped);</li> <li>● The VSC/Trailer Sway Control system;</li> <li>● The TRAC system;</li> <li>● The hill-start assist control system; or</li> <li>● The downhill assist control system (if equipped)</li> </ul> <p>→ <b>Have the vehicle inspected by your Toyota dealer immediately.</b></p>



■ **Brake Override System/Drive-Start Control/PKSB (if equipped) warning light\* (warning buzzer)**



Warning light	Details/Actions
	<p><b>Brake Override System</b>                      Indicates that the accelerator and brake pedals are being depressed simultaneously, and the Brake Override System is operating.                      → <b>Release the accelerator pedal and depress the brake pedal.</b></p> <p>Indicates a malfunction in the Brake Override System (with warning buzzer)                      → <b>Have the vehicle inspected by your Toyota dealer immediately.</b></p> <hr/> <p><b>Drive-Start Control</b>                      Indicates that the shift position was changed and Drive-Start Control was operated while depressing the accelerator pedal. (with warning buzzer)                      → <b>Momentarily release the accelerator pedal.</b></p> <p>Indicates a malfunction in the Drive-Start Control (with warning buzzer)                      → <b>Have the vehicle inspected by your Toyota dealer immediately.</b></p> <hr/> <p><b>PKSB (if equipped)</b>                      Parking Support Brake function (for static objects) is operating. (→P.277)                      → <b>If a warning message is shown on the multi-information display, read the message and follow the instructions.</b></p>

\*: This light illuminates on the multi-information display with a message.

■ **Brake hold operated indicator (warning buzzer)**

Warning light	Details/Actions
 <p>(Flashes)</p>	<p>Indicates a malfunction in the brake hold system                      → <b>Have the vehicle inspected by your Toyota dealer immediately.</b></p>

### ■ Parking brake indicator

Warning light	Details/Actions
 (U.S.A.) (Flashes)	<p>It is possible that the parking brake is not fully engaged or released            → <b>Operate the parking brake switch once again.</b></p>
 (Canada) (Flashes)	<p>This light comes on when the parking brake is not released. If the light turns off after the parking brake is fully released, the system is operating normally.</p>

### ■ Tire pressure warning light

Warning light	Details/Actions
 (If equipped)	<p>When the light comes on after blinking for 1 minute:            Malfunction in the tire pressure warning system            → <b>Have the system checked by your Toyota dealer.</b></p> <p>When the light comes on:            Low tire inflation pressure such as</p> <ul style="list-style-type: none"> <li>● Natural causes</li> <li>● Flat tire</li> </ul> <p>→ <b>Immediately stop the vehicle in a safe place.</b>  <b>Handling method (→P.636)</b></p>

### ■ Low fuel level warning light

Warning light	Details/Actions
	<p>Indicates that remaining fuel is approximately 2.2 gal. (8.3 L, 1.8 Imp. gal.) or less            → <b>Refuel the vehicle.</b></p>

■ **Driver’s and front passenger’s seat belt reminder light (warning buzzer\*)**

Warning light	Details/Actions
	Warns the driver and/or front passenger to fasten their seat belts → <b>Fasten the seat belt.</b> <b>If the front passenger’s seat is occupied, the front passenger’s seat belt also needs to be fastened to make the warning light (warning buzzer) turn off.</b>

\*: Driver’s seat belt warning buzzer:

The driver’s seat belt warning buzzer sounds to alert the driver that his or her seat belt is not fastened. Once the engine switch is turned to ON, the buzzer sounds. If the seat belt is still unfastened, the buzzer sounds intermittently for a certain period of time after the vehicle reaches a certain speed.

Front passenger’s seat belt warning buzzer:

The front passenger’s seat belt warning buzzer sounds to alert the front passenger that his or her seat belt is not fastened. If the seat belt is unfastened, the buzzer sounds intermittently for a certain period of time after the vehicle reaches a certain speed.

■ **Rear passengers’ seat belt reminder light (warning buzzer\*)**

Warning light	Details/Actions
 (If equipped)	Warns the rear passengers to fasten their seat belts → <b>Fasten the seat belt.</b>

\*: Rear passengers’ seat belt warning buzzer:

The rear passengers’ seat belt warning buzzer sounds to alert the rear passenger that his or her seat belt is not fastened. If the seat belt is unfastened, the buzzer sounds intermittently for a certain period of time, after the seat belt is fastened and unfastened and the vehicle reaches a certain speed.

■ **Warning buzzer**

In some cases, the buzzer may not be heard because of noisy place or an audio sound.

■ **Front passenger detection sensor, seat belt reminder and warning buzzer**

- If luggage is placed on the front passenger seat, the front passenger detection sensor may cause the warning light to flash and the warning buzzer to sound even if a passenger is not sitting in the

seat.

- If a cushion is placed on the seat, the sensor may not detect a passenger, and the warning light may not operate properly.

#### ■ SRS warning light

This warning light system monitors the airbag sensor assembly, front impact sensors, side impact sensors (front door), side impact sensors (front), side impact sensors (rear), driver's seat position sensor, driver's seat belt buckle switch, front passenger occupant classification system (ECU and sensors), "AIR BAG ON" indicator light, "AIR BAG OFF" indicator light, front passenger's seat belt buckle switch, seat belt pretensioners and force limiters, airbags, interconnecting wiring and power sources. (→P.34)

#### ■ If the malfunction indicator lamp comes on while driving

First check the following:

- Is the fuel tank empty?

If it is, fill the fuel tank immediately.

- Is the fuel tank cap loose?

If it is, tighten it securely.

The light will go off after several driving trips.

If the light does not go off even after several trips, contact your Toyota dealer as soon as possible.

#### ■ Electric power steering system warning light (warning buzzer)

When the battery charge becomes insufficient or the voltage temporarily drops, the electric power steering system warning light may come on and the warning buzzer may sound.

#### ■ When the tire pressure warning light comes on (vehicles with tire pressure warning system)

Inspect the tires to check if a tire is punctured.

If a tire is punctured: →P.642

If none of the tires are punctured:

Turn the engine switch to OFF then turn it to ON. Check if the tire pressure warning light comes on or blinks.

- ▶ If the tire pressure warning light blinks for approximately 1 minute then stays on

There may be a malfunction in the tire pressure warning system. Have the vehicle inspected by your Toyota dealer immediately.

- ▶ If the tire pressure warning light comes on

- 1 After the temperature of the tires has lowered sufficiently, check the inflation pressure of each tire and adjust them to the specified level.
- 2 If the warning light does not turn off even after several minutes have elapsed, check that the inflation pressure of each tire is at the specified level and perform initialization. (→P.590)

#### ■ The tire pressure warning light may come on due to natural causes (vehicles with tire pressure warning system)

The tire pressure warning light may come on due to natural causes such as natural air leaks and tire inflation pressure changes caused by temperature. In this case, adjusting the tire inflation pressure will turn off the warning light (after a few minutes).

#### ■ When a tire is replaced with a compact spare tire (vehicles with tire pressure warning system)

The compact spare tire is not equipped with a tire pressure warning valve and transmitter. If a tire goes flat, the tire pressure warning light will not turn off even though the flat tire has been replaced with the spare tire. Replace the spare tire with the standard tire and adjust the tire inflation pressure. The tire pres-

sure warning light will go off after a few minutes.

■ **Conditions that the tire pressure warning system may not function properly**

→P.584



**WARNING**

■ **If a warning light comes on or a warning buzzer sounds when a warning message is shown on the multi-information display\***

Check and follow the message shown on the multi-information display.

Failure to do so may result in death or serious injury.

\*: Warning lights illuminate in red or yellow and the warning buzzer beeps once or sounds continuously.

■ **When the electric power steering system warning light comes on**

When the light comes on yellow, the assist to the power steering is restricted. When the light comes on red, the assist to the power steering is lost and handling operations of the steering wheel become extremely heavy. If the steering wheel becomes heavier than usual when operating, hold firmly and operate using more force than usual.

■ **If the tire pressure warning light comes on (vehicles with tire pressure warning system)**

Be sure to observe the following precautions. Failure to do so could cause a loss of vehicle control and result in death or serious injury.

- Stop your vehicle in a safe place as soon as possible. Adjust the tire inflation pressure immediately.
- If the tire pressure warning light comes on even after tire inflation pressure adjustment, it is probable that you have a flat tire. Check the tires. If a tire is flat, change it with the spare tire and have the flat tire repaired by the nearest Toyota dealer.
- Avoid abrupt maneuvering and braking. If the vehicle tires deteriorate, you could lose control of the steering wheel or the brakes.

■ **If a blowout or sudden air leakage should occur (vehicles with tire pressure warning system)**

The tire pressure warning system may not activate immediately.

 **WARNING****■ Maintenance of the tires (vehicles with tire pressure warning system)**

Each tire, including the spare (if provided), should be checked monthly when cold and inflated to the inflation pressure recommended by the vehicle manufacturer on the vehicle placard or tire inflation pressure label (tire and load information label). (If your vehicle has tires of a different size than the size indicated on the vehicle placard or tire inflation pressure label [tire and load information label], you should determine the proper tire inflation pressure for those tires.)

As an added safety feature, your vehicle has been equipped with a tire pressure monitoring system (TPMS-tire pressure warning system) that illuminates a low tire pressure telltale (tire pressure warning light) when one or more of your tires is significantly under-inflated. Accordingly, when the low tire pressure telltale (tire pressure warning light) illuminates, you should stop and check your tires as soon as possible, and inflate them to the proper pressure. Driving on a significantly under-inflated tire causes the tire to overheat and can lead to tire failure. Under-inflation also reduces fuel efficiency and tire tread life, and may affect the vehicle's handling and stopping ability.

Please note that the TPMS (tire pressure warning system) is not a substitute for proper tire maintenance, and it is the driver's responsibility to maintain correct tire pressure, even if under-inflation has not reached the level to trigger illumination of the TPMS low tire pressure telltale (tire pressure warning light).

Your vehicle has also been equipped with a TPMS (tire pressure warning system) malfunction indicator to indicate when the system is not operating properly. The TPMS (tire pressure warning system) malfunction indicator is combined with the low tire pressure telltale (tire pressure warning light). When the system detects a malfunction, the telltale will flash for approximately one minute and then remain continuously illuminated. This sequence will continue upon subsequent vehicle start-ups as long as the malfunction exists. When the malfunction indicator is illuminated, the system may not be able to detect or signal low tire pressure as intended.

TPMS (tire pressure warning system) malfunctions may occur for a variety of reasons, including the installation of replacement or alternate tires or wheels on the vehicle that prevent the TPMS (tire pressure warning system) from functioning properly. Always check the TPMS (tire pressure warning system) malfunction telltale after replacing one or more tires or wheels on your vehicle to ensure that the replacement or alternate tires and wheels allow the TPMS (tire pressure warning system) to continue to function properly.

 **NOTICE****■ To ensure the tire pressure warning system operates properly (vehicles with tire pressure warning system)**

Do not install tires with different specifications or manufacturers as the tire pressure warning system may not operate properly.

### If a warning message is displayed

**The multi-information display shows warnings of system malfunctions, incorrectly performed operations, and messages that indicate a need for maintenance. When a message is shown, perform the correction procedure appropriate to the message.**

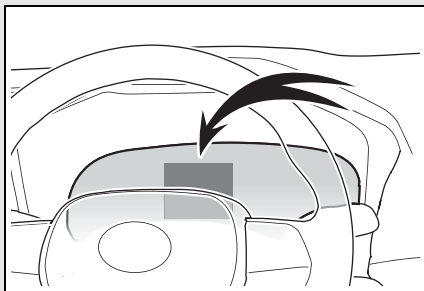

If a warning message is displayed again after the appropriate actions have been performed, contact your Toyota dealer.

#### ■ Warning messages

The warning messages explained below may differ from the actual messages according to operation conditions and vehicle specifications.

##### ■ If a message about an operation is shown

- If a message about an operation of the accelerator pedal or brake pedal is shown

A warning message about an operation of the brake pedal may be

shown while the driving assist systems such as PCS (Pre-Collision system) or the dynamic radar cruise control with full-speed range is operating. If a warning message is shown, be sure to decelerate the vehicle or follow an instruction shown on the multi-information display.

A warning message is shown when Brake Override System, Drive-Start Control or Parking Support Brake (if equipped) (→P.170, 277) operates. Follow the instructions on the multi-information display.

- If a message about an operation of the engine switch is shown

An instruction for operation of the engine switch is shown when the incorrect procedure for starting the engine is performed or the engine switch is operated incorrectly. Follow the instructions shown on the multi-information display to operate the engine switch again.

- If a message about a shift lever operation is shown

To prevent the shift lever from being operated incorrectly or the vehicle from moving unexpectedly, a message that requires shifting the shift lever may be shown on the multi-information display. In that case, follow the instruction of the message and shift the shift lever.

- If a message or image about an open/close state of a part or replenishment of a consumable is shown

Confirm the part indicated by the multi-information display or a warning light, and then perform the coping method such as closing the open door or replenishing a con-

sumable.

■ **If a message that indicates the need for visiting your Toyota dealer is displayed**

The system or part shown on the multi-information display is malfunctioning. Have the vehicle inspected by your Toyota dealer immediately.

■ **If a message that indicates the need for referring to Owner's Manual is displayed**

● If "Engine Coolant Temp High" is shown, follow the instructions (→P.659).

● If the following messages are shown, there may be a malfunction. Immediately stop the vehicle in a safe place and contact your Toyota dealer. Continuing to drive the vehicle may be dangerous.

- "Charging System Malfunction"
- "High Transmission Fluid Temp"
- "Smart Key System Malfunction"

● If the following messages are shown, there may be a malfunction.

- Immediately have the vehicle inspected by your Toyota dealer.
- "Oil Pressure Low"
- "Braking Power Low"

■ **If "Shift to P when Parked" is shown**

Message is displayed when the driver's door is opened without turning the engine switch to OFF with the shift lever in any position other than P.

Shift the shift lever to P.

■ **If "Auto Power OFF to Conserve Battery" is shown**

Power was turned off due to the automatic power off function.

Next time when starting the engine, increase the engine speed slightly and maintain that level for approximately 5 minutes to recharge the battery.

■ **If "Engine Oil Level Low Add or Replace" is displayed**

The engine oil level may be low. Check the level of the engine oil, and add engine oil if necessary. This message may be displayed if the vehicle is stopped on a slope. Move the vehicle to a level surface and check if the message disappears.

■ **If "Maintenance Required Soon" is shown**

Indicates that all maintenance according to the driven distance on the maintenance schedule\* should be performed soon.

Comes on approximately 4500 miles (7200 km) after the message has been reset.

If necessary, perform maintenance. Please reset the message after the maintenance is performed. (→P.565)

\*: Refer to the separate "Scheduled Maintenance Guide" or "Owner's Manual Supplement" for the maintenance interval applicable to your vehicle.

■ **If "Maintenance Required Visit Your Dealer" is shown**

Indicates that all maintenance is required to correspond to the driven distance on the maintenance schedule\*.

Comes on approximately 5000 miles (8000 km) after the message has been reset. (The indicator will not work properly unless the message has been reset.)

Perform the necessary maintenance. Please reset the message after the maintenance is performed. (→P.565)

\*: Refer to the separate "Scheduled Maintenance Guide" or "Owner's Manual Supplement" for the maintenance interval applicable to your vehicle.



■ **If “Front Camera Unavailable” or “Front Camera Unavailable See Owner’s Manual” is displayed**

The following systems may be suspended until the problem shown in the message is resolved. (→P.445, 630)

- PCS (Pre-Collision System)
- LTA (Lane Tracing Assist)
- Automatic High Beam
- RSA (Road Sign Assist)\*
- Dynamic radar cruise control with full-speed range

\*: If equipped

■ **If “Radar Cruise Control Unavailable See Owner’s Manual” is shown**

The dynamic radar cruise control with full-speed range system is suspended temporarily or until the problem shown in the message is resolved. (causes and coping methods: →P.445)

■ **If “Radar Cruise Control Unavailable” is shown**

The dynamic radar cruise control with full-speed range system cannot be used temporarily. Use the system when it becomes available again.

■ **Warning buzzer**

→P.635

 **WARNING**

■ **If a warning light comes on or a warning buzzer sounds when a warning message is shown on the multi-information display**

→P.637

 **NOTICE**

■ **“High Power Consumption Partial Limit On AC/Heater Operation” is frequently shown**

There is a possible malfunction relating to the charging system or the battery may be deteriorating. Have the vehicle inspected by your Toyota dealer.

### If you have a flat tire

**Your vehicle is equipped with a spare tire. The flat tire can be replaced with the spare tire.**  
**For details about tires: →P.581**

#### **WARNING**

##### ■ **If you have a flat tire**

Do not continue driving with a flat tire.

Driving even a short distance with a flat tire can damage the tire and the wheel beyond repair, which could result in an accident.

### Before jacking up the vehicle

- Stop the vehicle in a safe place on a hard, flat surface.
- Set the parking brake.
- Shift the shift lever to P.
- Stop the engine.
- Turn on the emergency flashers. (→P.618)
- For vehicles with power back door: Turn off the power back door system. (→P.127)

**Location of the spare tire, jack and tools**

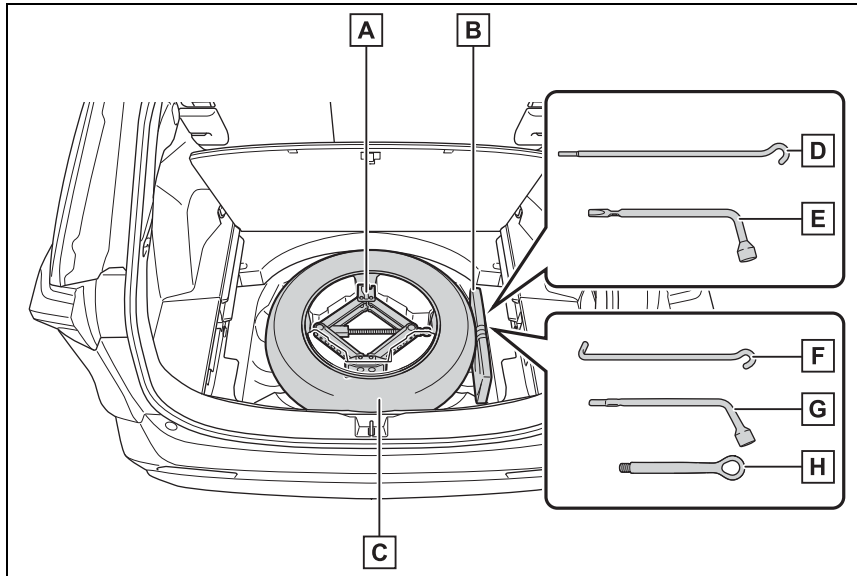

- A** Jack
- B** Tool bag
- C** Spare tire
- D** Jack handle<sup>\*1</sup>
- E** Wheel nut wrench<sup>\*1</sup>
- F** Jack handle<sup>\*2</sup>
- G** Wheel nut wrench<sup>\*2</sup>
- H** Towing eyelet<sup>\*2</sup> (if equipped)

<sup>\*1</sup>: Except for models made in Japan<sup>\*3</sup>

<sup>\*2</sup>: For models made in Japan<sup>\*3</sup>

<sup>\*3</sup>: The country of production is written on the Certification Regulation label.  
(→P.665)

**⚠ WARNING**

**■ Using the tire jack**

Observe the following precautions.

Improper use of the tire jack may cause the vehicle to suddenly fall off the jack, leading to death or serious injury.

- Do not use the tire jack for any purpose other than replacing tires or installing and removing tire chains.
- Only use the tire jack that comes with this vehicle for replacing a flat tire. Do not use it on other vehicles, and do not use other tire jacks for replacing tires on this vehicle.
- Put the jack properly in its jack point.

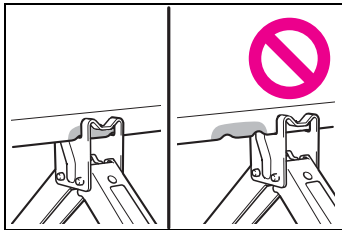

- Do not put any part of your body under the vehicle while it is supported by the jack.
- Do not start the engine or drive the vehicle while the vehicle is supported by the jack.
- Do not raise the vehicle while someone is inside.
- When raising the vehicle, do not put an object on or under the jack.
- Do not raise the vehicle to a height greater than that required to replace the tire.

- Use a jack stand if it is necessary to get under the vehicle.
- Stop the vehicle on firm, flat and level ground, firmly set the parking brake and shift the shift lever to P. Block the wheel diagonally opposite to the one being changed if necessary.
- When lowering the vehicle, make sure that there is no-one near the vehicle. If there are people nearby, warn them vocally before lowering.

**Taking out the jack**

- 1 Open the deck board (→P.532).
- 2 Take out the jack.

Do not touch the threaded portion of the jack as it is greased.

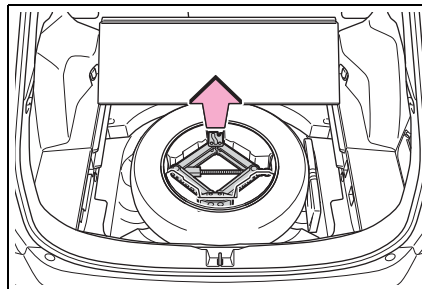

**Taking out the tool bag**

Take out the tool bag.

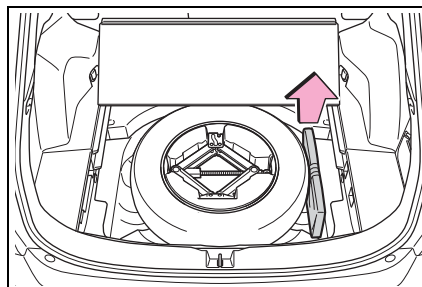

**Taking out the spare tire**

- 1 Take out the jack holder.

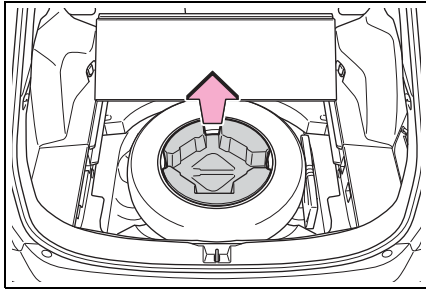

- 2 Loosen the center fastener that secures the spare tire.

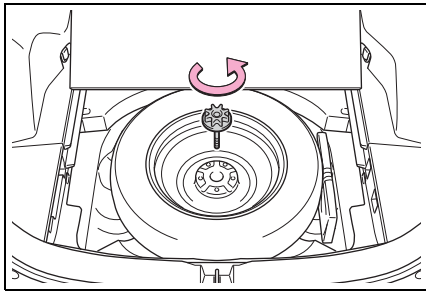

**⚠ WARNING**

**■ When storing the spare tire**

Be careful not to catch fingers or other body parts between the spare tire and the body of the vehicle.

**Replacing a flat tire**

- 1 Chock the tires.

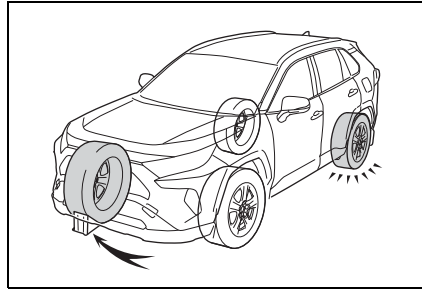

Flat tire	Wheel chock positions
Front left-hand side	Behind the rear right-hand side tire
Front right-hand side	Behind the rear left-hand side tire
Rear left-hand side	In front of the front right-hand side tire
Rear right-hand side	In front of the front left-hand side tire

- 2 For vehicles with full wheel ornament: Remove the wheel ornament using the wrench.

To prevent damage, cover the tip of the wrench with a rag.

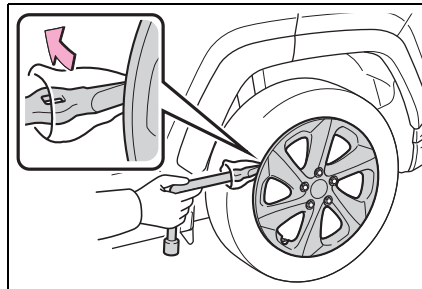

- 3 Slightly loosen the wheel nuts (one turn).

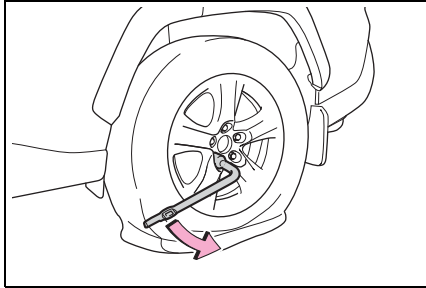

- 4 Turn the tire jack portion **A** by hand until the notch of the jack is in contact with the jack point.

After removing the jack from the jack holder, turn the jack portion **A** in the opposite direction to lower the jack, and then adjust the jack set position.

The jack point guides are located under the rocker panel. They indicate the jack point positions.

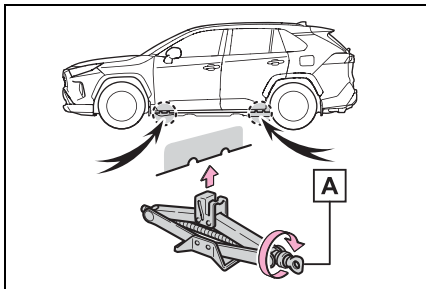

- 5 Assemble the jack handle and the wheel nut wrench as shown in the illustration.

- Except for models made in Japan\*

\*: The country of production is written on the Certification Regulation label. (→P.665)

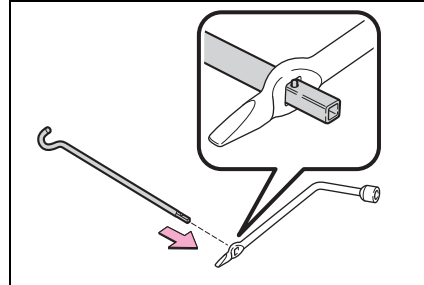

- For models made in Japan\*

\*: The country of production is written on the Certification Regulation label. (→P.665)

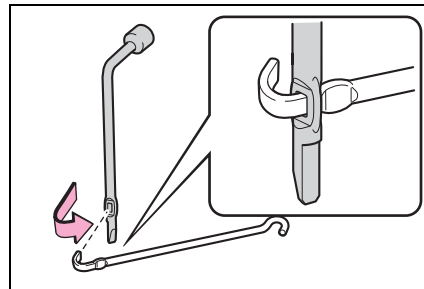

- 6 Raise the vehicle until the tire is slightly raised off the ground.

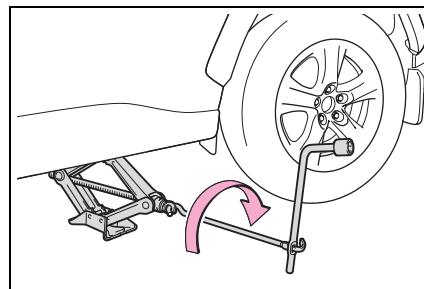

- 7 Remove all the wheel nuts and the tire.

When resting the tire on the ground, place the tire so that the wheel design faces up to avoid

scratching the wheel surface.

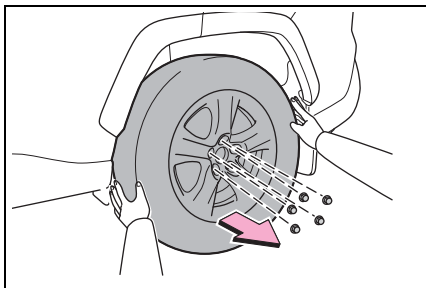

### WARNING

#### ■ Replacing a flat tire

- Do not touch the disc wheels or the area around the brakes immediately after the vehicle has been driven. After the vehicle has been driven the disc wheels and the area around the brakes will be extremely hot. Touching these areas with hands, feet or other body parts while changing a tire, etc. may result in burns.
- Failure to follow these precautions could cause the wheel nuts to loosen and the tire to fall off, resulting in death or serious injury.
- Have the wheel nuts tightened with a torque wrench to 76 ft•lbf (103 N•m, 10.5 kgf•m) as soon as possible after changing wheels.
- Do not attach a heavily damaged wheel ornament, as it may fly off the wheel while the vehicle is moving.
- When installing a tire, only use wheel nuts that have been specifically designed for that wheel.

- If there are any cracks or deformations in the bolt screws, nut threads or bolt holes of the wheel, have the vehicle inspected by your Toyota dealer.
- When installing the wheel nuts, be sure to install them with the tapered ends facing inward.
- For vehicles with power back door: In cases such as when replacing tires, make sure to turn off the power back door system (→P.127). Failure to do so may cause the back door to operate unintentionally if the power back door switch is accidentally touched, resulting in hands and fingers being caught and injured.

### Installing the spare tire

- 1 Remove any dirt or foreign matter from the wheel contact surface.

If foreign matter is on the wheel contact surface, the wheel nuts may loosen while the vehicle is in motion, causing the tire to come off.

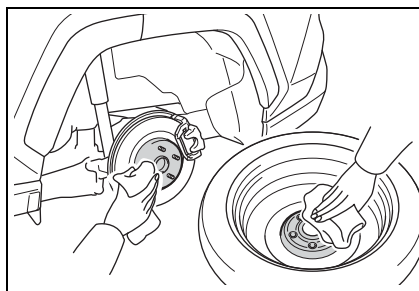

- 2 Install the spare tire and loosely tighten each wheel nut by hand by approximately the same amount.

When replacing a steel wheel with

648 **8-2. Steps to take in an emergency**

a steel wheel, tighten the nuts until the tapered portion **A** comes into loose contact with the disc wheel seat **B**.

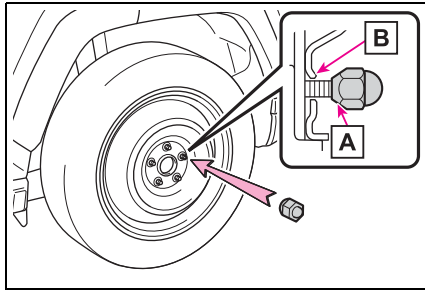

When replacing an aluminum wheel with a steel wheel, tighten the wheel nuts until the tapered portion **A** comes into loose contact with the disc wheel seat **B**.

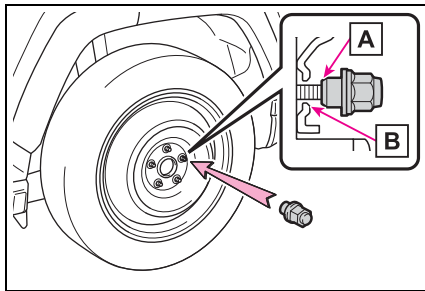

When replacing an aluminum wheel with an aluminum wheel, turn the wheel nuts until the washers **A** come into contact with the disc wheel **B**.

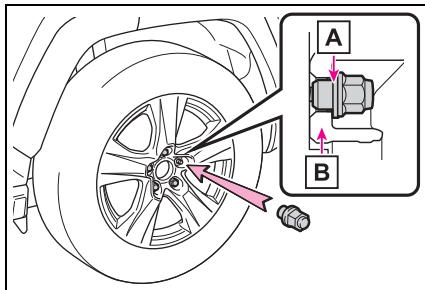

3 Lower the vehicle.

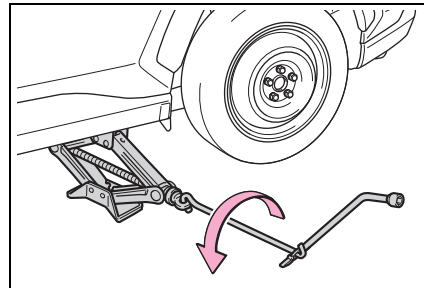

4 Firmly tighten each wheel nut two or three times in the order shown in the illustration.

Tightening torque:  
76 ft•lbf (103 N•m, 10.5 kgf•m)

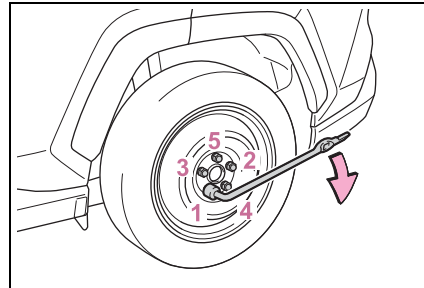

5 For vehicles with full wheel ornament: When reinstalling an original wheel, reinstall the wheel ornament\*.

Align the cutout of the wheel ornament with the valve stem as shown.

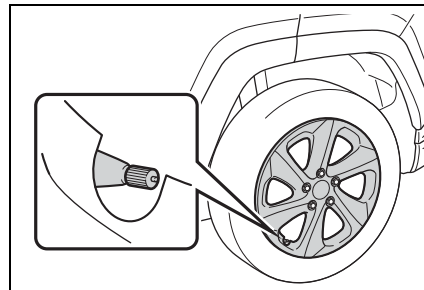

\*: The wheel ornament cannot be



installed on the compact spare tire.

- 6 Stow the flat tire, tire jack and all tools.

**■ The compact spare tire**

- The compact spare tire is identified by the label “TEMPORARY USE ONLY” on the tire sidewall. Use the compact spare tire temporarily, and only in an emergency.
- Make sure to check the tire inflation pressure of the compact spare tire. (→P.671)

**■ When using the compact spare tire**

As the compact spare tire is not equipped with a tire pressure warning valve and transmitter, low inflation pressure of the spare tire will not be indicated by the tire pressure warning system. Also, if you replace the compact spare tire after the tire pressure warning light comes on, the light remains on.

**■ When the compact spare tire is attached**

The vehicle height may become lower when driving with the compact spare tire compared to when driving with standard tires.

**■ If you have a flat front tire on a road covered with snow or ice**

Install the compact spare tire on one of the rear wheels of the vehicle. Perform the following steps and fit tire chains to the front tires:

- 1 Replace a rear tire with the compact spare tire.
- 2 Replace the flat front tire with the tire removed from the rear of the vehicle.
- 3 Fit tire chains to the front tires.

**■ When stowing the jack**

Before storing the jack, adjust the height of the jack to match the shape of the jack holder.

The storage direction of the jack differs depending on the type, so make sure to store the jack in the correct direction.

Except for models made in Japan\*:

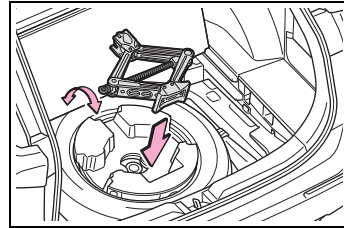

For models made in Japan\*:

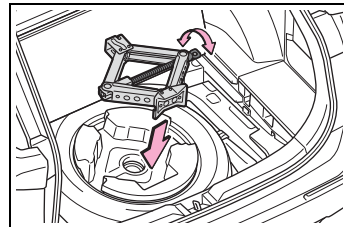

\*: The country of production is written on the Certification Regulation label. (→P.665)

**⚠ WARNING**

**■ When using the compact spare tire**

- Remember that the compact spare tire provided is specifically designed for use with your vehicle. Do not use your compact spare tire on another vehicle.
- Do not use more than one compact spare tire simultaneously.
- Replace the compact spare tire with a standard tire as soon as possible.
- Avoid sudden acceleration, abrupt steering, sudden braking and shifting operations that cause sudden engine braking.

**⚠ WARNING****■ When the compact spare tire is attached**

The vehicle speed may not be correctly detected, and the following systems may not operate correctly:

- ABS & Brake assist
- VSC/Trailer Sway Control
- TRAC
- Dynamic radar cruise control with full-speed range
- Dynamic radar cruise control
- PCS (Pre-Collision System)
- EPS
- LTA (Lane Tracing Assist)
- Tire pressure warning system (if equipped)
- AHB (Automatic High Beam)
- BSM (Blind Spot Monitor) (if equipped)
- Downhill assist control system (if equipped)
- Rear view monitor system (if equipped)
- Panoramic view monitor (if equipped)
- Toyota parking assist monitor (if equipped)
- Intuitive parking assist (if equipped)
- Navigation system (if equipped)

Also, not only can the following systems not be utilized fully, but they may actually negatively affect the drive-train components:

- Dynamic Torque Control AWD system (if equipped)

- Dynamic Torque Vectoring AWD system (if equipped)

**■ Speed limit when using the compact spare tire**

Do not drive at speeds in excess of 50 mph (80 km/h) when a compact spare tire is installed on the vehicle.

The compact spare tire is not designed for driving at high speeds. Failure to observe this precaution may lead to an accident causing death or serious injury.

**■ After using the tools and jack**

Before driving, make sure all the tools and jack are securely in place in their storage location to reduce the possibility of personal injury during a collision or sudden braking.

**⚠ NOTICE****■ Be careful when driving over bumps with the compact spare tire installed on the vehicle**

The vehicle height may become lower when driving with the compact spare tire compared to when driving with standard tires. Be careful when driving over uneven road surfaces.

**■ Driving with tire chains and the compact spare tire**

Do not fit tire chains to the compact spare tire.

Tire chains may damage the vehicle body and adversely affect driving performance.



## NOTICE

**■ When replacing the tires (vehicles with tire pressure warning system)**

When removing or fitting the wheels, tires or the tire pressure warning valve and transmitter, contact your Toyota dealer as the tire pressure warning valve and transmitter may be damaged if not handled correctly.

**If the engine will not start**

**If the engine will not start even though correct starting procedures are being followed (→P.193, 194), consider each of the following points:**

**The engine will not start even though the starter motor operates normally**

One of the following may be the cause of the problem:

- There may not be sufficient fuel in the vehicle's tank. Refuel the vehicle.
- The engine may be flooded. Try to restart the engine again following correct starting procedures. (→P.193, 194)
- There may be a malfunction in the engine immobilizer system. (→P.70)

**The starter motor turns over slowly, the interior lights and headlights are dim, or the horn does not sound or sounds at a low volume**

One of the following may be the cause of the problem:

- The battery may be discharged. (→P.655)

- The battery terminal connections may be loose or corroded.

### **The starter motor does not turn over (vehicles with smart key system)**

The engine starting system may be malfunctioning due to an electrical problem such as electronic key battery depletion or a blown fuse. However, an interim measure is available to start the engine. (→P.652)

### **The starter motor does not turn over, the interior lights and headlights do not turn on, or the horn does not sound**

One of the following may be the cause of the problem:

- The battery may be discharged. (→P.655)
- One or both of the battery terminals may be disconnected.
- There may be a malfunction in the steering lock system (vehicles with smart key system).

Contact your Toyota dealer if the problem cannot be repaired, or if repair procedures are unknown.

### **Emergency start function (vehicles with smart key system)**

When the engine does not start, the following steps can be used as an interim measure to start the engine if the engine switch is functioning normally:

- 1 Pull the parking brake switch to check that the parking brake is set. (→P.203)

Parking brake indicator will come on.

- 2 Shift the shift lever to P.
- 3 Turn the engine switch to ACC.
- 4 Press and hold the engine switch for about 15 seconds while depressing the brake pedal firmly.

Even if the engine can be started using the above steps, the system may be malfunctioning. Have the vehicle inspected by your Toyota dealer.

If you lose your keys

**New genuine keys can be made by your Toyota dealer using the other key and the key number stamped on your key number plate. Keep the plate in a safe place such as your wallet, not in the vehicle.**



NOTICE

■ **When an electronic key is lost (if equipped)**

If the electronic key remains lost, the risk of vehicle theft increases significantly. Visit your Toyota dealer immediately with all remaining electronic keys that were provided with your vehicle.

If the electronic key does not operate properly (vehicles with smart key system)

**If communication between the electronic key and vehicle is interrupted (→P.129) or the electronic key cannot be used because the battery is depleted, the smart key system and wireless remote control cannot be used. In such cases, the doors can be opened and the engine can be started by following the procedure below.**

■ **When the electronic key does not work properly**

- Make sure that the smart key system has not been deactivated in the customization setting. If it is off, turn the function on. (Customizable features: →P.691)
- Check if battery-saving mode is set. If it is set, cancel the function. (→P.129)



NOTICE

■ **In case of a smart key system malfunction, or other key related problems**

Take your vehicle with all the electronic keys provided with your vehicle to your Toyota dealer.

**Locking and unlocking the doors**

Use the mechanical key (→P.107) in order to perform the

following operations.

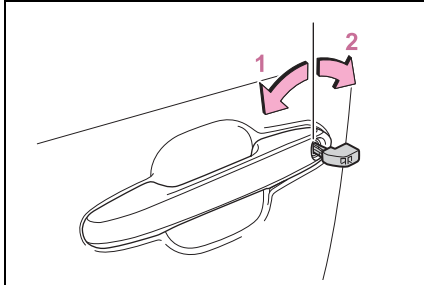

- 1 Locks all the doors
- 2 Unlocks the door

Turning the key rearward unlocks the driver's door. Turning the key once again within 5 seconds unlocks the other doors.

■ Key linked functions

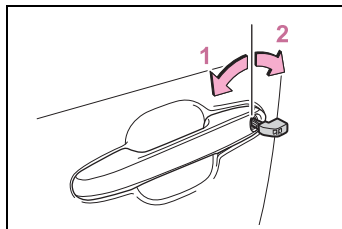

- 1 Closes the windows and the moon roof\*1 or panoramic moon roof\*1 (turn and hold)\*2
- 2 Opens the windows and the moon roof\*1 or panoramic moon roof\*1 (turn and hold)\*2

\*1: If equipped

\*2: These settings must be customized at your Toyota dealer.

**⚠ WARNING**

■ When using the mechanical key and operating the power windows or the moon roof (if equipped) or panoramic moon roof (if equipped)

Operate the power window or the moon roof or panoramic moon roof after checking to make sure that there is no possibility of any passenger having any of their body parts caught in the window or the moon roof or panoramic moon roof. Also, do not allow children to operate the mechanical key. It is possible for children and other passengers to get caught in the power window or the moon roof or panoramic moon roof.

**Starting the engine**

- 1 Ensure that the shift lever is in P and depress the brake pedal.
- 2 Touch the Toyota emblem side of the electronic key to the engine switch.

When the electronic key is detected, a buzzer sounds and the engine switch will turn to ON.

When the smart key system is deactivated in customization setting, the engine switch will turn to ACC.

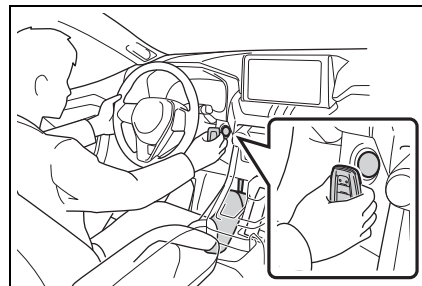

- 3 Firmly depress the brake pedal and check that  is displayed on the multi-information display.

- 4 Press the engine switch shortly and firmly.

In the event that the engine still cannot be started, contact your Toyota dealer.

**■ Stopping the engine**

Shift the shift lever to P, set the parking brake and press the engine switch as you normally do when stopping the engine.

**■ Replacing the key battery**

As the above procedure is a temporary measure, it is recommended that the electronic key battery be replaced immediately when the battery is depleted. (→P.604)

**■ Alarm (if equipped)**

Using the mechanical key to lock the doors will not set the alarm system.

If a door is unlocked using the mechanical key when the alarm system is set, the alarm may be triggered. (→P.73)

**■ Changing engine switch modes**

Release the brake pedal and press the engine switch in step 3 above. The engine does not start and modes will be changed each time the switch is pressed. (→P.197)

**If the vehicle battery is discharged**

**The following procedures may be used to start the engine if the vehicle's battery is discharged. You can also call your Toyota dealer or a qualified repair shop.**

**Restarting the engine**

If you have a set of jumper (or booster) cables and a second vehicle with a 12-volt battery, you can jump start your vehicle by following the steps below.

- 1 Vehicles with alarm: Confirm that the electronic key is being carried.

When connecting the jumper (or booster) cables, depending on the situation, the alarm may activate and the doors locked. (→P.74)

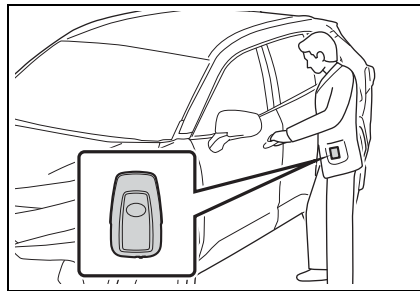

- 2 Open the hood. (→P.571)

- 3 Connect a positive jumper cable clamp to **A** on your vehicle and connect the clamp on the other end of the positive cable to **B** on the second vehicle. Then, connect a negative cable clamp to **C** on the second vehicle and connect the clamp at the other end of the negative cable to **D**.

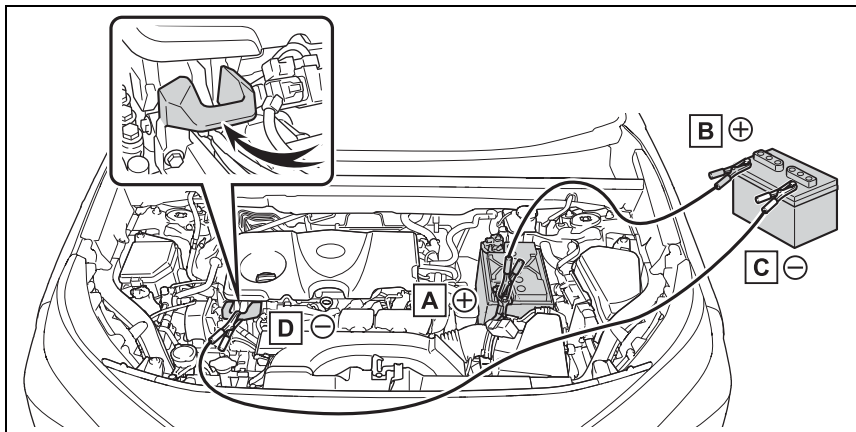

- A** Positive (+) battery terminal (your vehicle)
  - B** Positive (+) battery terminal (second vehicle)
  - C** Negative (-) battery terminal (second vehicle)
  - D** Solid, stationary, unpainted metallic point away from the battery and any moving parts as shown in the illustration
- 4 Start the engine of the second vehicle. Increase the engine speed slightly and maintain at that level for approximately 5 minutes to recharge the battery of your vehicle.
    - speed of the second vehicle and start the engine of your vehicle.
    - Vehicles with smart key system: Maintain the engine speed of the second vehicle and start the engine of your vehicle by turning the engine switch to ON.
  - 5 Vehicles with smart key system only: Open and close any of the doors of your vehicle with the engine switch OFF.
  - 6 Vehicles without smart key system: Maintain the engine
    - 7 Once the vehicle's engine has started, remove the jumper cables in the exact reverse order from which they were connected.



Once the engine starts, have the vehicle inspected at your Toyota dealer as soon as possible.

#### ■ Starting the engine when the battery is discharged

The engine cannot be started by push-starting.

#### ■ To prevent battery discharge

- Turn off the headlights and the audio system while the engine is stopped.

(Vehicles with Stop & Start system: Except when the engine is stopped due to the Stop & Start system)

- Turn off any unnecessary electrical components when the vehicle is running at a low speed for an extended period, such as in heavy traffic.

#### ■ When the battery is removed or discharged

- Information stored in the ECU is cleared. When the battery is depleted, have the vehicle inspected at your Toyota dealer.
- Some systems may require initialization. (→P.699)

#### ■ When removing the battery terminals

When the battery terminals are removed, the information stored in the ECU is cleared. Before removing the battery terminals, contact your Toyota dealer.

#### ■ Charging the battery

The electricity stored in the battery will discharge gradually even when the vehicle is not in use, due to natural discharge and the draining effects of certain electrical appliances. If the vehicle is left for a long time, the battery may discharge, and the engine may be unable to start. (The battery recharges automatically during driving.)

#### ■ When recharging or replacing the battery (vehicles without smart key start system)

The engine may not start on the first attempt after the battery has recharged but will start normally after the second attempt. This is not a malfunction.

#### ■ When recharging or replacing the battery (vehicles with smart key system)

- In some cases, it may not be possible to unlock the doors using the smart key system when the battery is discharged. Use the wireless remote control or the mechanical key to lock or unlock the doors.
- The engine may not start on the first attempt after the battery has recharged but will start normally after the second attempt. This is not a malfunction.
- The engine switch mode is memorized by the vehicle. When the battery is reconnected, the system will return to the mode it was in before the battery was discharged. Before disconnecting the battery, turn the engine switch off. If you are unsure what mode the engine switch was in before the battery discharged, be especially careful when reconnecting the battery.

#### ■ When the battery is removed or discharged (vehicles with Stop & Start system)

The Stop & Start system may not automatically stop the engine for up to an hour.

#### ■ When replacing the battery

- Vehicles with Stop & Start system: Use a genuine battery specifically designed for use with the Stop & Start system or a battery with equivalent specifications to a genuine battery. If an unsupported battery is used, Stop & Start system functions may be restricted to protect the bat-

tery. Also, battery performance may decrease and the engine may not be able to restart. Contact your Toyota dealer for details.

- Use a battery that conforms to European regulations.
- Type A:

Use a battery that the case size is same as the previous one (LN3), 20 hours rate capacity (20HR) is equivalent (65Ah) or greater, and performance rating (CCA) is equivalent (603A) or greater.

Type B:

Use a battery that the case size is same as the previous one (LN2), 20 hours rate capacity (20HR) is equivalent (60Ah) or greater, and performance rating (CCA) is equivalent (560A) or greater.

Type C:

Use a battery that the case size is same as the previous one (LN2), 20 hours rate capacity (20HR) is equivalent (60Ah) or greater, and performance rating (CCA) is equivalent (563A) or greater.

- If the sizes differ, the battery cannot be properly secured.
- If the 20 hour rate capacity is low, even if the time period where the vehicle is not used is a short time, the battery may discharge and engine may not be able to start.



#### WARNING

##### ■ When removing the battery terminals

Always remove the negative (-) terminal first. If the positive (+) terminal contacts any metal in the surrounding area when the positive (+) terminal is removed, a spark may occur, leading to a fire in addition to electrical shocks and death or serious injury.

##### ■ Avoiding battery fires or explosions

Observe the following precautions to prevent accidentally igniting the flammable gas that may be emitted from the battery:

- Make sure each jumper cable is connected to the correct terminal and that it is not unintentionally in contact with any other than the intended terminal.
- Do not allow the other end of the jumper cable connected to the "+" terminal to come into contact with any other parts or metal surfaces in the area, such as brackets or unpainted metal.
- Do not allow the + and - clamps of the jumper cables to come into contact with each other.
- Do not smoke, use matches, cigarette lighters or allow open flame near the battery.

##### ■ Battery precautions

The battery contains poisonous and corrosive acidic electrolyte, while related parts contain lead and lead compounds. Observe the following precautions when handling the battery:

- When working with the battery, always wear safety glasses and take care not to allow any battery fluids (acid) to come into contact with skin, clothing or the vehicle body.
- Do not lean over the battery.
- In the event that battery fluid comes into contact with the skin or eyes, immediately wash the affected area with water and seek medical attention. Place a wet sponge or cloth over the affected area until medical attention can be received.

**⚠ WARNING**

- Always wash your hands after handling the battery support, terminals, and other battery-related parts.
- Do not allow children near the battery.
- **When replacing the battery**  
For information regarding battery replacement, contact your Toyota dealer.

**⚠ NOTICE**

- **When handling jumper cables**  
When connecting the jumper cables, ensure that they do not become entangled in the cooling fan or engine drive belt.

**If your vehicle overheats****The following may indicate that your vehicle is overheating.**

- The needle of the engine coolant temperature gauge (→P.82, 85) enters the red zone or a loss of engine power is experienced. (For example, the vehicle speed does not increase.)
- “Engine Coolant Temp High Stop in a Safe Place See Owner’s Manual” is shown on the multi-information display.
- Steam comes out from under the hood.

**Correction procedures**

- 1 Stop the vehicle in a safe place and turn off the air conditioning system, and then stop the engine.
- 2 If you see steam:  
Carefully lift the hood after the steam subsides.  
If you do not see steam:  
Carefully lift the hood.

- 3 After the engine has cooled down sufficiently, inspect the hoses and radiator core (radiator) for any leaks.

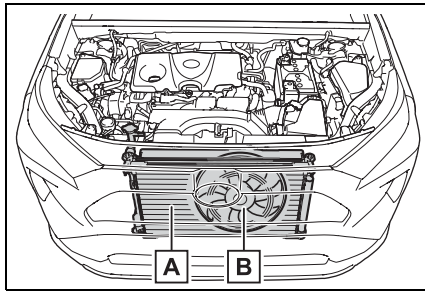

**A** Radiator

**B** Cooling fan

If a large amount of coolant leaks, immediately contact your Toyota dealer.

- 4 The coolant level is satisfactory if it is between the “FULL” and “LOW” lines on the reservoir.

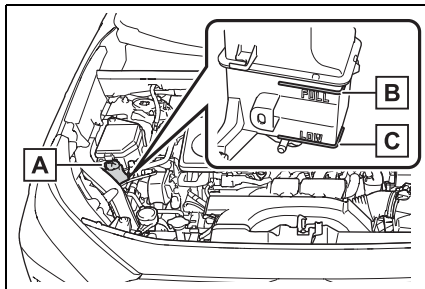

**A** Reservoir

**B** “FULL” line

**C** “LOW” line

- 5 Add coolant if necessary. Water can be used in an emer-

gency if coolant is unavailable.

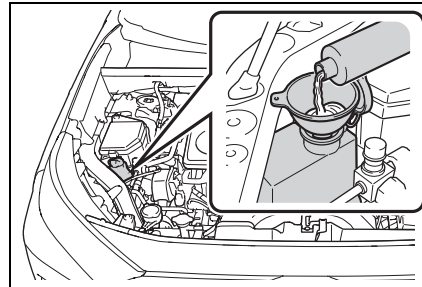

- 6 Start the engine and turn the air conditioning system on to check that the radiator cooling fan operates and to check for coolant leaks from the radiator or hoses.

The fan operates when the air conditioning system is turned on immediately after a cold start. Confirm that the fan is operating by checking the fan sound and air flow. If it is difficult to check these, turn the air conditioning system on and off repeatedly. (The fan may not operate in freezing temperatures.)

- 7 If the fan is not operating:  
Stop the engine immediately and contact your Toyota dealer.  
If the fan is operating:  
Have the vehicle inspected at the nearest Toyota dealer.
- 8 Check if “Engine Coolant Temp High Stop in a Safe Place See Owner’s Manual” is shown on the multi-information display.

If the message does not disappear:  
Stop the engine and contact your Toyota dealer.

If the message is not displayed:  
Have the vehicle inspected at the nearest Toyota dealer.

**⚠ WARNING****■ When inspecting under the hood of your vehicle**

Observe the following precautions.

Failure to do so may result in serious injury such as burns.

- If steam is seen coming from under the hood, do not open the hood until the steam has subsided. The engine compartment may be very hot.
- Keep hands and clothing (especially a tie, a scarf or a muffler) away from the fan and belts. Failure to do so may cause the hands or clothing to be caught, resulting in serious injury.
- Do not loosen the coolant reservoir cap while the engine and radiator are hot. High temperature steam or coolant could spray out.

**⚠ NOTICE****■ When adding engine coolant**

Add coolant slowly after the engine has cooled down sufficiently. Adding cool coolant to a hot engine too quickly can cause damage to the engine.

**■ To prevent damage to the cooling system**

Observe the following precautions:

- Avoid contaminating the coolant with foreign matter (such as sand or dust etc.).
- Do not use any coolant additive.

**If the vehicle becomes stuck****Carry out the following procedures if the tires spin or the vehicle becomes stuck in mud, dirt or snow:****Recovering procedure**

- 1 Stop the engine. Set the parking brake and shift the shift lever to P.
- 2 Remove the mud, snow or sand from around the stuck tire.
- 3 Place wood, stones or some other material to help provide traction under the tires.
- 4 Restart the engine.
- 5 Shift the shift lever to D or R and release the parking brake. Then, while exercising caution, depress the accelerator pedal.

**■ When it is difficult to free the vehicle**

Press  to turn off TRAC.  
(→P.361)

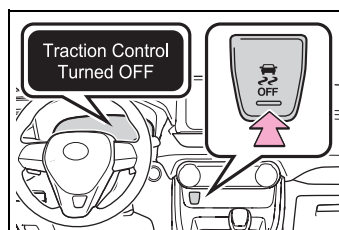



**WARNING**

■ **When attempting to free a stuck vehicle**

If you choose to push the vehicle back and forth to free it, make sure the surrounding area is clear to avoid striking other vehicles, objects or people. The vehicle may also lunge forward or lunge back suddenly as it becomes free. Use extreme caution.

■ **When shifting the shift lever**

Be careful not to shift the shift lever with the accelerator pedal depressed.

This may lead to unexpected rapid acceleration of the vehicle that may cause an accident resulting in death or serious injury.



**NOTICE**

■ **To avoid damaging the transmission and other components**

- Avoid spinning the wheels and depressing the accelerator pedal more than necessary.
- If the vehicle remains stuck even after these procedures are performed, the vehicle may require towing to be freed.

## Vehicle specifications

9

663

### 9-1. Specifications

- Maintenance data (fuel, oil level, etc.)..... 664
- Fuel information ..... 676
- Tire information ..... 678

### 9-2. Customization

- Customizable features 688

### 9-3. Initialization

- Items to initialize ..... 699

9

Vehicle specifications

## Maintenance data (fuel, oil level, etc.)

## Dimensions and weights

Overall length <sup>*1</sup>	Except ADVENTURE grade (for the U.S.A.)/Trail grade (for Canada)	180.9 in. (4595 mm)
	ADVENTURE grade (for the U.S.A.)/Trail grade (for Canada)	181.5 in. (4611 mm)
Overall width <sup>*1</sup>	Except ADVENTURE grade (for the U.S.A.)/Trail grade (for Canada)	73.0 in. (1855 mm)
	ADVENTURE grade (for the U.S.A.)/Trail grade (for Canada)	73.4 in. (1865 mm)
Overall height <sup>*1</sup>	Without bridge type roof rail	67.0 in. (1701 mm) <sup>*2</sup> 67.2 in. (1706 mm) <sup>*3</sup>
	With bridge type roof rail	68.6 in. (1742 mm)
Wheelbase <sup>*1</sup>		105.9 in. (2690 mm)
Tread <sup>*1</sup>	Front	63.0 in. (1600 mm) <sup>*2</sup> 62.6 in. (1590 mm) <sup>*3</sup>
	Rear	63.7 in. (1619 mm) <sup>*2</sup> 63.3 in. (1609 mm) <sup>*3</sup>



Vehicle capacity weight (Occupants + luggage)	900 lb. (410 kg)
Trailer Weight Rating (Trailer weight + cargo weight)	1500 lb. (680 kg) <sup>*4</sup> 3500 lb. (1590 kg) <sup>*5</sup>

- \*1: Unladen vehicle
- \*2: Vehicles without 235/55R19 tires
- \*3: Vehicles with 235/55R19 tires
- \*4: Vehicles without towing package
- \*5: Vehicles with towing package

### Vehicle identification

#### ■ Vehicle identification number

The vehicle identification number (VIN) is the legal identifier for your vehicle. This is the primary identification number for your Toyota. It is used in registering the ownership of your vehicle.

This number is stamped on the top left of the instrument panel.

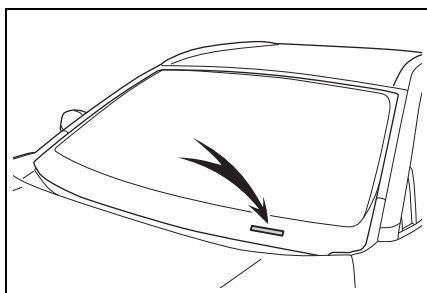

On some models, this number is also stamped under the right-hand front seat.

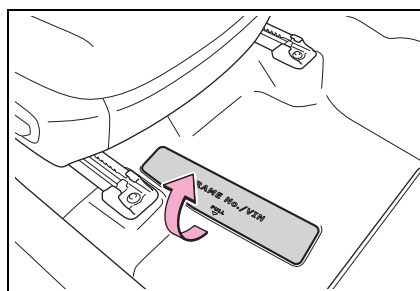

This number is also on the Certification Regulation Label.

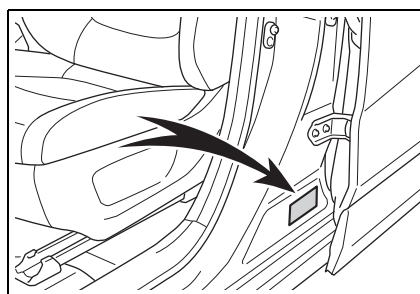

#### ■ Engine number

The engine number is stamped on the engine block as shown.

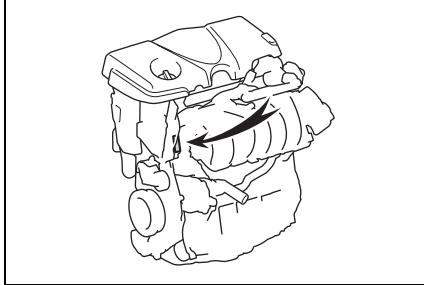

### Engine

Model	A25A-FKS
Type	4-cylinder in line, 4-cycle, gasoline
Bore and stroke	3.44 × 4.07 in. (87.5 × 103.4 mm)
Displacement	151.8 cu. in. (2487 cm <sup>3</sup> )
Valve clearance	Automatic adjustment
Drive belt tension	Automatic adjustment

### Fuel

Fuel type	Unleaded gasoline only
Octane Rating	87 (Research Octane Number 91) or higher
Fuel tank capacity (Reference)	14.5 gal. (55 L, 12.1 Imp.gal.)

### Lubrication system

#### ■ Oil capacity (Drain and refill — reference<sup>\*</sup>)

With filter	4.8 qt. (4.5 L, 4.0 Imp. qt.)
Without filter	4.4 qt. (4.2 L, 3.7 Imp. qt.)

<sup>\*</sup>: The engine oil capacity is a reference quantity to be used when changing the engine oil. Warm up and turn off the engine, wait more than 5 minutes, and check the oil level on the dipstick.

■ **Engine oil selection** used in your Toyota vehicle. Use  
 “Toyota Genuine Motor Oil” is Toyota approved “Toyota Genu-

ine Motor Oil” or equivalent to satisfy the following grade and viscosity.

Oil grade:  
API SN/RC multigrade engine oil

Recommended viscosity:  
SAE 0W-16

SAE 0W-16 is the best choice for good fuel economy and good starting in cold weather.

If SAE 0W-16 is not available, SAE 0W-20 oil may be used. However, it must be replaced with SAE 0W-16 at the next oil change.

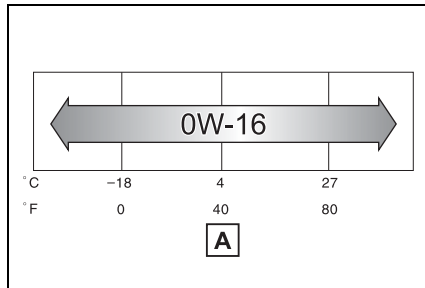

**A** Outside temperature

Oil viscosity (0W-16 is explained here as an example):

- The 0W in 0W-16 indicates the characteristic of the oil which allows cold startability. Oils with a lower value before the W allow for easier starting of the engine in cold weather.
- The 16 in 0W-16 indicates the viscosity characteristic of the oil when the oil is at high temperature. An oil with a higher

viscosity (one with a higher value) may be better suited if the vehicle is operated at high speeds, or under extreme load conditions.

How to read oil container label:

API registered mark is added to some oil containers to help you select the oil you should use.



**Cooling system**

Capacity*	Without engine oil cooler	7.3 qt. (6.9 L, 6.1 Imp. qt.)
	With engine oil cooler	7.4 qt. (7.0 L, 6.2 Imp. qt.)
Coolant type		Use either of the following: <ul style="list-style-type: none"> <li>• “Toyota Super Long Life Coolant”</li> <li>• Similar high-quality ethylene glycol-based non-silicate, non-amine, non-nitrite, and non-borate coolant with long-life hybrid organic acid technology</li> </ul> Do not use plain water alone.

\*: The coolant capacity is the quantity of reference.  
If replacement is necessary, contact your Toyota dealer.

**Ignition system (spark plug)**

Make	DENSO FC16HR-Q8
Gap	0.031 in. (0.8 mm)

 NOTICE

**■ Iridium-tipped spark plugs**

Use only iridium-tipped spark plugs. Do not adjust the spark plug gap.

**Electrical system (battery)**

Specific voltage reading at 68°F (20°C):	12.3 V or higher (Turn the engine switch to OFF and turn on the high beam headlights for 30 seconds.) If the voltage is lower than the standard value, charge the battery.	
Charging rates	Quick charge	15 A max.
	Slow charge	5 A max.

**Automatic transmission**

Fluid capacity *	7.8 qt. (7.4 L, 6.5 Imp.qt.)
Fluid type	Toyota Genuine ATF WS

\*: The fluid capacity is the quantity of reference.  
If replacement is necessary, contact your Toyota dealer.

 NOTICE

**Automatic transmission fluid type**  
Using transmission fluid other than the above type may cause abnormal noise or vibration, or damage the transmission of your vehicle.

**Transfer (Dynamic Torque Control AWD vehicle)**

Oil capacity	0.48 qt. (0.45 L, 0.40 Imp.qt.)
Oil type and viscosity	Toyota Genuine Differential gear oil LX 75W-85 GL-5 or equivalent

Your Toyota vehicle is filled with “Toyota Genuine Differential Gear Oil” at the factory.

Use Toyota approved “Toyota Genuine Differential Gear Oil” or an equivalent of matching quality to satisfy the above specification.  
Please contact your Toyota dealer for further details.

**Transfer (Dynamic Torque Vectoring AWD vehicle)**

Oil capacity	0.409 qt. (0.387 L, 0.341 Imp.qt.)
Oil type	Toyota Genuine Differential gear oil LX

 NOTICE

**Transfer oil type precaution**  
Using transfer oil other than the specified oil may cause abnormal noise or vibration, or damage the transfer of your vehicle.

**Rear differential (Dynamic Torque Control AWD vehicle)**

Oil capacity	0.5 qt. (0.5 L, 0.4 Imp.qt.)
Oil type and viscosity	Toyota Genuine Differential gear oil LX 75W-85 GL-5 or equivalent

Your Toyota vehicle is filled with “Toyota Genuine Differential Gear Oil” at the factory.

Use Toyota approved “Toyota Genuine Differential Gear Oil” or an equivalent of matching quality to satisfy the above specification. Please contact your Toyota dealer for further details.

**Rear differential (Dynamic Torque Vectoring AWD vehicle)**

Oil capacity	0.553 qt. (0.523 L, 0.460 Imp.qt.)
Oil type	Toyota Genuine Differential gear oil LX

**NOTICE****■ Differential gear oil type precaution**

Using differential gear oil other than the specified oil may cause abnormal noise or vibration, or damage the differential gear of your vehicle.

**Brakes**

Pedal clearance*	5.1 in. (129 mm) Min.
Pedal free play	0.04 — 0.24 in. (1.0 — 6.0 mm)
Brake pad wear limit	0.04 in. (1.0 mm)
Fluid type	FMVSS No.116 DOT 3 or SAE J1703 FMVSS No.116 DOT 4 or SAE J1704

\*: Minimum pedal clearance when depressed with a force of 300 N (30.5 kgf, 67.4 lbf) while the engine is running.

**Steering**

Free play	Less than 1.2 in. (30 mm)
-----------	---------------------------

**Tires and wheels**

► Vehicles with 17-inch wheels (type A)

Tire size	225/65R17 102H, T165/80R17 104M (spare)
Tire inflation pressure (Recommended cold tire inflation pressure)	Front: 35 psi (240 kPa, 2.4 kgf/cm <sup>2</sup> or bar) Rear: 35 psi (240 kPa, 2.4 kgf/cm <sup>2</sup> or bar) Spare: 60 psi (420 kPa, 4.2 kgf/cm <sup>2</sup> or bar)
Wheel size	17 × 7J, 17 × 4T (spare)
Wheel nut torque	76 ft•lbf (103 N•m, 10.5 kgf•m)

► Vehicles with 17-inch wheels (type B)

Tire size	225/65R17 102H, T165/80R17 104M (spare)
Tire inflation pressure (Recommended cold tire inflation pressure)	Front: 36 psi (250 kPa, 2.5 kgf/cm <sup>2</sup> or bar) Rear: 36 psi (250 kPa, 2.5 kgf/cm <sup>2</sup> or bar) Spare: 60 psi (420 kPa, 4.2 kgf/cm <sup>2</sup> or bar)
Wheel size	17 × 7J, 17 × 4T (spare)
Wheel nut torque	76 ft•lbf (103 N•m, 10.5 kgf•m)

## ► Vehicles with 17-inch wheels (type C)

Tire size	225/65R17 102H, T165/80D17 104M (spare)
Tire inflation pressure (Recommended cold tire inflation pressure)	Front: 33 psi (230 kPa, 2.3 kgf/cm <sup>2</sup> or bar) Rear: 33 psi (230 kPa, 2.3 kgf/cm <sup>2</sup> or bar) Spare: 60 psi (420 kPa, 4.2 kgf/cm <sup>2</sup> or bar)
Wheel size	17 × 7J, 17 × 4T (spare)
Wheel nut torque	76 ft•lbf (103 N•m, 10.5 kgf•m)

## ► Vehicles with 17-inch wheels (type D)

Tire size	225/65R17 102H, T165/80D17 104M (spare)
Tire inflation pressure (Recommended cold tire inflation pressure)	Front: 35 psi (240 kPa, 2.4 kgf/cm <sup>2</sup> or bar) Rear: 35 psi (240 kPa, 2.4 kgf/cm <sup>2</sup> or bar) Spare: 60 psi (420 kPa, 4.2 kgf/cm <sup>2</sup> or bar)
Wheel size	17 × 7J, 17 × 4T (spare)
Wheel nut torque	76 ft•lbf (103 N•m, 10.5 kgf•m)



► Vehicles with 17-inch wheels (type E)

Tire size	225/65R17 102H, T165/80D17 104M (spare)
Tire inflation pressure (Recommended cold tire inflation pressure)	Front: 36 psi (250 kPa, 2.5 kgf/cm <sup>2</sup> or bar) Rear: 36 psi (250 kPa, 2.5 kgf/cm <sup>2</sup> or bar) Spare: 60 psi (420 kPa, 4.2 kgf/cm <sup>2</sup> or bar)
Wheel size	17 × 7J, 17 × 4T (spare)
Wheel nut torque	76 ft•lbf (103 N•m, 10.5 kgf•m)

► Vehicles with 18-inch wheels

Tire size	225/60R18 100H, T165/80D17 104M (spare)
Tire inflation pressure (Recommended cold tire inflation pressure)	Front: 33 psi (230 kPa, 2.3 kgf/cm <sup>2</sup> or bar) Rear: 33 psi (230 kPa, 2.3 kgf/cm <sup>2</sup> or bar) Spare: 60 psi (420 kPa, 4.2 kgf/cm <sup>2</sup> or bar)
Wheel size	18 × 7J, 18 × 4T (spare)
Wheel nut torque	76 ft•lbf (103 N•m, 10.5 kgf•m)

## ► Vehicles with 19-inch wheels (type A)

Tire size	235/55R19 101V, T165/90D18 107M (spare)
Tire inflation pressure (Recommended cold tire inflation pressure)	Front: 33 psi (230 kPa, 2.3 kgf/cm <sup>2</sup> or bar) Rear: 33 psi (230 kPa, 2.3 kgf/cm <sup>2</sup> or bar) Spare: 60 psi (420 kPa, 4.2 kgf/cm <sup>2</sup> or bar)
Wheel size	19 × 7 1/2J, 18 × 4T (spare)
Wheel nut torque	76 ft•lbf (103 N•m, 10.5 kgf•m)

## ► Vehicles with 19-inch wheels (type B)

Tire size	235/55R19 101V, T165/90D18 107M (spare)
Tire inflation pressure (Recommended cold tire inflation pressure)	Front: 35 psi (240 kPa, 2.4 kgf/cm <sup>2</sup> or bar) Rear: 35 psi (240 kPa, 2.4 kgf/cm <sup>2</sup> or bar) Spare: 60 psi (420 kPa, 4.2 kgf/cm <sup>2</sup> or bar)
Wheel size	19 × 7 1/2J, 18 × 4T (spare)
Wheel nut torque	76 ft•lbf (103 N•m, 10.5 kgf•m)

**Light bulbs**

Light bulbs		Bulb No.	W	Type
Exterior	Front side marker lights	W5W	5	A
	Fog lights *	—	19	B
	Front turn signal/parking lights (bulb type)	7444NA	28/8	C
	Rear turn signal lights	WY21W	21	C
	Back-up lights	W16W	16	A
	Outer foot lights *	—	5	A
Interior	Vanity lights	—	8	A
	Interior lights (front)/personal lights	—	5	A
	Interior light (rear)	—	8	D
	Luggage compartment light	—	5	A

A: Wedge base bulbs (clear)

B: H16 halogen bulbs

C: Wedge base bulbs (amber)

D: Double end bulbs (clear)

\*: If equipped

## Fuel information

**You must only use unleaded gasoline in your vehicle.**

**Select octane rating 87 (Research Octane Number 91) or higher. Use of unleaded gasoline with an octane rating lower than 87 may result in engine knocking. Persistent knocking can lead to engine damage.**

At minimum, the gasoline you use should meet the specifications of ASTM D4814 in the U.S.A..

### ■ Gasoline quality

In very few cases, driveability problems may be caused by the brand of gasoline you are using. If driveability problems persist, try changing the brand of gasoline. If this does not correct the problem, consult your Toyota dealer.

### ■ Recommendation of the use of gasoline containing detergent additives

- Toyota recommends the use of gasoline that contains detergent additives to avoid the build-up of engine deposits.
- All gasoline sold in the U.S.A. contains minimum detergent additives to clean and/or keep clean intake systems, per EPA's lowest additives concentration program.
- Toyota strongly recommends the use of Top Tier Detergent Gasoline. For more information on Top Tier Detergent Gasoline and a list of marketers, please go to the official website [www.toptiergas.com](http://www.toptiergas.com).

### ■ Recommendation of the use of low emissions gasoline

Gasolines containing oxygenates such as ethers and ethanol, as well as reformulated gasolines, are available in some cities. These fuels are typically acceptable for use, providing they meet other fuel requirements.

Toyota recommends these fuels, since the formulations allow for reduced vehicle emissions.

### ■ Non-recommendation of the use of blended gasoline

- Use only gasoline containing up to 15% ethanol.  
DO NOT use any flex-fuel or gasoline that could contain more than 15% ethanol, including from any pump labeled E30 (30% ethanol **A**), E50 (50% ethanol **B**), E85 (85% ethanol **C**) (which are only some examples of fuel containing more than 15% ethanol).

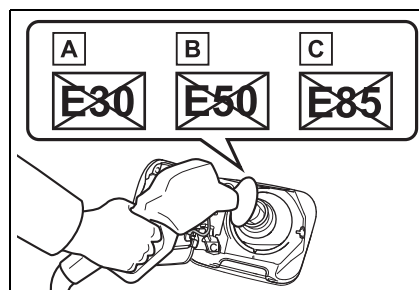

- If you use gasohol in your vehicle, be sure that it has an octane rating no lower than 87.
- Toyota does not recommend the use of gasoline containing methanol.

### ■ Non-recommendation of the use of gasoline containing MMT

Some gasoline contains an octane enhancing additive called MMT (Methylcyclopentadienyl Manganese Tricarbonyl).

Toyota does not recommend the use

of gasoline that contains MMT. If fuel containing MMT is used, your emission control system may be adversely affected.

The malfunction indicator lamp on the instrument cluster may come on. If this happens, contact your Toyota dealer for service.

#### ■ If your engine knocks

- Consult your Toyota dealer.
- You may occasionally notice light knocking for a short time while accelerating or driving uphill. This is normal and there is no need for concern.



#### NOTICE

##### ■ Notice on fuel quality

- Do not use improper fuels. If improper fuels are used, the engine will be damaged.
- Do not use leaded gasoline. Leaded gasoline can cause damage to your vehicle's three-way catalytic converters causing the emission control system to malfunction.
- Do not use gasohol other than the type previously stated. Other gasohol may cause fuel system damage or vehicle performance problems.
- Using unleaded gasoline with an octane number or rating lower than the level previously stated will cause persistent heavy knocking. At worst, this will lead to engine damage.

##### ■ Fuel-related poor driveability

If poor driveability (poor hot starting, vaporization, engine knocking, etc.) is encountered after using a different type of fuel, discontinue the use of that type of fuel.

##### ■ When refueling with gasohol

Take care not to spill gasohol. It can damage your vehicle's paint.

Tire information

Typical tire symbols

► Full-size tire

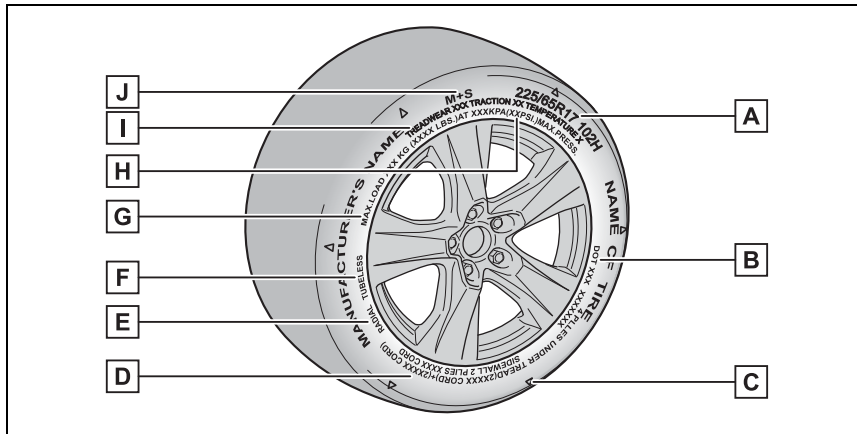

► Compact spare tire

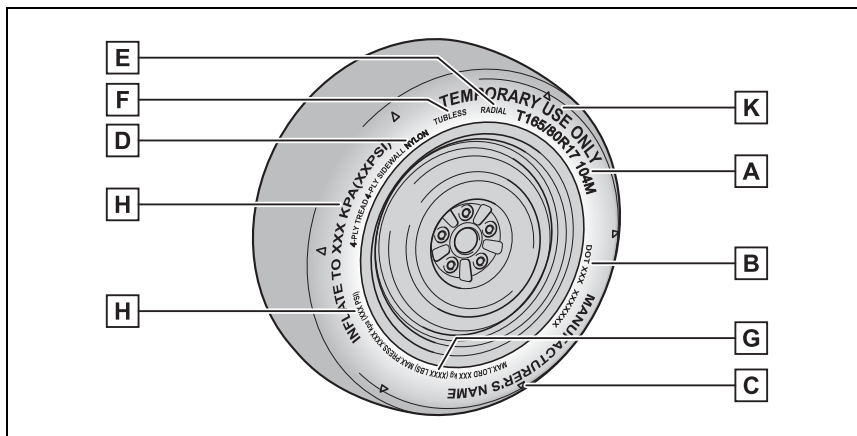

- A** Tire size (→P.680)
- B** DOT and Tire Identification Number (TIN) (→P.679)
- C** Location of treadwear indicators (→P.581)
- D** Tire ply composition and materials

Plies are layers of rubber-coated parallel cords. Cords are the strands which form the plies in a tire.

**E** Radial tires or bias-ply tires

A radial tire has "RADIAL" on the sidewall. A tire not marked "RADIAL" is a bias-ply tire.

**F** TUBELESS or TUBE TYPE

A tubeless tire does not have a tube and air is directly put into the tire. A tube type tire has a tube inside the tire and the tube maintains the air pressure.

**G** Load limit at maximum cold tire inflation pressure (→P.682)

**H** Maximum cold tire inflation pressure (→P.670)

This means the pressure to which a tire may be inflated.

**I** Uniform tire quality grading

For details, see "Uniform Tire Quality Grading" that follows.

**J** Summer tires or all season tires (→P.582)

An all season tire has "M+S" on the sidewall. A tire not marked "M+S" is a summer tire.

**K** "TEMPORARY USE ONLY"

A compact spare tire is identified by the phrase "TEMPORARY USE ONLY" molded on its sidewall. This tire is designed for temporary emergency use only.

**Typical DOT and Tire Identification Number (TIN)**

► Type A

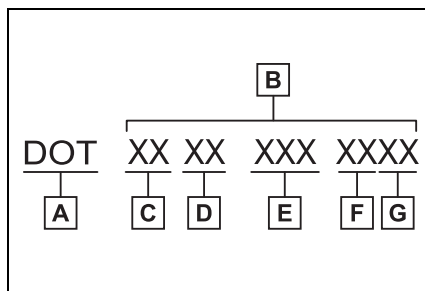

**A** DOT symbol\*

**B** Tire Identification Number (TIN)

**C** Tire manufacturer's identification mark

**D** Tire size code

**E** Manufacturer's optional tire type code (3 or 4 letters)

**F** Manufacturing week

**G** Manufacturing year

\*: The DOT symbol certifies that the tire conforms to applicable Federal Motor Vehicle Safety Standards.

► Type B

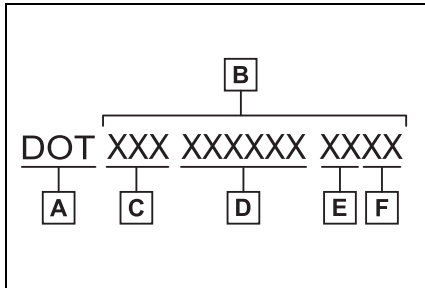

- A** DOT symbol\*
- B** Tire Identification Number (TIN)
- C** Tire manufacturer's identification mark
- D** Manufacturer's code
- E** Manufacturing week
- F** Manufacturing year

\*: The DOT symbol certifies that the tire conforms to applicable Federal Motor Vehicle Safety Standards.

**Tire size**

■ Typical tire size information

The illustration indicates typical tire size.

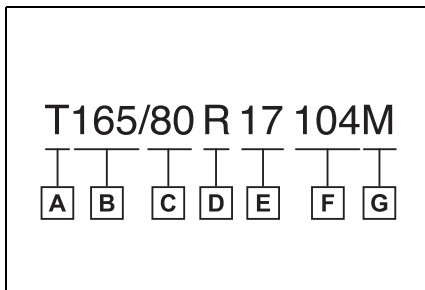

- A** Tire use

(P = Passenger car,  
T = Temporary use)

- B** Section width (millimeters)
- C** Aspect ratio (tire height to section width)
- D** Tire construction code (R = Radial, D = Diagonal)
- E** Wheel diameter (inches)
- F** Load index (2 digits or 3 digits)
- G** Speed symbol (alphabet with one letter)

■ Tire dimensions

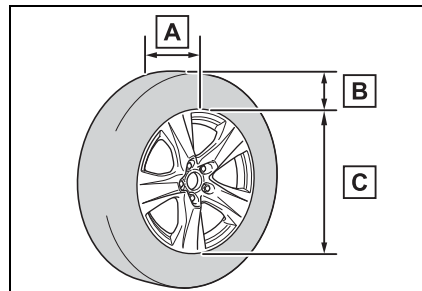

- A** Section width
- B** Tire height
- C** Wheel diameter

**Tire section names**

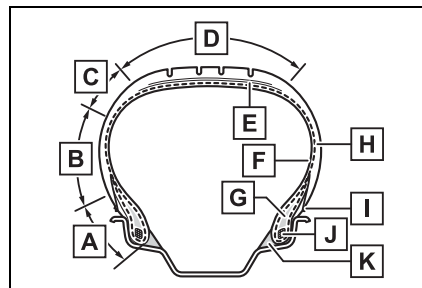



- A** Bead
- B** Sidewall
- C** Shoulder
- D** Tread
- E** Belt
- F** Inner liner
- G** Reinforcing rubber
- H** Carcass
- I** Rim lines
- J** Bead wires
- K** Chafer

### Uniform Tire Quality Grading

This information has been prepared in accordance with regulations issued by the National Highway Traffic Safety Administration of the U.S. Department of Transportation.

It provides the purchasers and/or prospective purchasers of Toyota vehicles with information on uniform tire quality grading.

Your Toyota dealer will help answer any questions you may have as you read this information.

#### ■ DOT quality grades

All passenger vehicle tires must conform to Federal Safety Requirements in addition to these grades. Quality grades can be found where applicable

on the tire sidewall between tread shoulder and maximum section width.

For example: Treadwear 200 Traction AA Temperature A

#### ■ Treadwear

The treadwear grade is a comparative rating based on the wear rate of the tire when tested under controlled conditions on a specified government test course.

For example, a tire graded 150 would wear one and a half (1 - 1/2) times as well on the government course as a tire graded 100.

The relative performance of tires depends upon the actual conditions of their use. Performance may differ significantly from the norm due to variations in driving habits, service practices and differences in road characteristics and climate.

#### ■ Traction AA, A, B, C

The traction grades, from highest to lowest, are AA, A, B and C, and they represent the tire's ability to stop on wet pavement as measured under controlled conditions on specified government test surfaces of asphalt and concrete.

A tire marked C may have poor traction performance.

Warning: The traction grade assigned to this tire is based on braking (straight ahead) traction tests and does not include cornering (turning) traction.

### ■ Temperature A, B, C

The temperature grades are A (the highest), B, and C, representing the tire's resistance to the generation of heat and its ability to dissipate heat when tested under controlled conditions on a specified indoor laboratory test wheel.

Sustained high temperature can cause the material of the tire to degenerate and reduce tire life, and excessive temperature can lead to sudden tire failure.

Grade C corresponds to a level of

performance which all passenger car tires must meet under the Federal Motor Vehicle Safety Standard No. 109.

Grades B and A represent higher levels of performance on the laboratory test wheel than the minimum required by law.

Warning: The temperature grades of a tire assume that it is properly inflated and not overloaded.

Excessive speed, underinflation, or excessive loading, either separately or in combination, can cause heat buildup and possible tire failure.

### Glossary of tire terminology

Tire related term	Meaning
Cold tire inflation pressure	Tire pressure when the vehicle has been parked for three hours or more, or has not been driven more than 1 mile or 1.5 km under that condition
Maximum inflation pressure	The maximum cold inflated pressure to which a tire may be inflated, shown on the sidewall of the tire
Recommended inflation pressure	Cold tire inflation pressure recommended by a manufacturer
Accessory weight	The combined weight (in excess of those standard items which may be replaced) of transmission, power steering, power brakes, power windows, power seats, radio and heater, to the extent that these items are available as factory-installed equipment (whether installed or not)
Curb weight	The weight of a motor vehicle with standard equipment, including the maximum capacity of fuel, oil and coolant, and if so equipped, air conditioning and additional weight optional engine

Tire related term	Meaning
Maximum loaded vehicle weight	The sum of: (a) Curb weight (b) Accessory weight (c) Vehicle capacity weight (d) Production options weight
Normal occupant weight	150 lb. (68 kg) times the number of occupants specified in the second column of Table 1* that follows
Occupant distribution	Distribution of occupants in a vehicle as specified in the third column of Table 1* below
Production options weight	The combined weight of installed regular production options weighing over 5 lb. (2.3 kg) in excess of the standard items which they replace, not previously considered in curb weight or accessory weight, including heavy duty brakes, ride levelers, roof rack, heavy duty battery, and special trim
Rim	A metal support for a tire or a tire and tube assembly upon which the tire beads are seated
Rim diameter (Wheel diameter)	Nominal diameter of the bead seat
Rim size designation	Rim diameter and width
Rim type designation	The industry manufacturer's designation for a rim by style or code
Rim width	Nominal distance between rim flanges
Vehicle capacity weight (Total load capacity)	The rated cargo and luggage load plus 150 lb. (68 kg) times the vehicle's designated seating capacity
Vehicle maximum load on the tire	The load on an individual tire that is determined by distributing to each axle its share of the maximum loaded vehicle weight, and dividing by two
Vehicle normal load on the tire	The load on an individual tire that is determined by distributing to each axle its share of curb weight, accessory weight, and normal occupant weight (distributed in accordance with Table 1* below), and dividing by two

Tire related term	Meaning
Weather side	The surface area of the rim not covered by the inflated tire
Bead	The part of the tire that is made of steel wires, wrapped or reinforced by ply cords and that is shaped to fit the rim
Bead separation	A breakdown of the bond between components in the bead
Bias ply tire	A pneumatic tire in which the ply cords that extend to the beads are laid at alternate angles substantially less than 90 degrees to the center-line of the tread
Carcass	The tire structure, except tread and sidewall rubber which, when inflated, bears the load
Chunking	The breaking away of pieces of the tread or sidewall
Cord	The strands forming the plies in the tire
Cord separation	The parting of cords from adjacent rubber compounds
Cracking	Any parting within the tread, sidewall, or innerliner of the tire extending to cord material
CT	A pneumatic tire with an inverted flange tire and rim system in which the rim is designed with rim flanges pointed radially inward and the tire is designed to fit on the underside of the rim in a manner that encloses the rim flanges inside the air cavity of the tire
Extra load tire	A tire designed to operate at higher loads and at higher inflation pressures than the corresponding standard tire
Groove	The space between two adjacent tread ribs
Innerliner	The layer(s) forming the inside surface of a tubeless tire that contains the inflating medium within the tire
Innerliner separation	The parting of the innerliner from cord material in the carcass

Tire related term	Meaning
Intended outboard sidewall	(a)The sidewall that contains a whitewall, bears white lettering, or bears manufacturer, brand, and/or model name molding that is higher or deeper than the same molding on the other sidewall of the tire, or (b)The outward facing sidewall of an asymmetrical tire that has a particular side that must always face outward when mounted on a vehicle
Light truck (LT) tire	A tire designated by its manufacturer as primarily intended for use on lightweight trucks or multipurpose passenger vehicles
Load rating	The maximum load that a tire is rated to carry for a given inflation pressure
Maximum load rating	The load rating for a tire at the maximum permissible inflation pressure for that tire
Maximum permissible inflation pressure	The maximum cold inflation pressure to which a tire may be inflated
Measuring rim	The rim on which a tire is fitted for physical dimension requirements
Open splice	Any parting at any junction of tread, sidewall, or innerliner that extends to cord material
Outer diameter	The overall diameter of an inflated new tire
Overall width	The linear distance between the exteriors of the sidewalls of an inflated tire, including elevations due to labeling, decorations, or protective bands or ribs
Passenger car tire	A tire intended for use on passenger cars, multipurpose passenger vehicles, and trucks, that have a gross vehicle weight rating (GVWR) of 10,000 lb. or less.
Ply	A layer of rubber-coated parallel cords
Ply separation	A parting of rubber compound between adjacent plies

Tire related term	Meaning
Pneumatic tire	A mechanical device made of rubber, chemicals, fabric and steel or other materials, that, when mounted on an automotive wheel, provides the traction and contains the gas or fluid that sustains the load
Radial ply tire	A pneumatic tire in which the ply cords that extend to the beads are laid at substantially 90 degrees to the centerline of the tread
Reinforced tire	A tire designed to operate at higher loads and at higher inflation pressures than the corresponding standard tire
Section width	The linear distance between the exteriors of the sidewalls of an inflated tire, excluding elevations due to labeling, decoration, or protective bands
Sidewall	That portion of a tire between the tread and bead
Sidewall separation	The parting of the rubber compound from the cord material in the sidewall
Snow tire	A tire that attains a traction index equal to or greater than 110, compared to the ASTM E-1136 Standard Reference Test Tire, when using the snow traction test as described in ASTM F-1805-00, Standard Test Method for Single Wheel Driving Traction in a Straight Line on Snow-and Ice-Covered Surfaces, and which is marked with an Alpine Symbol (  ) on at least one sidewall
Test rim	The rim on which a tire is fitted for testing, and may be any rim listed as appropriate for use with that tire
Tread	That portion of a tire that comes into contact with the road
Tread rib	A tread section running circumferentially around a tire
Tread separation	Pulling away of the tread from the tire carcass

Tire related term	Meaning
Treadwear indicators (TWI)	The projections within the principal grooves designed to give a visual indication of the degrees of wear of the tread
Wheel-holding fixture	The fixture used to hold the wheel and tire assembly securely during testing

\*: Table 1 — Occupant loading and distribution for vehicle normal load for various designated seating capacities

Designated seating capacity, Number of occupants	Vehicle normal load, Number of occupants	Occupant distribution in a normally loaded vehicle
2 through 4	2	2 in front
5 through 10	3	2 in front, 1 in second seat
11 through 15	5	2 in front, 1 in second seat, 1 in third seat, 1 in fourth seat
16 through 20	7	2 in front, 2 in second seat, 2 in third seat, 1 in fourth seat

### Customizable features

**Your vehicle includes a variety of electronic features that can be personalized to suit your preferences. The settings of these features can be changed using the multi-information display, navigation/multimedia system, or at your Toyota dealer.**







### Customizing vehicle features

#### ■ Changing using the navigation/multimedia system

- 1 Press the "MENU" button.
- 2 Select "Setup" on the menu screen and select "Vehicle".
- 3 Select "Vehicle Customization".

Various setting can be changed. Refer to the list of settings that can be changed for details.

#### ■ Changing using the multi-information display

- 1 Press  or  of the meter control switches and select .
- 2 Press  or  of the meter control switches, select the item.
- 3 To switch the function on and off, press  to switch to the desired setting.

- 4 To perform detailed setting of functions that support detailed settings, press and hold  and display the setting screen.

The method of performing detailed setting differs for each screen. Please refer to the advice sentence displayed on the screen.

To go back to the previous screen or exit the customize mode, press



#### ■ When customizing using the navigation/multimedia system or multi-information display

Stop the vehicle in a safe place, apply the parking brake, and shift the shift lever to P. Also, to prevent battery discharge, leave the engine running while customizing the features.

#### WARNING

##### ■ During customization

As the engine needs to be operating during customization, ensure that the vehicle is parked in a place with adequate ventilation. In a closed area such as a garage, exhaust gases including harmful carbon monoxide (CO) may collect and enter the vehicle. This may lead to death or a serious health hazard.

#### NOTICE

##### ■ During customization

To prevent battery discharge, ensure that the engine is running while customizing features.



### Customizable Features

Some function settings are changed simultaneously with other functions being customized. Contact your Toyota dealer for further details.

**A** Vehicles with navigation system or multimedia system: Settings that can be changed using the navigation system or multimedia system

**B** Settings that can be changed using the multi-information display

**C** Settings that can be changed by your Toyota dealer

Definition of symbols: O = Available, – =Not available

■ **Gauges, meters and multi-information display (→P.82, 85, 89)**

Function*1	Default setting	Customized setting	A	B	C
Language*2	"English" (English)	"Français canadien" (Canadian French)	O	O	–
		"Español mexicano" (Mexican Spanish)			
Units*2	miles (MPG US)	km (km/L)			
		km (L/100 km)	O	O	–
		miles (MPG Imperial)			
Speedometer display*3	Analog	Digital	–	O	–
Eco Driving Indicator Light	On	Off	–	O	–
"Fuel Economy"	"Total Average"	"Trip Average"	–	O	–
		"Tank Average"			
Audio system linked display	On	Off	–	O	–
AWD system display*4	On	Off	–	O	–
Drive information type	Trip	Total	–	O	–

Function <sup>*1</sup>	Default setting	Customized setting	A	B	C
Drive information items (first item)	Distance	Average Speed	-	O	-
		Total Time	-	O	-
Drive information items (second item)	Total Time	Average Speed	-	O	-
		Distance	-	O	-
Pop-up display	On	Off	-	O	-
Multi-Information display off	Off	On	-	O	-
Suggestion function	On	On (when the vehicle is stopped)	O	-	O
		Off	O	-	O

\*1: For details about each function: →P.94

\*2: The default setting varies according to country.

\*3: Vehicles with 7-inch display only

\*4: AWD models

#### ■ Door lock (→P.108, 653)

Function	Default setting	Customized setting	A	B	C
Unlocking using a key	Driver's door unlocked in first step, all doors unlocked in second step	All doors unlocked in first step	-	-	O
Automatic door locking function	Shift position linked door locking operation	Off	O	-	O
		Speed linked door locking operation	O	-	O

Function	Default setting	Customized setting	A	B	C
Automatic door unlocking function	Shift position linked door unlocking operation	Off			
		Driver's door linked door unlocking operation	O	-	O

■ Smart key system\* and wireless remote control (→P.104, 128)

Function	Default setting	Customized setting	A	B	C
Operation signal (emergency flashers)	On	Off	O	-	O
Operation buzzer volume	5	Off	O	-	O
		1 to 7			
Time elapsed before the automatic door lock function is activated if a door is not opened after being unlocked	60 seconds	Off			
		30 seconds	O	-	O
		120 seconds			
Open door reminder buzzer (When locking the vehicle)	On	Off	-	-	O

\*: If equipped

■ Smart key system\*1 (→P.128)

Function	Default setting	Customized setting	A	B	C
Smart key system	On	Off	-	-	O
Smart door unlocking	Driver's door	All the doors	O	-	O
Number of consecutive door lock operations	2 times	As many as desired	-	-	O
Time elapsed before unlocking all the door when gripping and holding the driver's door handle*2	2 seconds	Off			
		1.5 seconds	-	-	O
		2.5 seconds			

\*1: If equipped

\*2: This setting can be changed when the smart door unlocking setting is set

to "Driver's door".

■ **Wireless remote control (→P.104)**

Function	Default setting	Customized setting	A	B	C
Wireless remote control	On	Off	–	–	O
Unlocking operation	Driver's door unlocked in first step, all doors unlocked in second step	All doors unlocked in first step	O	–	O
Theft deterrent panic mode	On	Off	–	–	O
Locking operation when door opened	On	Off	O	–	O
The function that activates the  switch of the wireless remote control when locking the door* (→P.118)	On (Unlocking all the door)	Off	–	–	O
		On (Unlocking back door only)			

\*: If equipped

■ **Power back door<sup>\*1</sup> (→P.118)**

Function	Default setting	Customized setting	A	B	C
Power back door operations	On	Off	–	O	–
Back door opener switch operations	Press and hold	One short press	–	–	O
 switch of the wireless remote control operation	Press and hold	One short press	–	–	O
		Push twice			
		Off			
Operation buzzer volume	3	1	–	O	–
		2			
Operation buzzer while the back door is operating <sup>*2</sup>	Off	On	–	–	O

Function	Default setting	Customized setting	A	B	C
Opening angle	5	1 to 4	-	O	-
		User setting <sup>*3</sup>			
Power back door open operation when the back door opener switch is pressed	On	Off	-	-	O
Back door closing assist	On	Off	-	-	O
Kick Sensor <sup>*1, 4</sup>	On	Off	-	O	O

\*1: If equipped

\*2: The operation buzzer that sounds when the back door begins to operate cannot be turned off.

\*3: The open position is set by the power back door switch. (→P.127)

\*4: When the towing hitch is installed, kick sensor does not work.

■ **Driving position memory<sup>\*</sup> (→P.137)**

Function	Default setting	Customized setting	A	B	C
Selection the door linking driving position memory with door unlock operation	Driver's door	All doors	-	-	O
Function to prevent contact between the head restraint and ceiling (while moving to memory location)	On	Off	-	-	O

\*: If equipped

■ **Power windows, and moon roof<sup>\*</sup> or panoramic moon roof<sup>\*</sup> (→P.156, 159, 162)**

Function	Default setting	Customized setting	A	B	C
Key linked operation (open)	Off	On	-	-	O
Key linked operation (close)	Off	On	-	-	O
Wireless remote control linked operation (open)	Off	On	-	-	O

Function	Default setting	Customized setting	A	B	C
Wireless remote control linked operation signal (buzzer)	On	Off	–	–	O
Side windows open warning function	On	Off	–	–	O
Sliding roof open warning function	On	Off	–	–	O

\*: If equipped

### ■ Lights (→P.209)

Function	Default setting	Customized setting	A	B	C
Daytime Running Lights*	On	Off	O	–	O
Light reminder buzzer	On	Off	–	–	O

\*: Except for Canada

### ■ Automatic light control system\* (→P.209)

Function	Default setting	Customized setting	A	B	C
Light sensor sensitivity	Standard	–2 to 2	O	–	O
Time elapsed before headlights automatically turn off after doors are closed	30 seconds	Off	O	–	O
		60 seconds			
		90 seconds			
Windshield wiper linked headlight illumination	On	Off	–	–	O

\*: If equipped

■ Rear window wiper (→P.218)

Function	Default setting	Customized setting	A	B	C
Back door opening linked rear window wiper stop function	Off	On	-	-	O
Washer linked rear window wiper operation	On	Off	-	-	O
Shift position linked rear window wiper operation (→P.219)	Only once	Off	-	-	O
		Continuous			

■ PCS (Pre-Collision System) (→P.229)

Function	Default setting	Customized setting	A	B	C
PCS (Pre-Collision System)	On	Off	-	O	-
Adjust alert timing	Middle	Early	-	O	-
		Late			

■ LTA (Lane Tracing Assist) (→P.237)

Function	Default setting	Customized setting	A	B	C
Lane centering function	On	Off	-	O	-
Steering assist function	On	Off	-	O	-
Alert sensitivity	High	Standard	-	O	-
Vehicle sway warning function	On	Off	-	O	-
Vehicle sway warning sensitivity	Standard	Low	-	O	-
		High			

■ RSA (Road Sign Assist)\* (→P.247)

Function	Default setting	Customized setting	A	B	C
RSA (Road Sign Assist)	On	Off	-	O	-

Function	Default setting	Customized setting	A	B	C
Excess speed notification method	Display only	No notification	-	O	-
		Display and buzzer			
Excess speed notification level	1 mph (2 km/h)	3 mph (5 km/h)	-	O	-
		5 mph (10 km/h)			
Other notifications method (No-entry notification)	Display only	No notification	-	O	-
		Display and buzzer			

\*: If equipped

#### ■ BSM (Blind Spot Monitor)\* (→P.260)

Function	Default setting	Customized setting	A	B	C
BSM (Blind Spot Monitor)	On	Off	-	O	-
Outside rear view mirror indicator brightness	Bright	Dim	-	O	-
Alert timing for presence of approaching vehicle (sensitivity)	Intermediate	Early	-	O	-
		Late			
		Only when vehicle detected in blind spot			

\*: If equipped

#### ■ RCTA (Rear cross traffic alert) function\*<sup>1</sup> (→P.260)

Function	Default setting	Customized setting	A	B	C
RCTA (Rear cross traffic alert) function	On	Off	-	O	-
Buzzer volume* <sup>2</sup>	Level 2	Level 1	-	O	-
		Level 3			

\*<sup>1</sup>: If equipped



\*2: This setting is linked with the buzzer volume of the intuitive parking assist.

■ Intuitive parking assist\*<sup>1</sup> (→P.270)

Function	Default setting	Customized setting	A	B	C
Intuitive parking assist	On	Off	-	O	O
Buzzer volume* <sup>2</sup>	2	1	-	O	O
		3	-	O	O

\*<sup>1</sup>: If equipped

\*<sup>2</sup>: This setting is linked with the buzzer volume of the RCTA (Rear cross traffic alert) function.

■ PKSB (Parking Support Brake)\* (→P.277)

Function	Default setting	Customized setting	A	B	C
PKSB (Parking Support Brake) function	On	Off	-	O	-

\*: If equipped

■ Stop & Start system\* (→P.345)

Function	Default setting	Customized setting	A	B	C
Change the Stop & Start system duration when the A/C is on	Standard	Extended	-	O	-

\*: If equipped

■ Automatic air conditioning system\* (→P.515)

Function	Default setting	Customized setting	A	B	C
A/C Auto switch operation	On	Off	O	-	O
Switching to the outside air mode when the vehicle is parked	On	Off	-	-	O

\*: If equipped

### ■ Illumination (→P.525)

Function	Default setting	Customized setting	A	B	C
Time elapsed before the interior lights turn off	15 seconds	Off			
		7.5 seconds	O	–	O
		30 seconds			
Operation after the engine switch is turned off	On	Off	–	–	O
Operation when the doors are unlocked	On	Off	–	–	O
Operation when you approach the vehicle with the electronic key on your person <sup>*1</sup>	On	Off	–	–	O
Footwell lighting <sup>*2</sup>	On	Off	–	–	O

\*1: Vehicles with smart key system only

\*2: If equipped

### ■ Vehicle customization

- When the speed linked door locking function and shift position linked door locking function are both on, the door lock operates as follows.
  - If the vehicle is started with all the doors locked, the speed linked door locking function would not operate.
  - If the vehicle is started with any door unlocked, the speed linked door locking function will operate.
- When shifting the shift lever to any position other than P, all the doors will be locked.
- When the smart key system is off, the selecting door to unlock cannot be customized.
- When the doors remain closed after unlocking the doors and the automatic door lock function is activated, the signals will be generated in accordance with the Operation signal (buzzer) and the Operation signal (emergency flashers) settings.

Items to initialize

The following items must be initialized for normal system operation after such cases as the battery being reconnected, or maintenance being performed on the vehicle:

List of the items to initialize

Item	When to initialize	Reference
Intuitive parking assist*1	<ul style="list-style-type: none"> <li>•After reconnecting or changing the battery</li> <li>•After changing a fuse</li> </ul>	P.273
Parking Support Brake*1		P.281
Power back door*1		P.123
Power windows		P.156
Moon roof*1		P.160
Panoramic moon roof*1		P.163
Maintenance required reminder message	<ul style="list-style-type: none"> <li>• After the maintenance is performed</li> </ul>	P.564
Tire pressure warning system*1	<ul style="list-style-type: none"> <li>• When rotating the tires</li> <li>• When changing the tire</li> <li>• After registering the ID codes</li> </ul>	P.590
Toyota parking assist monitor*1	<ul style="list-style-type: none"> <li>• After reconnecting or changing the battery</li> <li>• After changing a fuse</li> </ul>	P.310
Panoramic view monitor*1, 2		P.342

\*1: If equipped

\*2: Vehicles with Audio Plus or Premium Audio, refer to “NAVIGATION AND MULTIMEDIA SYSTEM OWNER’S MANUAL”.



**For owners**

**10**

701

**10-1.For owners**

Reporting safety defects for  
U.S. owners..... 702

Seat belt instructions for  
Canadian owners (in  
French)..... 703

SRS airbag instructions for  
Canadian owners (in  
French)..... 704

**10**

**For owners**

**Reporting safety defects for U.S. owners**

**If you believe that your vehicle has a defect which could cause a crash or could cause injury or death, you should immediately inform the National Highway Traffic Safety Administration (NHTSA) in addition to notifying Toyota Motor Sales, U.S.A., Inc. (Toll-free: 1-800-331-4331).**

**If NHTSA receives similar complaints, it may open an investigation, and if it finds that a safety defect exists in a group of vehicles, it may order a recall and remedy campaign. However, NHTSA cannot become involved in individual problems between you, your dealer, or Toyota Motor Sales, U.S.A., Inc.**

**To contact NHTSA, you may call the Vehicle Safety Hotline toll-free at 1-888-327-4236 (TTY: 1-800-424-9153); go to <http://www.safercar.gov>; or write to: Administrator, NHTSA, 1200 New Jersey Ave., S.E., Washington, DC 20590. You can also obtain other information about motor vehicle safety from <http://www.safercar.gov>.**

### Seat belt instructions for Canadian owners (in French)

**The following is a French explanation of seat belt instructions extracted from the seat belt section in this manual.**

See the seat belt section for more detailed seat belt instructions in English.

### Utilisation adéquate des ceintures de sécurité

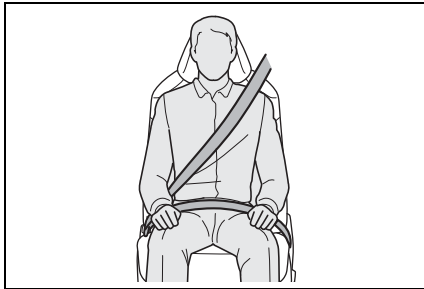

- Tirez sur la ceinture épaulière jusqu'à ce qu'elle recouvre entièrement l'épaule; elle ne doit cependant pas toucher le cou ni glisser de l'épaule.
- Placez la ceinture abdominale le plus bas possible sur les hanches.
- Réglez la position du dossier. Tenez-vous assis bien au fond du siège, le dos droit.
- Ne vrillez pas la ceinture de sécurité.

### Entretien et soin

#### ■ Manipulation des ceintures de sécurité

Avec un chiffon ou une éponge, nettoyez à l'aide d'un savon doux et de l'eau tiède. Vérifiez aussi les ceintures régulièrement pour vous assurer qu'elles ne présentent pas d'usure excessive, d'effilochage ou de coupures.

#### ⚠ AVERTISSEMENT

##### ■ Dommages et usure de la ceinture de sécurité

Vérifiez périodiquement le système de ceintures de sécurité. Vérifiez qu'il n'y a pas de coupures, d'effilochures ni de pièces desserrées. N'utilisez pas une ceinture de sécurité endommagée avant qu'elle ne soit remplacée. Les ceintures de sécurité endommagées ne peuvent pas protéger les occupants contre les blessures graves, voire mortelles.

## SRS airbag instructions for Canadian owners (in French)

The following is a French explanation of SRS airbag instructions extracted from the SRS airbag section in this manual.

See the SRS airbag section for more detailed SRS airbag instructions in English.

### Système de coussins gonflables SRS

#### ■ Emplacement des coussins gonflables SRS

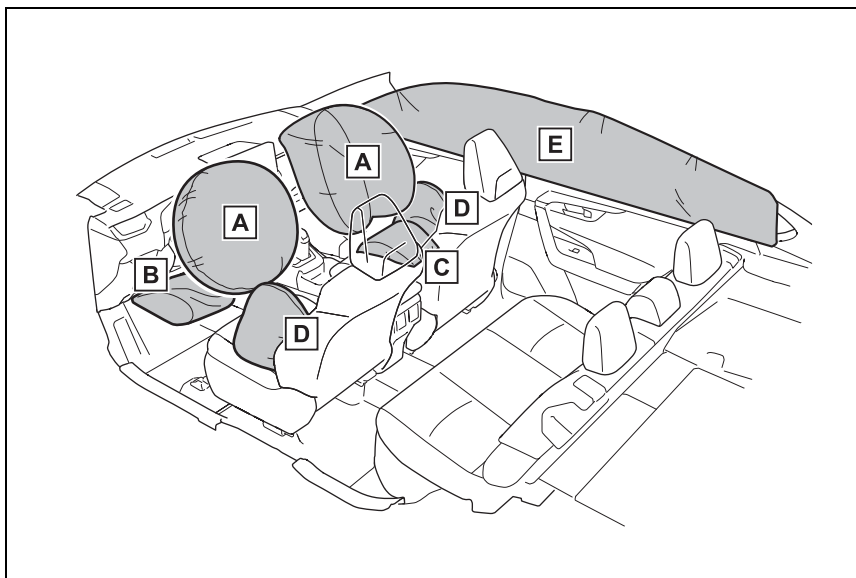

#### ► Coussins gonflables SRS avant

**A** Coussin gonflable SRS du conducteur/coussin gonflable SRS du passager avant

Peuvent aider à protéger la tête et la poitrine du conducteur et du passager avant contre les impacts avec des composants intérieurs

**B** Coussin gonflable SRS de protection des genoux

Peut aider à protéger le conducteur

**C** Coussin gonflable SRS du coussin de siège

Peut aider à retenir le passager avant



► Coussins gonflables SRS latéraux et en rideau

**D** Coussins gonflables SRS latéraux

Peuvent aider à protéger le torse des occupants des sièges avant

**E** Coussins gonflables SRS en rideau

- Peuvent aider à protéger principalement la tête des occupants des sièges latéraux
- Peuvent aider à empêcher les occupants d'être éjectés du véhicule en cas de tonneaux

■ Composants du système de coussins gonflables SRS

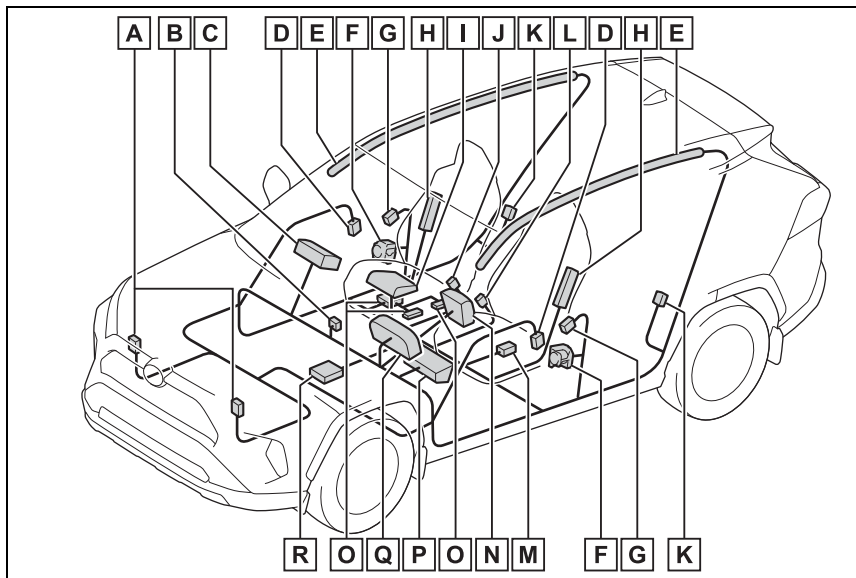

**A** Capteurs d'impact avant

**B** Voyants "AIR BAG ON" et "AIR BAG OFF"

**C** Coussin gonflable du passager avant

**D** Capteurs d'impact latéral (portière avant)

**E** Coussins gonflables en rideau

**F** Limiteurs de force et dispositifs de tension des ceintures de sécurité

**G** Capteurs d'impact latéral (avant)

**H** Coussins gonflables latéraux

**I** Coussin gonflable du coussin de siège

- J** Contacteur de boucle de ceinture de sécurité du passager avant
- K** Capteurs d'impact latéral (arrière)
- L** Contacteur de boucle de ceinture de sécurité du conducteur
- M** Capteur de position du siège du conducteur
- N** Coussin gonflable du conducteur
- O** Système de classification de l'occupant du siège du passager avant (ECU et capteurs)
- P** Coussin gonflable de protection des genoux
- Q** Lampe témoin SRS
- R** Module de capteur de coussin gonflable

Votre véhicule est doté de COUSSINS GONFLABLES ÉVOLUÉS dont la conception s'appuie sur les normes de sécurité des véhicules à moteur américains (FMVSS208). Le module de capteur de coussin gonflable (ECU) contrôle le déploiement des coussins gonflables en fonction des informations obtenues des capteurs et d'autres éléments affichés dans le diagramme des composants du système ci-dessus. Ces informations comprennent des données relatives à la gravité de l'accident et aux occupants. Au moment du déploiement des coussins gonflables, une réaction chimique se produit dans les gonfleurs de coussin gonflable et les coussins gonflables se remplissent rapidement d'un gaz non toxique pour aider à limiter le mouvement des occupants.

**⚠ AVERTISSEMENT****■ Précautions relatives aux coussins gonflables SRS**

Observez les précautions suivantes en ce qui concerne les coussins gonflables SRS.

Négliger de le faire pourrait occasionner des blessures graves, voire mortelles.

- Le conducteur et tous les passagers du véhicule doivent porter leur ceinture de sécurité de la manière appropriée. Les coussins gonflables SRS sont des dispositifs supplémentaires qui doivent être utilisés avec les ceintures de sécurité.

- Le coussin gonflable SRS du conducteur se déploie avec une force considérable et peut occasionner des blessures graves, voire mortelles, notamment lorsque le conducteur se trouve très près du coussin gonflable. La National Highway Traffic Safety Administration (NHTSA), aux États-Unis, fait les recommandations suivantes :

La zone à risque du coussin gonflable du conducteur couvre 2 à 3 in. (50 à 75 mm) de la zone de déploiement du coussin gonflable. Pour assurer une marge de sécurité suffisante, restez à 10 in. (250 mm) du coussin gonflable. Cette distance est mesurée depuis le centre du volant jusqu'à votre sternum. Si maintenant vous vous tenez assis à moins de 10 in. (250 mm), vous pouvez changer votre position de conduite de plusieurs manières :

- Reculez votre siège à la position maximale vous permettant d'atteindre encore aisément les pédales.

- Inclinez légèrement le dossier du siège.

Bien que les véhicules soient conçus différemment, la plupart des conducteurs peuvent maintenir une distance de 10 in.

(250 mm), même si leur siège se trouve complètement vers l'avant, simplement en inclinant un peu le dossier du siège vers l'arrière. Si la visibilité avant est moindre après avoir incliné le dossier de votre siège, utilisez un coussin ferme et non glissant pour être assis plus haut ou relevez le siège si cette option est disponible sur votre véhicule.

- Si votre volant est réglable en hauteur, inclinez-le vers le bas. Cela vous permet d'orienter le coussin gonflable vers votre buste plutôt que vers votre tête et vers votre cou.

Le siège doit être réglé de la manière recommandée ci-dessus par la NHTSA, tout en gardant le contrôle des pédales et du volant, ainsi que la vue sur les commandes du tableau de bord.

**⚠ AVERTISSEMENT**

- Si la rallonge de ceinture de sécurité a été reliée à la boucle des ceintures de sécurité des sièges avant sans avoir aussi été attachée à la plaque de blocage des ceintures de sécurité, les coussins gonflables SRS avant considéreront que le conducteur et le passager avant portent tout de même leur ceinture de sécurité même si les ceintures de sécurité ne sont pas attachées. Les coussins gonflables SRS avant peuvent alors ne pas s'activer correctement lors d'une collision, ce qui pourrait occasionner des blessures graves, voire mortelles, en cas de collision. Assurez-vous de toujours porter la ceinture de sécurité avec la rallonge de ceinture de sécurité.

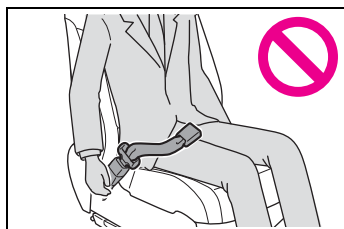

- Le coussin gonflable SRS du passager avant se déploie également avec une force considérable et peut occasionner des blessures graves, voire mortelles, notamment lorsque le passager avant se trouve très près du coussin gonflable. Le siège du passager avant doit se trouver le plus loin possible du coussin gonflable et le dossier doit être réglé de manière à ce que le passager avant soit assis bien droit.

- Le déploiement d'un coussin gonflable risque d'infliger des blessures graves, voire mortelles, aux bébés et aux enfants mal assis et/ou mal attachés. Un bébé ou un enfant trop petit pour utiliser une ceinture de sécurité doit être correctement retenu à l'aide d'un dispositif de retenue pour enfants. Toyota recommande vivement de placer et d'attacher correctement tous les bébés et tous les enfants sur les sièges arrière du véhicule à l'aide de dispositifs de retenue adaptés. Les sièges arrière sont plus sécuritaires pour les bébés et les enfants que le siège du passager avant.
- N'installez jamais un dispositif de retenue pour enfants de type dos à la route sur le siège du passager avant, même si le voyant "AIR BAG OFF" est allumé. En cas d'accident, la force et la vitesse de déploiement du coussin gonflable du passager avant pourraient infliger à l'enfant des blessures graves, voire mortelles, si le dispositif de retenue pour enfants de type dos à la route était installé sur le siège du passager avant.
- Ne vous asseyez pas sur le bord du siège et ne vous appuyez pas sur la planche de bord.

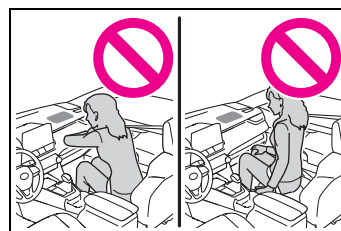

**⚠ AVERTISSEMENT**

- Ne laissez pas un enfant se tenir face au coussin gonflable SRS du passager avant ni s'asseoir sur les genoux d'un passager avant.

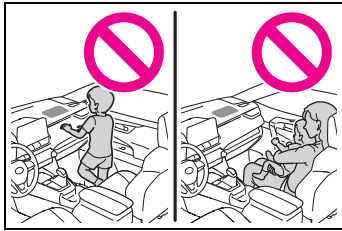

- Ne laissez pas les occupants des sièges avant tenir des objets sur leurs genoux.
- Ne vous appuyez pas sur la portière ou sur le brancard de pavillon, ni sur les montants avant, latéraux ou arrière.



- Ne laissez personne s'agenouiller face à la portière sur le siège du passager ni sortir la tête ou les mains à l'extérieur du véhicule.

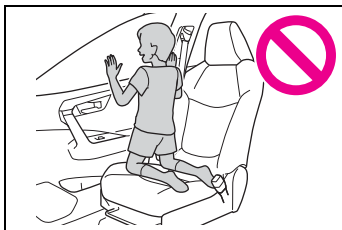

- Ne fixez et n'appuyez rien sur des zones telles que la planche de bord, le tampon de volant ou encore la partie inférieure du tableau de bord. Ces objets peuvent se transformer en projectiles lorsque les coussins gonflables SRS du conducteur, du passager avant et de protection des genoux se déploient.

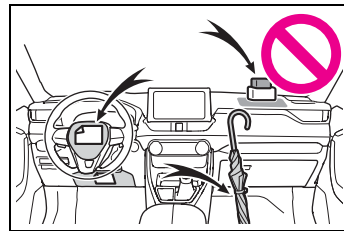

- Ne fixez rien sur des zones telles que les portières, le pare-brise, les glaces latérales, les montants avant ou arrière, le brancard de pavillon et la poignée de maintien.

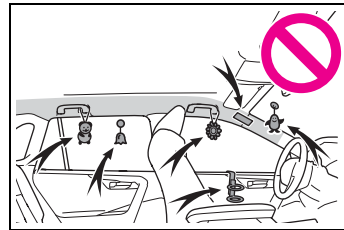

**⚠ AVERTISSEMENT**

- Véhicules non dotés du système Smart key : N'accrochez pas d'objets lourds, pointus ou durs, par exemple des clés ou des accessoires, à la clé. Ces objets pourraient empêcher le déploiement du coussin gonflable SRS de protection des genoux ou être projetés violemment dans l'assise du siège du conducteur par la force du déploiement, et donc présenter un danger.

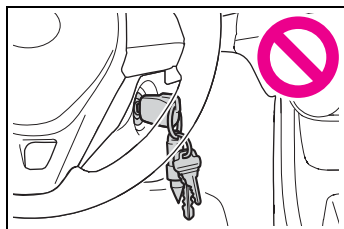

- N'accrochez pas de cintres ni d'autres objets rigides sur les crochets porte-vêtements. Tous ces objets pourraient se transformer en projectiles et vous occasionner des blessures graves, voire mortelles, en cas de déploiement des coussins gonflables SRS en rideau.
- Si un recouvrement de vinyle est placé sur la zone de déploiement du coussin gonflable SRS de protection des genoux, veillez à le retirer.

- N'utilisez pas d'accessoires recouvrant les parties du siège où les coussins gonflables SRS latéraux et le coussin gonflable SRS du coussin de siège se déploient, car ces accessoires pourraient entraver le déploiement des coussins SRS. De tels accessoires peuvent empêcher les coussins gonflables latéraux et le coussin gonflable du coussin de siège de se déployer correctement, rendre le système inopérant ou provoquer accidentellement le déploiement des coussins gonflables latéraux et du coussin gonflable du coussin de siège, occasionnant des blessures graves, voire mortelles.
- Ne frappez pas et n'appliquez pas une pression importante à l'emplacement des portières avant ou des composants des coussins gonflables SRS. Cela peut provoquer un mauvais fonctionnement des coussins gonflables SRS.
- Ne touchez à aucun composant des coussins gonflables SRS immédiatement après leur déploiement (gonflage), car ils pourraient être chauds.
- Si vous avez de la difficulté à respirer après le déploiement des coussins gonflables SRS, ouvrez une portière ou une glace latérale pour laisser entrer l'air frais, ou quittez le véhicule si vous pouvez le faire en toute sécurité. Dès que possible, nettoyez tous les résidus afin d'éviter les irritations cutanées.

### AVERTISSEMENT

- Si les emplacements de stockage des coussins gonflables SRS, tels que le tampon de volant et les garnitures des montants avant et arrière, sont endommagés ou fissurés, faites-les remplacer par votre concessionnaire Toyota.
- Ne placez aucun objet, par exemple un coussin, sur le siège du passager avant. Cela disperserait le poids du passager, ce qui empêcherait le capteur de le détecter correctement. Cela pourrait empêcher le déploiement des coussins gonflables SRS du passager avant en cas de collision.

#### ■ **Modification et mise au rebut des composants du système de coussins gonflables SRS**

Ne mettez pas votre véhicule au rebut et n'effectuez aucune des modifications suivantes sans d'abord consulter votre concessionnaire Toyota. Les coussins gonflables SRS pourraient fonctionner de manière incorrecte ou se déployer (gonfler) accidentellement, ce qui serait susceptible d'occasionner des blessures graves, voire mortelles.

- Installation, retrait, démontage et réparation des coussins gonflables SRS
- Réparations, modifications, retrait ou remplacement du volant, du tableau de bord, de la planche de bord, des sièges ou du capitonnage des sièges, des montants avant, latéraux et arrière, des brancards de pavillon, des panneaux des portières avant, des garnitures des portières avant ou des haut-parleurs des portières avant

- Modifications du panneau de la portière avant (comme le perforer)
- Réparations ou modifications de l'aile avant, du pare-chocs avant ou du côté de l'habitacle
- Installation d'une protection de calandre (barre safari, barre kangourou, etc.), de lames de déneigement, de treuils ou d'un porte-bagages de toit
- Modifications du système de suspension du véhicule
- Installation d'appareils électroniques tels qu'un émetteur-récepteur radio ou un lecteur de CD
- Modifications à votre véhicule pour une personne aux capacités physiques réduites





**Index**

713

---

What to do if... (Trouble-  
shooting) ..... 714  
Alphabetical Index ..... 717

## What to do if... (Troubleshooting)

**If you have a problem, check the following before contacting your Toyota dealer.**

**The doors cannot be locked, unlocked, opened or closed**



### You lose your keys

- If you lose your keys or mechanical keys, new genuine keys or mechanical keys can be made by your Toyota dealer. (→P.653)
- Vehicles with smart key system:  
If you lose your electronic keys, the risk of vehicle theft increases significantly. Contact your Toyota dealer immediately. (→P.653)



### The doors cannot be locked or unlocked

- Is the key battery weak or depleted? (→P.604)
- Vehicles with smart key system:  
Is the engine switch in ON?  
When locking the doors, turn the engine switch off. (→P.197)

- Vehicles with smart key system:  
Is the electronic key left inside the vehicle?  
When locking the doors, make sure that you have the electronic key on your person.
- The function may not operate properly due to the condition of the radio wave. (→P.105, 129)



### The rear door cannot be opened

- Is the child-protector lock set?  
The rear door cannot be opened from inside the vehicle when the lock is set. Open the rear door from outside and then unlock the child-protector lock. (→P.112)

**If you think something is wrong**



### The engine does not start (vehicles without smart key system)

- Is the shift lever in P?  
(→P.193)
- Is the battery discharged?  
(→P.655)



### The engine does not start (vehicles with smart key system)

- Did you press the engine

switch while firmly depressing the brake pedal?  
(→P.194)

- Is the shift lever in P?  
(→P.194)
- Is the electronic key anywhere detectable inside the vehicle? (→P.128)
- Is the steering wheel unlocked? (→P.195)
- Is the electronic key battery weak or depleted?  
In this case, the engine can be started in a temporary way.  
(→P.654)
- Is the battery discharged?  
(→P.655)



**The shift lever cannot be shifted from P even if you depress the brake pedal**

- Is the engine switch in ON?  
If you cannot release the shift lever by depressing the brake pedal with the engine switch in ON (→P.200)



**The steering wheel cannot be turned after the engine is stopped**

- Vehicles without smart key system:  
It is locked to prevent theft of the vehicle if the key is removed from the engine switch. (→P.193)
- Vehicles with smart key sys-

tem:  
It is locked automatically to prevent theft of the vehicle.  
(→P.195)



**The windows do not open or close by operating the power window switches**

- Is the window lock switch pressed?  
The power window except for the one at the driver's seat cannot be operated if the window lock switch is pressed.  
(→P.158)



**The engine switch is turned off automatically (vehicles with smart key system)**

- The auto power off function will be operated if the vehicle is left in ACC or ON (the engine is not running) for a period of time. (→P.198)



**A warning buzzer sounds during driving**

- The seat belt reminder light is flashing

Are the driver and the passengers wearing the seat belts? (→P. 635)

- The parking brake indicator is on

Is the parking brake released?  
(→P.203)

Depending on the situation, other types of warning buzzer

may also sound. (→P.628, 639)



**An alarm is activated and the horn sounds (if equipped)**

- Did anyone inside the vehicle open a door during setting the alarm?  
The sensor detects it and the alarm sounds. (→P.73)

To stop the alarm, turn the engine switch to ON or start the engine.



**A warning buzzer sounds when leaving the vehicle**

- Is the message displayed on the multi-information display?  
Check the message on the multi-information display.  
(→P.639)



**A warning light turns on or a warning message is displayed**

- When a warning light turns on or a warning message is displayed, refer to P.628, 639.

### When a problem has occurred



**If you have a flat tire**

- Stop the vehicle in a safe place and replace the flat tire with the spare tire. (→P.642)



**The vehicle becomes stuck**

- Try the procedure for when the vehicle becomes stuck in mud, dirt, or snow. (→P.661)

## Alphabetical Index

### A

- A/C** ..... **510, 515**
  - Air conditioning filter ..... 599
  - Automatic air conditioning system ..... 515
  - Eco air conditioning mode ... 516
  - Front seat concentrated airflow mode (S-FLOW) ..... 519
  - Manual air conditioning system ..... 510
- ABS (Anti-lock Brake System)** ..... **360**
  - Function ..... 360
  - Warning light ..... 630
- ACA (Active Cornering Assist)** ..... **360**
- Active Cornering Assist (ACA)** ..... **360**
- Airbags** ..... **33**
  - Airbag operating conditions ... 35
  - Airbag precautions for your child ..... 38
  - Airbag warning light ..... 629
  - Correct driving posture ..... 27
  - Curtain shield airbag operating conditions ..... 36
  - Curtain shield airbag precautions ..... 38
  - Front passenger occupant classification system ..... 43
  - General airbag precautions ... 38
  - Locations of airbags ..... 33
  - Modification and disposal of airbags ..... 41
  - Seat cushion airbag ..... 33
  - Side airbag operating conditions ..... 36
  - Side airbag precautions ..... 38
  - Side and curtain shield airbags operating conditions ..... 36
  - Side and curtain shield airbags precautions ..... 38
  - SRS airbag instructions for Canadian owners ..... 704
  - SRS airbags ..... 33
  - SRS warning light ..... 629
- Air conditioning filter** ..... **599**
- Air conditioning system** ..... **510, 515**
  - Air conditioning filter ..... 599
  - Automatic air conditioning system ..... 515
  - Eco air conditioning mode ... 516
  - Front seat concentrated airflow mode (S-FLOW) ..... 519
  - Manual air conditioning system ..... 510
- Alarm** ..... **73**
  - Alarm ..... 73
  - Warning buzzer ..... 628
- AM** ..... **425**
- Anchor brackets** ..... **61**
- Android Auto** ..... **407, 410, 437**
- Android Auto button (Menu screen)** ..... **377**
- Antenna (Smart key system)** ..... **128**
- Anti-lock brake system (ABS)** ..... **360**
  - Function ..... 360
  - Warning light ..... 630
- Apple CarPlay** ..... **434**
- Apple CarPlay®/Android Auto** ..... **407, 410**
- Apple CarPlay button (Menu screen)** ..... **377**
- Approach warning** ..... **256**
- Apps button (Menu screen)** ... **377**
- Armrest** ..... **547**
- Assist grips** ..... **547**
- Audio** ..... **420**
  - Operating information ..... 446
  - Some basics ..... 421
  - Turning the system on and off ..... 421
- Audio button (Menu screen)** .. **377**

- Audio button**  
 (Setup screen) ..... 380, 444  
**AUDIO button**..... 375  
**Audio buttons overview**..... 375  
**Audio settings** ..... 444  
**Automatic air conditioning system**..... 515  
 Air conditioning filter..... 599  
 Eco air conditioning mode.... 516  
**Automatic High Beam**..... 212  
**Automatic light control system**  
 ..... 210  
**Automatic transmission** ..... 199  
 S mode..... 201  
**Auxiliary boxes**..... 530  
**Average fuel consumption** ..... 99  
**Average fuel economy** ..... 91  
**Average vehicle speed**..... 93, 99
- B**
- Back door**..... 114  
 Hands Free Power Back Door  
 ..... 119  
 Power back door ..... 118  
 Wireless remote control ..... 118  
**Back-up lights**  
 Replacing light bulbs ..... 609  
 Wattage ..... 670  
**Battery**  
 Checking ..... 579  
 If the vehicle battery is dis-  
 charged ..... 655  
 Preparing and checking before  
 winter..... 367  
 Replacing ..... 657  
 Warning light ..... 628  
**Blind Spot Monitor (BSM)**..... 260  
 Blind Spot Monitor function .. 264  
 Rear Cross Traffic Alert function  
 ..... 267  
**Bluetooth® button (Setup**  
 screen)..... 380  
**Bluetooth® details settings** ... 394  
 Bluetooth® setup screen..... 395  
 Connecting a Bluetooth® device  
 ..... 395  
 Deleting a Bluetooth® device 397  
 Detailed settings screen ..... 399  
 Displaying the Bluetooth® setup  
 screen..... 394  
 Editing the Bluetooth® device  
 information..... 398  
 Registering a Bluetooth® device  
 ..... 397  
**Bluetooth® device information**  
 ..... 398  
**Bluetooth® hands-free system**  
 ..... 465  
**Bluetooth® phone message func-**  
**tion** ..... 476  
 Calling the message sender 479  
 Checking received messages  
 ..... 477  
 Displaying the message screen  
 ..... 476  
 Receiving a message ..... 477  
 Replying to a message (dicta-  
 tion reply)..... 478  
 Replying to a message (quick  
 reply) ..... 479  
**Bottle holders** ..... 530  
**Brake**  
 Brake Hold..... 206  
 Fluid..... 577  
 Parking brake ..... 203  
 Warning light..... 628  
**Brake assist** ..... 360  
**Brake Hold**..... 206  
**Break-in tips**..... 170  
**Brightness control**  
 Instrument panel light

control ..... 84, 88  
**BSM (Blind Spot Monitor)**..... 260  
 Blind Spot Monitor function ..264  
 Rear Cross Traffic Alert function  
 ..... 267

**C**

**Care**  
 Aluminum wheels ..... 558  
 Exterior ..... 558  
 Interior ..... 561  
 Seat belts ..... 561  
**Cargo capacity** ..... 175, 178  
**Cargo hooks** ..... 532  
**Chains** ..... 369  
**Child-protectors** ..... 112  
**Child restraint system** ..... 50  
 Fixed with a LATCH system ... 59  
 Fixed with a seat belt ..... 54  
 Front passenger occupant clas-  
 sification system ..... 43  
 Points to remember ..... 50  
 Riding with children ..... 49  
 Types of child restraint system  
 installation method ..... 52  
 Using an anchor bracket ..... 61  
**Child safety** ..... 49  
 Airbag precautions ..... 38  
 Back door precautions ..... 114  
 Battery precautions ..... 580, 658  
 Child restraint system ..... 52  
 Heated steering wheel and seat  
 heater precautions ..... 522  
 How your child should wear the  
 seat belt ..... 30  
 Moon roof precautions ..... 160  
 Panoramic moon roof precau-  
 tions ..... 164  
 Power window lock switch.... 158  
 Power window precautions .. 157  
 Rear door child-protectors.... 112  
 Removed key battery precau-

tions ..... 606  
 Seat belt extender precautions  
 ..... 30  
 Seat belt precautions ..... 29  
 Seat heater precautions ..... 522  
**Cleaning** ..... 558, 561  
 Aluminum wheels ..... 558  
 Exterior ..... 558  
 Interior ..... 561  
 Radar sensor ..... 224  
 Seat belts ..... 561  
**Clock** ..... 84, 88  
**Coat hooks** ..... 548  
**Condenser** ..... 577  
**Connected Services** ..... 495  
**Console box** ..... 529  
**Consumption screen** ..... 99  
**Coolant**  
 Checking ..... 576  
 Preparing and checking before  
 winter ..... 367  
 Warning light ..... 629  
**Cooling system** ..... 576  
 Engine overheating ..... 659  
**Cruise control (Dynamic radar  
 cruise control with full-speed  
 range)** ..... 250  
**Cup holders** ..... 529  
**Current fuel consumption** ..... 99  
**Current fuel economy** ..... 91  
**Curtain shield airbags** ..... 33  
**Customizable features** ..... 688

**D**

**Daytime running light system** 209  
 Replacing light bulbs ..... 609  
**DCM** ..... 496, 498, 499, 502  
**Deck board** ..... 532  
**Defogger**  
 Outside rear view  
 mirrors ..... 511, 517  
 Rear window ..... 511, 517

- Windshield..... 511, 517
- Differential ..... 669**
- Digital Rear-view Mirror ..... 145**
- Dimensions ..... 664**
- Dinghy towing ..... 191**
- Display**
  - BSM (Blind Spot Monitor)..... 261
  - Drive information ..... 93
  - Driving information ..... 91
  - Dynamic radar cruise control
    - with full-speed range ..... 250
  - Fuel consumption information 99
  - Intuitive parking assist..... 270
  - LTA (Lane-Tracing Assist) .... 242
  - Multi-information display ..... 89
  - RCTA..... 261
  - Warning messages..... 639
- Do-it-yourself maintenance . 565, 569**
- Door lock**
  - Back door ..... 114
  - Side doors ..... 108
  - Smart key system..... 128
  - Wireless remote control ..... 104
- Doors**
  - Automatic door locking and
    - unlocking system..... 113
  - Back door ..... 114
  - Door glasses ..... 156
  - Door lock ..... 108
  - Open door warning buzzer... 112
  - Outside rear view mirrors .... 154
  - Rear door child-protectors.... 112
  - Side doors ..... 108
- Downhill assist control system ..... 358**
- Drive information ..... 93**
- Driver's seat belt reminder light ..... 635**
- Driver's seat position memory ..... 137**
  - Driving position memory..... 137
  - Memory recall function ..... 138
- Drive-start control ..... 170**
- Driving**
  - Break-in tips ..... 170
  - Correct posture..... 27
  - Driving mode select switch... 351
  - Procedures ..... 169
  - Winter drive tips..... 367
- Driving information display ..... 91**
- Driving mode select switch ... 351**
- Driving position memory ..... 137**
  - Memory recall function ..... 138
- Driving support system information display..... 93**
- Dynamic radar cruise control with full-speed range**
  - Function..... 250
  - Warning message..... 639
- Dynamic Torque Control AWD system ..... 361**
- Dynamic Torque Vectoring AWD system ..... 361**

**E**

- Eco drive mode..... 351**
- Eco Driving Indicator ..... 92**
- Eco Driving Indicator Light..... 92**
- EDR (Event data recorder)..... 10**
- Elapsed time ..... 93**
- Electric Power Steering (EPS)**
  - Function..... 360
  - Warning light..... 630
- Electronic key**
  - Battery-saving function ..... 129
  - If the electronic key does not
    - operate properly ..... 653
  - Replacing the battery ..... 604
- Electronic sunshade ..... 162**
  - Jam protection function ..... 163
  - Operation..... 162
- Emergency, in case of**
  - If a warning buzzer sounds .. 628



If a warning light turns on ..... 628  
 If a warning message is displayed..... 639  
 If the electronic key does not operate properly ..... 653  
 If the engine will not start ..... 651  
 If the vehicle battery is discharged ..... 655  
 If the vehicle is trapped in rising water ..... 619  
 If you have a flat tire ..... 642  
 If you lose your keys ..... 653  
 If you think something is wrong ..... 626  
 If your vehicle becomes stuck ..... 661  
 If your vehicle has to be stopped in an emergency..... 618  
 If your vehicle needs to be towed ..... 621  
 If your vehicle overheats ..... 659  
**Emergency flashers ..... 618**  
**Engine**  
 ACC..... 193, 197  
 Compartment ..... 574  
 Engine switch ..... 193, 194  
 Fuel pump shut off system ... 627  
 Hood..... 571  
 How to start the engine 193, 194  
 Identification number..... 665  
 If the engine will not start ..... 651  
 If your vehicle has to be stopped in an emergency..... 618  
 Ignition switch (Engine switch) ..... 193, 194  
 Overheating..... 659  
 Tachometer ..... 82, 85  
**Engine coolant**  
 Capacity ..... 668  
 Checking ..... 576  
 Preparing and checking before winter..... 367

Warning light..... 629  
**Engine coolant temperature gauge ..... 82, 85**  
**Engine immobilizer system ..... 70**  
**Engine oil**  
 Capacity ..... 666  
 Checking ..... 574  
 Preparing and checking before winter ..... 367  
 Warning light..... 629  
**Engine switch ..... 193, 194**  
 Auto power off function..... 198  
 Changing the engine switch modes..... 197  
 Changing the engine switch positions ..... 193  
 If your vehicle has to be stopped in an emergency..... 618  
**Enhanced Vehicle Stability Control (Enhanced VSC)..... 360**  
**Enhanced VSC (Enhanced Vehicle Stability Control)..... 360**  
**Entering letters and numbers/list screen operation..... 385**  
 Entering letters and numbers..... 385  
 List screen ..... 386  
**EPS (Electric Power Steering)**  
 Function..... 360  
 Warning light..... 630  
**Establishing an Android Auto connection ..... 408**  
**Establishing an Apple CarPlay connection ..... 407**  
**Event data recorder (EDR)..... 10**

**F**

**Flat tire..... 642**  
 Tire pressure warning system ..... 584  
**Floor mats ..... 26**  
**Fluid**  
 Automatic transmission ..... 669

Brake ..... 577, 670  
 Washer ..... 580  
**FM** ..... 425  
**Fog lights**  
   Replacing light bulbs ..... 609  
   Switch ..... 215  
   Wattage ..... 670  
**Footwell lights** ..... 525  
**Front passenger's seat belt  
 reminder light** ..... 635  
**Front passenger occupant clas-  
 sification system** ..... 43  
**Front seat heaters** ..... 522  
**Front seats** ..... 134  
   Adjustment ..... 134  
   Cleaning ..... 561  
   Correct driving posture ..... 27  
   Driving position memory ..... 137  
   Head restraints ..... 140  
   Memory recall function ..... 138  
   Seat heaters ..... 522  
   Seat position memory ..... 137  
   Seat ventilators ..... 522  
**Front side marker lights** ..... 209  
   Light switch ..... 209  
   Replacing light bulbs ..... 609  
   Wattage ..... 670  
**Front turn signal lights**  
   Replacing light bulbs ..... 609  
   Turn signal lever ..... 202  
   Wattage ..... 670  
**Fuel**  
   Capacity ..... 666  
   Fuel gauge ..... 82, 85  
   Fuel pump shut off system ... 627  
   Gas station information ..... 736  
   Information ..... 676  
   Refueling ..... 220  
   Type ..... 666, 676  
   Warning light ..... 634  
**Fuel consumption information 99**  
   Average fuel economy ..... 91

Current fuel consumption ..... 99  
**Fuel filler door** ..... 221  
   Refueling ..... 220  
**Fuel gauge** ..... 82, 85  
**Fuel pump shut off system** ..... 627  
**Fuses** ..... 607

## G

**Garage door opener** ..... 548  
**Gas station information** ..... 736  
**Gauges** ..... 82, 85  
**General button (Setup screen)**  
   ..... 380, 414  
**General settings** ..... 414  
   Displaying the general settings  
   screen ..... 414  
   General settings screen ..... 414  
**Glove box** ..... 528

## H

**Hands-free system** ..... 465  
**Headlights** ..... 209  
   Automatic High Beam system  
   ..... 212  
   Light switch ..... 209  
   Replacing light bulbs ..... 609  
   Wattage ..... 670  
**Head restraints** ..... 140  
**Heated steering wheel** ..... 522  
**Heaters**  
   Automatic air conditioning sys-  
   tem ..... 515  
   Heated steering wheel ..... 522  
   Manual air conditioning system  
   ..... 510  
   Outside rear view  
   mirrors ..... 511, 517  
   Seat heaters ..... 522  
**High mounted stoplight**  
   Replacing light bulbs ..... 609  
**Hill-start assist control** ..... 360

**HOME button** .....384  
**Home screen**.....384  
**Hood** .....571  
**Hooks**  
 Cargo hooks.....532  
 Coat hooks .....548  
 Retaining hooks (floor mat)....26  
**Horn**.....142

**I**

**I/M test**.....568  
**Identification**  
 Engine .....665  
 Vehicle.....665  
**Ignition switch (Engine switch)**  
 .....193, 194  
 Auto power off function .....198  
 Changing the engine switch  
 modes .....197  
 Changing the engine switch  
 positions .....193  
 If your vehicle has to be stopped  
 in an emergency.....618  
 Starting the engine .....193, 194  
**Immobilizer system**.....70  
**Indicators** .....76  
**Info button (Menu screen)**.....377  
**Initialization**  
 Items to initialize.....699  
 Maintenance.....565  
 Moon roof .....160  
 Panoramic moon roof.....163  
 Parking Support Brake .....281  
 Power back door .....123  
 Power windows .....156  
 Tire pressure warning system  
 .....590  
**Initial screen** .....381  
 Caution screen .....381  
 Restarting the system .....381  
**Inside rear view mirror**...143, 145  
**Instrument panel light**

**control** .....84, 88  
**Interior lights**.....525  
 Switch.....525  
 Wattage .....670  
**Intuitive parking assist**  
 Function.....270  
 Warning message.....273  
**iPod/iPhone (Apple CarPlay)** .434

**J**

**Jack**  
 Positioning a floor jack .....572  
 Vehicle-equipped jack .....643  
**Jack handle** .....643  
**Jam protection function**  
 Electronic sunshade .....163  
 Moon roof .....159  
 Panoramic moon roof .....163  
 Power back door .....121  
 Power windows .....156

**K**

**Keyless entry**  
 Smart key system .....128  
 Wireless remote control.....104  
**Keys** .....102  
 Battery-saving function .....129  
 Electronic key .....102  
 Engine switch .....193, 194  
 If the electronic key does not  
 operate properly .....653  
 If you lose your keys.....653  
 Key number plate .....102  
 Keyless entry .....104, 128  
 Mechanical key.....107  
 Replacing the battery .....604  
 Warning buzzer .....128  
 Wireless remote control key .104  
**Knee airbags** .....33

**L**

- Lane Tracing Assist (LTA)..... 237**
  - Operation ..... 237
  - Warning messages..... 246
- Language (multi-information display)..... 96, 689**
- LATCH anchors ..... 59**
- Lever**
  - Auxiliary catch lever ..... 571
  - Hood lock release lever..... 571
  - Shift lever ..... 199
  - Turn signal lever..... 202
  - Wiper lever ..... 215, 218
- License plate lights**
  - Light switch ..... 209
  - Replacing light bulbs ..... 609
- Light bulbs**
  - Replacing ..... 609
  - Wattage ..... 670
- Lights**
  - Automatic High Beam system ..... 212
  - Fog light switch ..... 215
  - Front interior lights ..... 525
  - Headlight switch ..... 209
  - Interior lights..... 525
  - Personal lights..... 526
  - Rear interior light..... 526
  - Replacing light bulbs ..... 609
  - Turn signal lever..... 202
  - Vanity lights ..... 537
  - Wattage ..... 670
- Linking multi-information display and the system ..... 389**
- Lock steering column ..... 195**
- LTA (Lane Tracing Assist)..... 237**
  - Operation ..... 237
  - Warning messages..... 246
- Luggage compartment light..... 117, 120**
  - Wattage ..... 670

- Luggage cover ..... 534**

**M**

- Maintenance**
  - Do-it-yourself maintenance .. 569
  - General maintenance ..... 565
  - Maintenance data ..... 664
  - Maintenance requirements... 564
- Malfunction indicator lamp.... 629**
- Manual air conditioning system ..... 510**
  - Air conditioning filter ..... 599
- Menu icons..... 90**
- Menu screen..... 377**
  - Menu screen operation..... 377
- Meter**
  - Clock ..... 82, 85
  - Indicators ..... 76
  - Instrument panel light control..... 84, 88
  - Meter control switches..... 90
  - Meters ..... 82, 85
  - Multi-information display..... 89
  - Settings ..... 94, 689
  - Units ..... 96, 689
  - Warning lights..... 628
  - Warning messages..... 98, 639
- Meter control switches..... 90**
- Microphone ..... 468**
- Mirrors**
  - Digital Rear-view Mirror ..... 145
  - Inside rear view mirror ..... 143
  - Outside rear view mirror defoggers ..... 511, 517
  - Outside rear view mirrors ..... 154
  - Vanity mirrors..... 537
- Moon roof**
  - Door lock linked moon roof operation..... 159
  - Jam protection function ..... 159
  - Operation..... 159
  - Warning message..... 160

**Mud & Sand mode** ..... 353

**Multi-information display**

- Audio system-linked display ... 93
- Changing the display ..... 90
- Display contents ..... 89
- Driving information display ..... 91
- Driving support system information display ..... 93
- Dynamic radar cruise control
  - with full-speed range ..... 250
- Eco Driving Indicator ..... 92
- Intuitive parking assist-sensor
  - ..... 270
- Language ..... 96, 689
- LTA (Lane-Tracing Assist) .... 242
- Menu icons ..... 90
- Meter control switches ..... 90
- Navigation system-linked display
  - ..... 93
- PCS (Pre-Collision System) . 229
- Pop-up display ..... 96
- Settings ..... 94, 689
- Suggestion function ..... 98
- Tire pressure ..... 584
- Units ..... 96, 689
- Vehicle information display ..... 93
- Warning message display ..... 98
- Warning messages ..... 639

**Multi-terrain Select** ..... 353

**N**

**Navigation system-linked display** ..... 93

**Noise from under vehicle** ..... 8

**Normal mode** ..... 351, 354

**O**

**Odometer** ..... 82, 85

**Odometer and trip meter display**

- “ODO TRIP” switch ..... 84, 88
- “ODO TRIP” switch ..... 84, 88

**Oil**

- Engine oil ..... 666
- Rear differential oil ..... 669
- Transfer oil ..... 669

**Opener**

- Back door ..... 116, 118
- Fuel filler door ..... 221
- Hood ..... 571

**Outer foot lights**

- Replacing light bulbs ..... 609
- Wattage ..... 670

**Outside rear view mirrors** ..... 154

- Adjusting and folding ..... 154
- BSM (Blind Spot Monitor) ..... 261
- Outside rear view mirror defoggers ..... 511, 517

**Outside temperature display** ..... 83, 87

**Overheating** ..... 659

**P**

**Panic mode** ..... 105

**Panoramic moon roof**

- Jam protection function ..... 163
- Operation ..... 162
- Warning message ..... 164

**Panoramic view monitor** ..... 313

- Camera switch ..... 315
- Checking around the vehicle 318
- Checking the front and around the vehicle ..... 319
- Checking the rear and around the vehicle ..... 324
- Checking the sides of the vehicle ..... 321
- Customizing the panoramic view monitor ..... 332
- Display ..... 315
- Driving precautions ..... 313
- How to switch the display ..... 316
- Magnifying function ..... 332
- Panoramic view monitor precau-

- tions.....333
- Things you should know.....342
- When folding the outside rear view mirrors.....331
- Parking assist sensors (intuitive parking assist).....270**
- Parking brake**
  - Operation .....203
  - Parking brake engaged warning buzzer .....205
  - Warning light .....634
  - Warning message .....205
- Parking lights**
  - Light switch .....209
  - Replacing light bulbs .....609
  - Wattage .....670
- Parking Support Brake (PKSB).....277**
  - Indicator .....79
  - Parking Support Brake function (rear-crossing vehicles).....288
  - Parking Support Brake function (static objects) .....282
  - Warning light.....632
  - Warning message.....281
- PKSB (Parking Support Brake).....277**
  - Indicator.....79
  - Parking Support Brake function (rear-crossing vehicles) .....288
  - Parking Support Brake function (static objects) .....282
  - Warning light.....632
  - Warning message.....281
- Placing a call using the Bluetooth® hands-free system....470**
  - By call history .....470
  - By contacts list .....471
  - By favorites list .....471
  - By home screen .....473
  - By keypad.....472
- Power back door switch 118, 119**
- Power outlets .....537**
- Power steering (Electric Power Steering system).....360**
  - Warning light.....630
- POWER VOLUME knob .....421**
- Power windows**
  - Door lock linked window operation.....157
  - Jam protection function .....156
  - Operation.....156
  - Window lock switch .....158
- Pre-Collision System (PCS)**
  - Enabling/disabling the pre-collision system .....231
- Voice command system .....469
- When selling or disposing of the vehicle .....469
- Phone button (Menu screen) .377**
- Phone button (Setup screen) 380**
- Phone button .....465**
- Phone settings.....481**
  - Contacts/Call history settings483
  - Message settings .....489
  - Notifications/display settings 482
  - Sounds settings .....481

Function .....229  
 Warning light .....630  
 Warning message .....227, 641  
**Projection button (Menu screen)**  
 .....377

**R**

**Radar cruise control**  
 Dynamic radar cruise control  
 with full-speed range .....250  
**Radiator**.....577  
**Radio** .....425  
**Ranking lights**  
 Light switch .....209  
**RCTA (Rear Cross Traffic Alert)**  
 RCTA Function .....260, 267  
 Warning message .....262  
**Rear Cross Traffic Alert (RCTA)**  
 .....260  
**Rear passengers' seat belt  
 reminder light** .....635  
**Rear seat**  
 Folding down the rear seatbacks  
 .....136  
 Head restraints .....140  
 Seat heaters .....522  
**Rear seat heaters** .....522  
**Rear side marker lights**  
 Light switch .....209  
 Replacing light bulbs .....609  
**Rear turn signal lights**  
 Replacing light bulbs .....609  
 Turn signal lever .....202  
 Wattage .....670  
**Rear view mirror**  
 Digital Rear-view Mirror .....145  
 Inside rear view mirror .....143  
 Outside rear view mirrors .....154  
**Rear view monitor system**.....292  
 Driving precautions .....292  
 Rear view monitor system pre-  
 cautions .....294  
 Screen description .....293  
 Things you should know .....298  
**Rear window defogger**...511, 517  
**Rear window wiper**.....218  
**Receiving a call using the Blue-  
 tooth® hands-free system**....473  
**Refueling** .....220  
 Capacity .....666  
 Fuel types .....666, 676  
 Opening the fuel tank cap ....221  
**Registering/Connecting a Blue-  
 tooth® device** .....390  
 Profiles .....393  
 Registering a Bluetooth® audio  
 player for the first time .....392  
 Registering a Bluetooth® phone  
 for the first time .....390  
**Remote Connect**.....502  
**Replacing**  
 Electronic key battery .....604  
 Fuses .....607  
 Light bulbs .....609  
 Tires .....642  
 Wiper insert .....601  
 Wireless remote control battery  
 .....604  
**Reporting safety defects for U.S.  
 owners** .....702  
**Resetting the message indicat-  
 ing maintenance is required**565  
**Road Sign Assist** .....247  
**Rock & Dirt mode** .....353  
**RSA (Road Sign Assist)** .....247

**S**

**Screen adjustment** .....388  
**Seat belt reminder light**.....635  
**Seat belts**.....29  
 Adjusting the seat belt shoulder  
 anchor height .....31  
 Automatic Locking Retractor ..31

- Child restraint system installation ..... 54
- Cleaning and maintaining the seat belt..... 561
- Emergency Locking Retractor 31
- How to wear your seat belt..... 30
- How your child should wear the seat belt..... 30
- Pregnant women, proper seat belt use..... 29
- Reminder light and buzzer ..... 635
- Seat belt extender ..... 30
- Seat belt instructions for Canadian owners ..... 703
- Seat belt pretensioners ..... 32
- SRS warning light..... 629
- Seat heaters ..... 522**
- Seating capacity ..... 178**
- Seat position memory ..... 137**
- Seats**
  - Adjustment precautions 134, 135
  - Adjustment ..... 134, 135
  - Child restraint system installation ..... 50
  - Cleaning ..... 561
  - Driving position memory..... 137
  - Folding down the rear seatbacks ..... 136
  - Head restraint..... 140
  - Properly sitting in the seat..... 27
  - Seat heaters ..... 522
  - Seat position memory ..... 137
  - Seat ventilators ..... 522
- Seat ventilators ..... 522**
- Secondary Collision Brake.... 361**
- Sensor**
  - Automatic headlight system . 210
  - Automatic High Beam system ..... 212
  - BSM (Blind Spot Monitor)..... 263
  - Digital Rear-view Mirror..... 148
  - Inside rear view mirror ..... 144
  - Intuitive parking assist ..... 270
  - LTA (Lane Tracing Assist) ..... 237
  - Parking Support Brake function (rear-crossing vehicles) ..... 263
  - Parking Support Brake function (static objects) ..... 270
  - Rain-sensing windshield wipers ..... 217
  - RCTA ..... 263
  - Toyota Safety Sense 2.0 ..... 223
- Service Connect ..... 503**
- Service reminder message .... 565**
- Setup button (Menu screen) ..... 377, 380**
- Setup screen ..... 380**
- Shift lever ..... 199**
  - Automatic transmission ..... 199
  - If the shift lever cannot be shifted from P ..... 200
- Shift lock system ..... 200**
- Side airbags ..... 33**
- Side auxiliary box ..... 534**
- Side doors ..... 108**
- Side marker lights**
  - Light switch ..... 209
  - Replacing light bulbs ..... 609
  - Wattage ..... 670
- Side mirrors ..... 154**
  - Adjustment ..... 154
  - BSM (Blind Spot Monitor) ..... 261
  - Folding..... 154
  - Heaters ..... 511, 517
- Side turn signal lights**
  - Replacing light bulbs ..... 609
  - Turn signal lever ..... 202
- Side windows ..... 156**
- Smart key system ..... 128**
  - Antenna location..... 128
  - Entry functions..... 108, 115
  - Starting the engine ..... 194
  - Warning message..... 639



- Snow mode switch** ..... 357
- Snow tires** ..... 367
- Spare tire**
  - Storage location ..... 643
- Spark plug**..... 668
- Specifications** ..... 664
- Speedometer** ..... 82, 85
- Sport mode** ..... 351
- Status icon**..... 378
  - Status icon explanation ..... 378
- Steering lock**
  - Column lock release..... 193, 195
  - Steering lock system warning message..... 195
- Steering switch**..... 442, 458
  - Audio switch ..... 442
- Steering wheel**
  - Adjustment ..... 142
  - Heated steering wheel ..... 522
  - Meter control switches ..... 90
- Stop lights**
  - Replacing light bulbs ..... 609
- Stop & Start system**
  - Function ..... 345
  - Replacing the battery ..... 657
- Storage feature** ..... 528
- Storage precautions** ..... 528
- Stuck**
  - If the vehicle becomes stuck 661
- Suggestion function**..... 98
- Sunglass holder** ..... 530
- Sunshade** ..... 159, 162
- Sun visors** ..... 537
- Switches**
  - “ODO TRIP”switch ..... 84, 88
  - “SOS” button ..... 65
  - Automatic High Beam switch 212
  - Brake hold switch ..... 206
  - BSM (Blind Spot Monitor)..... 262
  - Digital Rear-view Mirror control switches ..... 145
  - Door lock switch ..... 112
  - Driving mode select switch... 351
  - Driving position memory switches..... 137
  - Dynamic radar cruise control with full-speed range ..... 250
  - Electronic sunshade switch .. 162
  - Emergency flashers switch... 618
  - Engine switch ..... 193, 194
  - Fog light switch..... 215
  - Garage door opener switches ..... 548
  - Heated steering wheel..... 522
  - Ignition switch (Engine switch) ..... 193, 194
  - Intuitive parking assist ..... 271
  - Light switch..... 209
  - LTA switch..... 242
  - Meter control switches..... 90
  - Moon roof switches ..... 159
  - Outside rear view mirror switches..... 154
  - Panoramic moon roof switches ..... 162
  - Parking brake switch ..... 203
  - PCS (Pre-Collision System) .231
  - PKSB (Parking Support Brake) ..... 278
  - Power back door switch 118, 119
  - Power door lock switch..... 112
  - Power window switch ..... 156
  - RCTA ..... 262
  - Rear window and outside rear view mirror defoggers switch ..... 511, 517
  - Rear window wiper and washer switch ..... 218
  - Seat heater switches .... 522, 523
  - Seat ventilator switches..... 523
  - Snow mode switch ..... 357
  - Tire pressure warning reset switch ..... 590
  - Vehicle-to-vehicle distance

switch .....	250
VSC OFF switch.....	361
Window lock switch.....	158
Windshield defogger	
switch .....	511, 517
Windshield wipers and washer	
switch .....	215

**T**

<b>Tachometer .....</b>	<b>82, 85</b>
-------------------------	---------------

**Tail lights**

Light switch .....	209
Replacing light bulbs .....	609

**Talking on the Bluetooth® hands-free system .....**

Call screen operation .....	474
Incoming call waiting .....	476
Sending tones .....	475
Transmit volume setting .....	475

**Theft deterrent system**

Alarm .....	73
Engine immobilizer system .....	70

**Tire inflation pressure**

Maintenance data.....	670
Tire inflation pressure display	
function.....	584
Warning light .....	634

**Tire information .....**

Glossary .....	682
Size .....	680
Tire identification number .....	679
Tire section names .....	680

**Tire pressure warning system**

Function .....	584
Initializing .....	590
Installing tire pressure warning	
valves and transmitters .....	589
Registering ID codes .....	593
Warning light .....	634

**Tires.....**

Chains .....	369
--------------	-----

Checking .....	581
----------------	-----

Glossary .....	682
----------------	-----

If you have a flat tire .....	642
-------------------------------	-----

Inflation pressure .....	595
--------------------------	-----

Information .....	678
-------------------	-----

Replacing .....	642
-----------------	-----

Rotating tires .....	583
----------------------	-----

Size .....	670
------------	-----

Snow tires.....	367
-----------------	-----

Spare tire.....	642
-----------------	-----

Tire identification number .....	679
----------------------------------	-----

Tire inflation pressure display	
function.....	584

Tire pressure warning system	
.....	584

Uniform Tire Quality Grading	
.....	681

Warning light.....	634
--------------------	-----

**Tools .....**

.....	643
-------	-----

**Top tether strap .....**

.....	61
-------	----

**Total load capacity .....**

.....	175, 178
-------	----------

**Touch screen .....**

Touch screen gestures .....	382
-----------------------------	-----

Touch screen operation .....	383
------------------------------	-----

**Towing**

Dinghy towing .....	191
---------------------	-----

Emergency towing.....	623
-----------------------	-----

Towing eyelet.....	624, 643
--------------------	----------

Trailer sway control .....	360
----------------------------	-----

Trailer towing .....	179
----------------------	-----

**Toyota Apps .....**

Entering keyword.....	506
-----------------------	-----

**Toyota Apps button (Setup**

screen).....	380
--------------	-----

**Toyota Apps settings .....**

.....	508
-------	-----

**Toyota parking assist monitor**

.....	300
-------	-----

Distance guide line display mode	
.....	305

Driving precautions.....	300
--------------------------	-----

Estimated course line display	
mode .....	303

Parking assist guide line display	
-----------------------------------	--

mode ..... 304  
 Screen display ..... 301  
 Things you should know ..... 310  
 Toyota parking assist monitor  
 precautions ..... 306  
 Using the system ..... 302  
**Toyota Safety Sense 2.0 ..... 223**  
 Automatic High Beam ..... 212  
 Dynamic radar cruise control  
 with full-speed range ..... 250  
 LTA (Lane Tracing Assist) ..... 237  
 PCS (Pre-Collision System) ..... 229  
 RSA (Road Sign Assist) ..... 247  
**TRAC (Traction Control) ..... 360**  
**Traction Control (TRAC) ..... 360**  
**Trailer sway control ..... 360**  
**Trailer towing ..... 179**  
**Transmission**  
 Automatic transmission ..... 199  
 Driving mode select switch ..... 351  
 S mode ..... 201  
**Trip meters ..... 82, 85**  
**Troubleshooting**  
 In other situations ..... 494  
 When making/receiving a call  
 ..... 492  
 When registering/connecting a  
 cellular phone ..... 491  
 When using the Bluetooth® mes-  
 sage function ..... 493  
 When using the hands-free sys-  
 tem with a Bluetooth® device  
 ..... 491  
 When using the phonebook ..... 492  
**Turn signal lights**  
 Replacing light bulbs ..... 609  
 Turn signal lever ..... 202  
 Wattage ..... 670

**U**

**USB charging ports ..... 539**

**USB memory ..... 432**  
**USB port ..... 422**  
**Utility vehicle precautions ..... 370**

**V**

**Vanity lights**  
 Vanity lights ..... 537  
 Wattage ..... 670  
**Vanity mirrors ..... 537**  
**Vehicle button (Setup screen) 380**  
**Vehicle data recordings ..... 9**  
**Vehicle identification number 665**  
**Vehicle Stability Control (VSC)**  
 ..... 360  
**Ventilators (seat ventilators) .522**  
**Voice button (Setup screen) .380**  
**Voice command system ..... 458**  
 Voice command system opera-  
 tion ..... 459  
**VSC (Vehicle Stability Control)**  
 ..... 360

**W**

**Warning buzzers**  
 Approach warning ..... 256  
 Brake hold ..... 633  
 Brake Override System ..... 633  
 Brake system ..... 628  
 Downshifting ..... 202  
 Drive-Start Control ..... 633  
 Electric power steering ..... 630  
 High coolant temperature ..... 629  
 Intuitive parking assist OFF indi-  
 cator ..... 631  
 Intuitive parking assist ..... 270  
 Low engine oil pressure ..... 629  
 LTA (Lane Tracing Assist) ..... 237  
 LTA indicator ..... 631  
 Open door ..... 112  
 Open hood ..... 112  
 Open window ..... 157

- PKSB OFF indicator ..... 632
- Pre-collision warning ..... 229
- RCTA (Rear Cross Traffic Alert)
  - ..... 261
- RCTA OFF indicator ..... 632
- Seat belt reminder ..... 635
- Vehicle sway warning ..... 241
- Warning lights**
- ABS ..... 630
- Brake hold operated indicator
  - ..... 633
- Brake Override System ..... 633
- Brake system ..... 628
- Charging system ..... 628
- Drive-Start Control ..... 633
- Electric power steering ..... 630
- Engine ..... 629
- High coolant temperature ..... 629
- Intuitive parking assist OFF indicator
  - ..... 631
- Low engine oil pressure ..... 629
- Low fuel level ..... 634
- LTA indicator ..... 631
- Malfunction indicator lamp ... 629
- Parking brake indicator ..... 634
- PCS warning light ..... 630
- PKSB (Parking Support Brake)
  - ..... 633
- PKSB OFF indicator ..... 632
- RCTA OFF indicator ..... 632
- Seat belt reminder light 635, 635
- Slip indicator ..... 632
- SRS ..... 629
- Stop & Start cancel indicator 631
- Tire pressure ..... 634
- Warning messages ..... 639**
- Washer**
- Checking ..... 580
- Low washer fluid warning message
  - ..... 580, 639
- Preparing and checking before winter ..... 367
- Switch ..... 215, 218
- Washing and waxing ..... 558**
- Weight**
- Cargo capacity ..... 175, 178
- Load limits ..... 178
- Weight ..... 664
- Wheels ..... 597**
- Replacing wheels ..... 597
- Size ..... 670
- Wi-Fi® ..... 402**
- Connecting a device to the in-vehicle access point ..... 402
- Operating hints ..... 405
- Wi-Fi® button (Setup screen) 380**
- Wi-Fi® Hotspot ..... 402**
- Window glasses**
- Power windows ..... 156
- Window lock switch ..... 158**
- Windows**
- Power windows ..... 156
- Rear window defogger . 511, 517
- Washer ..... 215, 218
- Windshield defogger ..... 511, 517**
- Windshield wipers**
- Intermittent windshield wipers
  - ..... 215
- Position ..... 215, 218
- Rain-sensing windshield wipers
  - ..... 215
- Replacing the wiper insert ... 601
- Winter driving tips ..... 367**
- Wiper insert ..... 601**
- Wireless charger ..... 540**
- Wireless remote control ..... 104**
- Battery-saving function ..... 129
- Locking/Unlocking ..... 104
- Panic mode ..... 105
- Replacing the battery ..... 604

---

---

For vehicles with Premium Audio with Navigation or Audio Plus, refer to "NAVIGATION AND MULTIMEDIA SYSTEM OWNER'S MANUAL" for information regarding the equipment listed below.

- Navigation system
- Audio system
- Rear view monitor system
- Toyota parking assist monitor
- Panoramic view monitor







## GAS STATION INFORMATION

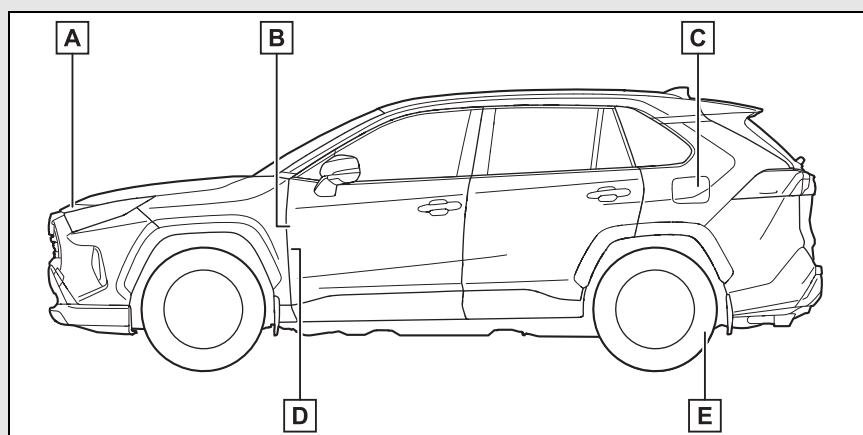

- A** Auxiliary catch lever (→P.571)
- B** Fuel filler door opener lever (→P.221)
- C** Fuel filler door (→P.221)
- D** Hood lock release lever (→P.571)
- E** Tire inflation pressure (→P.671)

Fuel tank capacity (Reference)	14.5 gal. (55 L, 12.1 Imp.gal.)	
Fuel type	Unleaded gasoline only	P.666
Cold tire inflation pressure		P.671
Engine oil capacity (Drain and refill — reference)		P.666
Engine oil type		P.666