

2020 WRANGLER

Jeep®



DEP
DEALER ePROCESS

2020 JEEP® WRANGLER

YOUR SPIRIT OF DISCOVERY FULFILLED

When you're powered by this kind of authentic Jeep® Brand capability, you're given the confidence to travel wherever your dreams want to go. Jeep Wrangler is purpose-built to tackle the elements and win every time. Wrangler is recognized the world over as a true icon — it's as one-of-a-kind as the destinations you're outfitted to discover and explore. Answer the call of open-air freedom and give your spirit permission to explore every corner of the world with confidence.



Rubicon® Unlimited in Bright White

DEP
DEALER PROCESS

INTERIOR

- Heated steering wheel and front seats*
- Leather-trimmed seats*
- Leather-wrapped steering wheel*
- Adaptive Cruise Control (ACC) with Stop^{1*}†
- Dual-Zone Automatic Temperature Control*
- Four pre-wired auxiliary switches*
- Power, heated mirrors*
- Auto-dimming rearview mirror

CONNECTIVITY

- Uconnect[®] 4C NAV with 8.4-inch touchscreen*
- Apple CarPlay^{2*}
- Android Auto^{TM2*}
- SiriusXM radio^{3*}
- SiriusXM Guardian^{4*}
- SiriusXM Traffic^{5*}
- SiriusXM Travel Link^{5*}

UTILITY

- Trail Rail[™] Cargo Management System*
- Modular Seatback Jeep[®] Utility Grid System*
- Rear in-floor storage bin
- Lockable glove box
- Lockable centre console
- Wash-out interior with removable carpet

AUDIO & TECHNOLOGY

- Alpine[®] Premium Sound System*
- Push-button start
- Remote Start System^{6*}
- Keyless Enter 'n Go^{™*}
- LED Lighting Group*
- 7-inch full-colour Driver Information Display*

**CAPABILITY**

- Rock-Trac[®] 4x4 System*
- Selec-Trac[®] Full-Time 4x4 System*
- Command-Trac[®] 4x4 System
- Tru-Lok[®] locking differentials*
- Dana[®] axles
- Rock rails*
- Steel bumpers*
- Skid plates
- Trailer Tow and HD Electrical Group*

DRIVETRAIN

- 3.6L Pentastar[™] V6 engine with Engine Stop/Start (ESS) technology
- 3.6L Pentastar V6 engine with eTorque*
- 2.0L Turbo engine with ESS*
- 2.0L Turbo engine with eTorque* (late availability)
- 3.0L EcoDiesel V6 engine with ESS* (late availability)
- 8-speed automatic transmission*
- 6-speed manual transmission

OPEN AIR

- Sunrider[®] Soft Top
- Freedom Top[®] Modular Hardtop*
- Sky One-Touch[™] Power Top*
- Removable¹⁹ doors
- Fold-down¹⁹ windshield
- Dual Top Group*
- Tool kit for top/door removal¹⁹

SAFETY & SECURITY

- Electronic Stability Control (ESC)⁷
- Blind-Spot Monitoring^{1*}
- Rear Cross-Path Detection^{1*}
- Park-Sense[®] Rear Park Assist System^{1*}
- ParkView[®] Rear Back-Up Camera¹
- Sentry Key[®] antitheft engine immobilizer
- Hill Start Assist
- Advanced multistage driver and front-passenger air bags⁸
- Supplemental front-seat-mounted side air bags⁸

*Available. †All disclaimers and disclosures can be found on the back cover.



Sahara Unlimited with Grillz-painted mid-dash



Sahara® Unlimited with Black leather-trimmed interior

SCENE-MAKER

You're positioned to take in all the world has to offer and enjoy it to the fullest. Cabin appointments in Wrangler are refined and reflect just the right touch of historic Jeep® Brand design. Choose Wrangler Sahara® and you're riding with a robust array of standard creature comforts and technology features, including a large, 7-inch, full-colour Driver Information Display and an available Uconnect® 4C NAV with an 8.4-inch touchscreen that comes with a one-year SiriusXM radio³ subscription and a five-year SiriusXM Travel Link⁵ and SiriusXM Traffic⁵ subscription.





Rubicon® Unlimited with Black leather-trimmed interior and Redical mid-dash

LEGENDARY DNA Named after one of the toughest off-road trails in the world, Rubicon® offers iconic interior features as well. Its unique Redical Anodized or Silver Platinum mid-dash panel pays homage to the original Wrangler cabin design and adds Red accent stitching throughout. Available heated front seats and steering wheel add comfort, and the available Uconnect® 4C NAV with 8.4-inch full-colour touchscreen provides navigation⁹ as it entertains and informs.

7-INCH DRIVER INFORMATION DISPLAY

Front and centre in the gauge cluster, you'll find a wealth of scrollable vehicle data, including real-time transfer case status, song, artist and station playing, and more. Available.

CAPABILITY See the current settings for your transfer case, degree of pitch and roll, and steering-wheel position.

NAVIGATION⁹ Partnering with your available Uconnect 4C NAV, the Driver Information Display can show turn-by-turn directions as well as additional details that help you navigate your way.

PERFORMANCE Get real-time fuel economy data and see how many kilometres you can travel before you need to refuel.



VEHICLE DYNAMICS Are your tires properly inflated? You'll be notified if the pressure is low on any tire. Driving off-road? See a graphic depiction of how your wheels are articulating.

VEHICLE ALERTS You'll receive visual notification here for safety systems, such as available Full-Speed Forward Collision Warning with Crash Mitigation!

DEALER ePROCESS



NAVIGATION⁹ Looking for your next on- or off-road adventure? Uconnect[®] employs GPS Navigation⁹ for audible turn-by-turn directions, and detailed 3-D maps help to ensure you arrive on time. Use Voice Command¹⁰ and say the complete address to get directions quickly. Available.

PHONE/TEXT Make hands-free¹¹ phone calls or use your voice to send a text. Pair up to 10 Bluetooth[®] enabled phones. See a visual prompt of incoming calls or texts and send an automated reply.

4G WI-FI¹² HOTSPOT All along the way, you can upload and download, post, and search. Uconnect with Wi-Fi links compatible devices to the Web so passengers can stay connected. Available.



Uconnect[®] 4C NAV

An 8.4-inch full-colour touchscreen gives you command of a range of cabin comforts and features. Smartphone integration adds welcome convenience, with additional peace of mind provided by available SiriusXM Guardian⁴ and SiriusXM Traffic⁵ and SiriusXM Travel Link⁵. An available 4G Wi-Fi¹² Hotspot, premium pinch-to-zoom navigation⁹ and more are offered as well. Available on Sahara[®] and Rubicon[®].



Sahara[®] Unlimited in Hellayella



Display your favourite iPhone apps right on your Uconnect touchscreen. Access your iTunes library, call anyone in your contacts list or just ask Siri to help you out while you drive. Get directions, make calls and send messages, and connect to Apple Music, all without pausing your journey. Available.



Designed with safety and convenience in mind, Android Auto^{TM2} gives you the right information for the road ahead. Easily access your favourite music with Google Play Music, and get where you need to go with Google Maps. With your Google Assistant on Android Auto² you can keep your eyes on the road and your hands on the wheel while using your voice to help you with your day. Just say, "Ok, Google." Available.

Uconnect® + SiriusXM GUARDIAN

SIRIUSXM GUARDIAN⁴ Drive worry-free with SiriusXM Guardian — a premium suite of safety and convenience services that can be accessed in-vehicle or through the Uconnect® App. Includes a one-year trial. Available.

SIRIUSXM GUARDIAN⁴ SERVICES + UCONNECT® APP

- > **SOS CALL¹³** In the event of an incident, push the SOS button. You'll be connected to a SiriusXM Guardian agent who contacts 9-1-1, provides your location and stays on the line with you until help arrives.
- > **ROADSIDE ASSISTANCE CALL¹⁴** puts you in touch with an agent who can get you help while you're out on the road.
- > **SIRIUSXM GUARDIAN ASSISTANCE**
- > **LOCK/UNLOCK** your car from virtually anywhere.
- > **START YOUR CAR REMOTELY.¹⁵**
- > **FLASH THE LIGHTS** and sound the horn to help find your car.
- > Locate your car on a map using **VEHICLE FINDER.**
- > Send destinations to your navigation system using **SEND & GO.**
- > Receive alerts with **THEFT ALARM NOTIFICATION.¹⁶**
- > **STOLEN VEHICLE ASSISTANCE²¹**
- > **FAMILY DRIVE ALERTS** Boundary Alert notifies you when Wrangler travels outside of a set geographic area. Curfew Alert notifies you when Wrangler is driven outside a specific time frame. Speed Alert lets you set speed parameters, notifying you if exceeded. Valet Alert notifies you if it's driven outside a 0.4-km (1/4-mi) radius of a valet drop-off zone.

SIRIUSXM CONNECTED SERVICES⁴

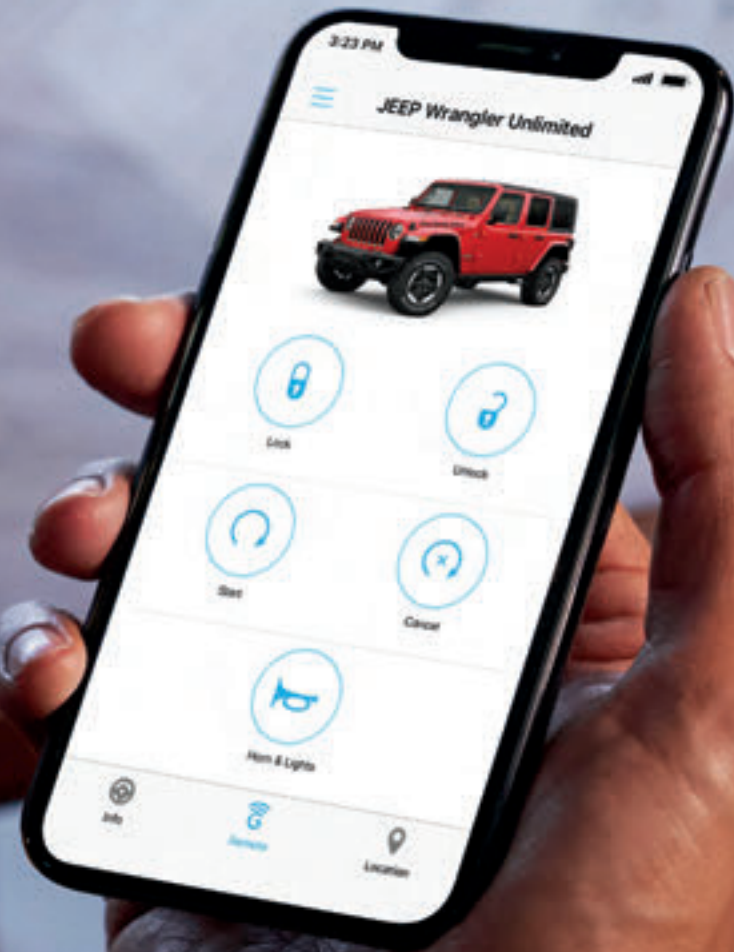



A



A



B



C

ORGANIZED TRAVELS

The many storage options found throughout Wrangler help keep your life on the road in order. You'll have important gear and items stowed in their proper place and easily accessible. Spend less time searching for items and more time having fun. Wrangler Unlimited offers 2,050 L (72.4 cu ft) of cargo room with the rear seats folded, so you can go all out when you get it all in.

A) TRAIL RAIL™ CARGO MANAGEMENT SYSTEM This versatile system lets you accessorize your cargo-carrying capability, optional on all Wrangler models. It includes aluminum rails on the tailgate and cargo floor, along with cargo anchors that lock into place (four anchors included with 2-door models, six with 4-door models). Then, choose to add further utility with the available Tailgate Table from Mopar®.

B) IN-FLOOR STORAGE BIN Store larger items, like computers and tools, within a hidden storage area under the cargo floor, behind the second row of seats. The lid secures when the swing gate is closed for convenient peace of mind.

C) MODULAR SEATBACK JEEP® UTILITY GRID SYSTEM Exclusive to and integrated into the Rubicon® front seatbacks, it allows for additional flexible storage options. Durable nylon woven straps accommodate available Modular Lightweight Load-carrying Equipment (MOLLE)-style bags. An available Mopar kit includes a set of three bags (small, medium and large), each with attachment straps and featuring the Jeep® Brand logo.

D) BINS AND POCKETS The two-tiered centre console has a main bin big enough to fit an iPad and a convenient top tray for smaller gear. Cup holders are sized to hold larger beverage containers and have a dedicated slot for cell phone or key fob storage.



D



D



D



Properly secure all cargo.

TURN UP THE VOLUME

ALPINE® PREMIUM SOUND SYSTEM

Immerse yourself in an exhilarating audio experience with nine speakers, including an overhead sound bar, all-weather subwoofer and 552-watt amplifier. The system is enhanced by Active Noise Cancellation. Available.



AUTHENTIC 4x4 AUTHORITY

JEEP® BRAND 4x4 SYSTEMS

COMMAND-TRAC® 4x4 SYSTEM This part-time, shift-on-the-fly system divides torque 50/50 between front and rear axles for tough traction and all-weather capability. The NV241 GII transfer case shifts smoothly from 2WD to 4WD at speeds up to 72 km/h (45 mph). For serious rock-crawling, its 2.72:1 low range ensures confidence. Standard on Sport and Sahara.®

SELEC-TRAC® FULL-TIME 4x4 SYSTEM With its proven, active 4WD transfer case, Selec-Trac® does all the thinking so you can concentrate on the scenery. Selec-Trac analyzes the situation for you and sends torque to the wheels with the most grip. The system provides continuous, optimum traction that effortlessly conquers snow, ice, rocks, mud and everything in between. The system's Smart Lock maintains constant 4WD action when you take to the trail or face challenging road conditions. Available on Sahara.

ROCK-TRAC® 4x4 SYSTEM Rubicon® rides with this extreme 4WD system. Its 4:1 low-gear ratio allows Rubicon to crawl at a low speed for greater control and increases the amount of torque available at the wheels. Standard on Rubicon.

Rubicon® Unlimited in Ocean Blue Metallic



TRAIL RATED®

Every Wrangler is engineered for exceptional off-road performance. Its Trail Rated® badge ensures that Wrangler can master the toughest road and weather conditions. In your Trail Rated Jeep® Wrangler, you're in command of exclusive, authentic 4WD capability. Confidently move forward to see what the world is really made of.

TESTED TO MASTER THE MOST CHALLENGING TERRAINS

MANOEUVRABILITY Every Wrangler is born with the athletic ability to navigate narrow gaps and emergency situations with precision steering, optimized wheelbases and a tight turning radius.

ARTICULATION Suspension systems enhance on- and off-road performance by maximizing flexibility, axle articulation and wheel travel. The articulation helps to keep all four wheels on the ground, providing greater control over rough terrain and obstacles.

WATER FORDING¹⁷ Traverse waterways with confidence, thanks to additional electrical and body seals, plus a high air-intake location. Wrangler has the capability to safely manage in up to 76 cm (30 in) of water. Always inspect all waterways before proceeding.

TRACTION Helps you maintain controlled forward motion on snowy back roads and over icy urban bridges. You can climb steep sand dunes and master muddy tracks. Your Trail Rated Wrangler has the traction within to master all kinds of topography and driving conditions.

GROUND CLEARANCE Head out knowing that your Trail Rated vehicle was designed to clear logs, rocks and uneven ground. Your undercarriage is protected too, with forged skid plates that cover valuable underbody elements.



PARTIAL TO POWER

CANADA'S BEST-SELLING ENGINE;¹⁸ the **3.6L PENTASTAR™ V6**, stars as the premier engine for Jeep® Wrangler. Its proven performance employs friction-reducing applications that ensure its smooth operation. The engine's welcome efficiencies are helped by the addition of Engine Stop/Start (ESS) technology while remaining a brawny performer, boasting 285 horsepower and 260 lb-ft of torque. Standard with a 6-speed manual, or available with an 8-speed automatic, transmission.

2.0L TURBO ENGINE Performs with V6 muscle, yet sips fuel as an I-4 should. Direct injection boosts power while reducing emissions, and ESS technology helps improve fuel economy. It achieves 270 horsepower and 295 lb-ft of torque, and, with its standard match to the 8-speed automatic transmission, you'll enjoy strong takeoffs and smooth highway coasting. Available.

eTORQUE TECHNOLOGY By including this efficient feature, the 3.6L Pentastar™ engine offers fuel-saving/energy-generating functions that include Auto Stop/Start, electric power assist, extended fuel shutoff, transmission shift management, intelligent battery charging and regenerative braking. Available.

THE ALL-NEW 3.0L ECODIESEL V6 ENGINE offers up to 260 horsepower and 442 lb-ft of torque for impressive performance and outstanding low-end strength. Now, you can take on the highway or off-road like never before. Matched to the 8-speed automatic transmission. Available on Unlimited models. Late availability.



PULLING POWER Wrangler Unlimited models can confidently tow up to 1,588 kg (3,500 lb) when properly equipped with the available Trailer Tow and HD Electrical Group. Wrangler is also ideal for towing behind an RV, so you can bring open-air off-road capability wherever you go.

8-SPEED AUTOMATIC TRANSMISSION

With smooth, quick efficiency, this transmission provides additional gears with no gain in weight, enhanced acceleration with reduced fuel consumption, and increased torque with added strength to pull. Available.



6-SPEED MANUAL TRANSMISSION

For those who prefer to really put themselves into every shift, this one's for you. It hands you low 1st and Reverse gears, which are great for off-roading, with a vent tube that can be moved to help safely traverse higher water fording¹⁷ levels. It comes standard, matched to either a Command-Trac® 4x4 System on Sport and Sahara® or paired with the Rock-Trac® 4x4 System on Rubicon.®



Sahara® Unlimited in Granite Crystal Metallic

Properly secure all cargo. Always tow within the vehicle's capacity.





REMOVABLE DOORS¹⁹ You're just a few bolts away from enjoying the full-on open-air experience. These removable doors are made of lightweight aluminum and designed to facilitate easy removal. They feature exposed door hinges with a T50 imprint calling out the Torx[®] bit (included) needed to remove door bolts, a quick-disconnect check strap, and detents to hold the door open.

FOLD-DOWN WINDSHIELD¹⁹ Wrangler is known the world over for its unique full-fledged wind-in-your-face driving experience. The aluminum-framed windshield is easy to fold down: remove the bolts, fold forward, secure to hood with available straps and go. The bump stops integrate the hold-down loops with washer spray nozzles for a clean appearance. The header bar with the rearview mirror and sun visors always stays in place when the windshield is folded down.



ONE WITH
NATURE



ROOF WITH A VIEW

Wrangler gives you multiple ways to take in more of the world. Three unique top styles allow you to experience the kind of open-air freedom that only Wrangler can deliver. So, decide how you want to get your top on, then get ready to take it right off!¹⁹



Sahara® Unlimited in Billet Silver Metallic

SUNRIDER® SOFT TOP



Use one hand to instantly expand your world. A smart easy-open spring-assist system makes the soft top easier than ever to fully or partially open. Zipperless removable windows¹⁹ complete the legendary wind-in-your-hair experience.

Rubicon® in Firecracker Red



SUNRIDER® SOFT TOP

Standard on all Wrangler models, with an easy-to-use zipperless design. Its simple operation allows the top to glide open with the help of spring-loaded support bars. Crafted from heavy-duty, waterproof cloth material. Available in Black or Heritage Tan.

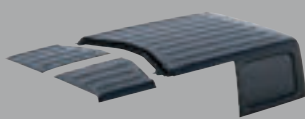

FREEDOM TOP® MODULAR HARDTOP

This three-piece hardtop is light and easy to remove!¹⁹ For a full open-air experience, you can remove all three sections or let in the sun by just removing the two front panels. Standard in Black on Sahara®. Available in Black on Sport and in Black and body-colour on Rubicon® models.

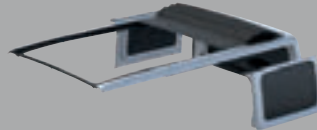

SKY ONE-TOUCH™ POWER TOP

Invite in the fresh air with the push of a button thanks to this power-to-open top. Open up even more with the easy-to-remove¹⁹ rear glass quarter panels. Available on Sahara and Rubicon Unlimited models.



FLIP BACK AND RELAX. Smart fabric management and an easy-to-use retraction handle let you bring in fresh air faster than ever with minimal effort.

GET A REALLY NICE TAN.

In addition to Black, the Sunrider® Soft Top is available in an attractive Heritage Tan, giving you a second choice of top colour.

DEALER PROCESS

FREEDOM TOP® MODULAR HARDTOP



This available three-piece hardtop is lightweight and easy to remove.¹⁹ A complimentary tool kit is included with every hardtop Wrangler. The kit includes a handy case that holds all the tools you need to remove the hardtop.

Sahara® Unlimited in Billet Silver Metallic

SKY ONE-TOUCH™ POWER TOP



REMOVABLE PANELS¹⁹ They're lightweight and easier than ever to remove. Choose to take off just the front panel, or all three, to customize your fresh-air experience.¹⁹

AVAILABLE BODY-COLOUR
Match your Freedom Top® panels to your body-colour on Sahara® and Rubicon® models.



OPEN AIR AT THE TOUCH OF A BUTTON

The Sky One-Touch™ Power Top features a unique sliding function that allows deployment at speeds up to 88 km/h (55 mph). For even more air, the rear quarter windows are easily removable within seconds.¹⁹ No more planning ahead to pull over for sudden rainstorms. This changes open-air freedom forever. Available on Sahara and Rubicon Unlimited models.



DEALER  Sahara Unlimited in Bright White

A SOLID FOUNDATION

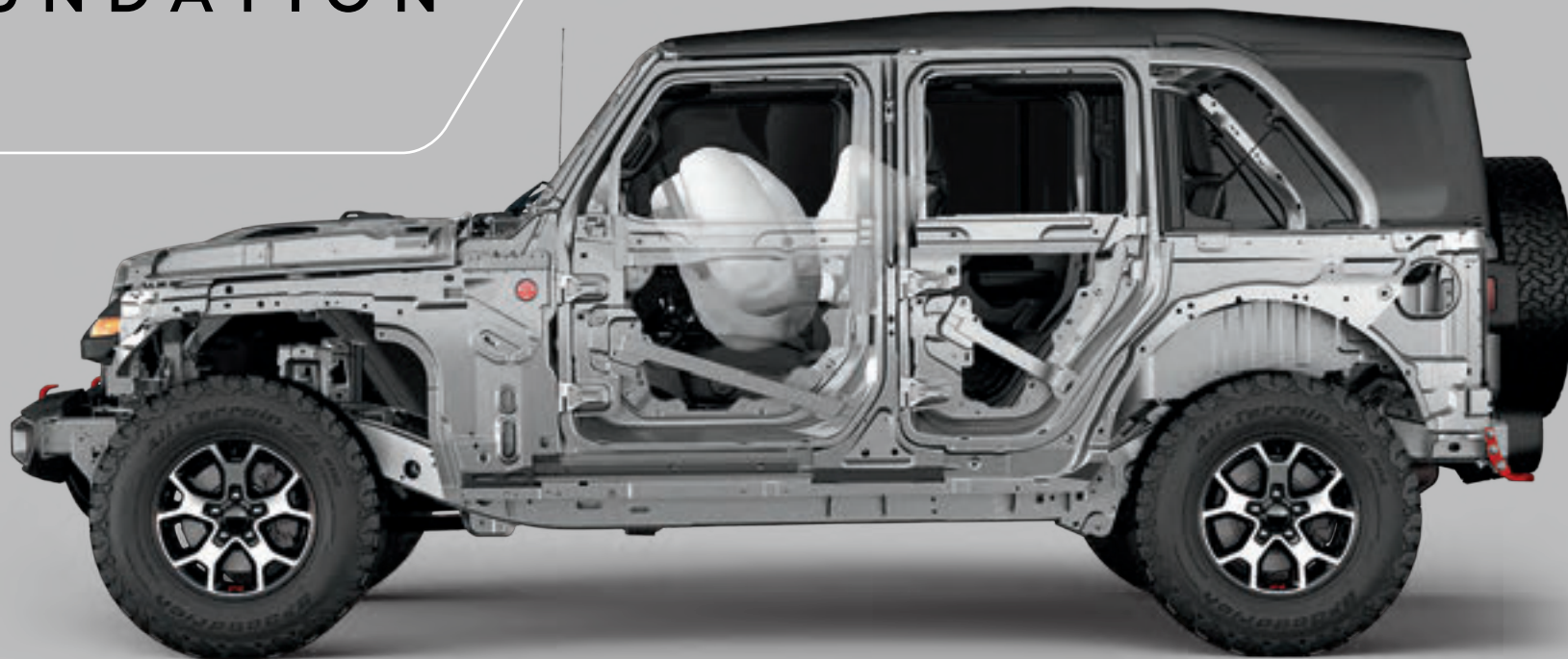

BODY STRENGTH The exceptionally solid safety cage consists of high-strength steel paired with lightweight aluminum, making Wrangler lighter in weight while still providing a very strong chassis. Standard.

ADVANCED MULTISTAGE AIR BAGS⁸ When a crash is detected, these air bags deploy nearly instantaneously, providing occupant protection that's matched to crash severity. Active vents exhaust air bags at appropriate rates, depending on impact. Standard.

SUPPLEMENTAL FRONT-SEAT-MOUNTED SIDE AIR BAGS⁸ Deploying from the outboard side of each front seat, these air bags enhance the protection of the driver and front-seat passenger in certain impacts. Standard.



SENTRY KEY[®] ENGINE IMMOBILIZER A unique, embedded key code matched only to your vehicle helps keep your Wrangler safe where you parked it. Standard.



BLIND-SPOT MONITORING¹ AND REAR CROSS-PATH DETECTION¹ Maintain a safe perimeter with the help of these sensor systems. Illuminated icons notify you when side or rear blind spots are encroached. Available.



PARK-SENSE[®] REAR PARK ASSIST SYSTEM¹ Works in tandem with the ParkView[®] Rear Back-Up Camera¹ to display previously hidden objects, bringing them to your attention on-screen and with an audible warning so you have time to react. At speeds below 6 km/h (4 mph), the system will automatically bring the vehicle to a stop if an object is detected. Available.



ELECTRONIC STABILITY CONTROL (ESC)⁷ A vehicle-wide network of safety sensors helps maintain vehicle control, providing instant aid should it detect you're veering off your intended path. ESC⁷ coordinates Electronic Roll Mitigation (ERM), Antilock Brake System (ABS) and Brake Assist, All-Speed Traction Control, and available Trailer Sway Control (TSC), sending them into action when needed. Standard.

ENHANCED ACCIDENT RESPONSE SYSTEM (EARS) This system makes it easier for emergency personnel to see and reach occupants in the event of an accident, turning on interior lighting, flashing hazard lamps and unlocking power doors after air bag deployment. Standard.

DEALER APPROVES

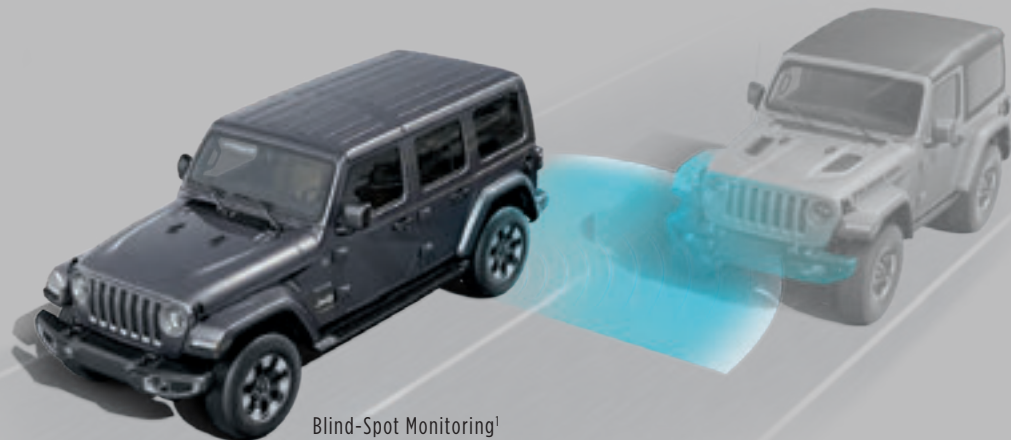

Blind-Spot Monitoring¹

HILL START ASSIST (HSA) AND HILL DESCENT CONTROL (HDC) HSA works to prevent Wrangler from rolling when starting on an uphill gradient. HDC is packaged with the 8-speed automatic transmission, helping Wrangler navigate steep declines at a steady speed. Available.

SAFETYTEC™ GROUP This complete package uses active sensors to help you stay aware of your surroundings. It includes Blind-Spot Monitoring¹ and Rear Cross-Path Detection,¹ Park-Sense® Rear Park Assist System,¹ and bright LED taillamps. Available.

LED LIGHTING GROUP Maintain a unique — and safe — presence after dark, and add extra visual security during the day. The traditional round headlamps are equipped with unique daylight running lamps (DRLs), and the group's LED headlamps, taillamps and front LED fog lamps enhance visibility during inclement weather. Available.

UCONNECT® INTEGRATED VOICE COMMAND¹⁰ WITH BLUETOOTH® Multitasking is the way of today's world, even when you're on the road.¹¹ This important safety feature allows drivers to safely send, reply or listen to a text, take or make phone calls,¹¹ and more while keeping both hands on the wheel. Standard.

SIRIUSXM GUARDIAN⁴ WITH SOS CALL¹³ AND ROADSIDE ASSISTANCE CALL¹⁴ Provides help in the event of an emergency while out on the road. Press the SOS button on the rearview mirror to be connected to an agent who can direct emergency assistance to your location. Press the Assist button on your rearview mirror followed by Roadside Assistance on your touchscreen to speak to an agent who can send roadside help. Available.



PARKVIEW® REAR BACK-UP CAMERA¹ When the vehicle is in Reverse, the Uconnect® screen displays a wide-angle view of what's immediately behind your vehicle. You'll see objects behind you that may have been out of your sight line — all in good time to react. On-screen dynamic grid lines help you see your back-up path or line up a trailer to your hitch. Standard.



TRAILER SWAY CONTROL (TSC) Crosswinds and traffic hold no sway over you and your payload. As part of Electronic Stability Control,⁷ TSC helps keep you and the toys you tow safely on course. Standard.

When it comes to your well-being on the road, Wrangler is ready and willing to stand as a constant guardian. Wrangler envelops you with more than 75 standard and available Safety & Security features. Sensors and cameras keep watch around your perimeter for complete peace of mind.



Rear Cross-Path Detection¹



Park-Sense® Rear Park Assist System¹





OFF-ROAD PAGES Access real-time performance data like suspension travel or keep an eye on your tilt-and-pitch. In-depth vehicle diagnostics, including wheel turn, articulation and transmission temperature, all help to provide an optimized experience. Available.



Rubicon® with Black leather-trimmed interior with embroidered Rubicon logo, Rubicon Red accent stitching and Redical mid-dash

RUBICON®

STANDARD

- 3.6L Pentastar™ V6 engine with Engine Stop/Start (ESS) technology and 6-speed manual transmission
- Rock-Trac® 4x4 System
- 3rd-generation Dana® 44 heavy-duty axles with Tru-Lok® front and rear locking differentials
- Performance suspension system
- High-clearance front fender flares
- Rock rails
- Vented hood with Rubicon® decal
- Front and rear tow hooks in Red
- Unique front and rear bumpers with Grey bezels
- Grey grille inserts
- Black fuel-filler door
- Skid plates for fuel tank and transfer case
- Sway bar disconnect
- Automatic halogen headlamps and fog lamps
- Sunrider® Soft Top in Black vinyl with deep-tint windows
- Full-framed removable¹⁹ doors
- 17-inch machined aluminum wheels with Black pockets
- 33-inch BFGoodrich® Off-Road tires
- Full-size spare tire
- Cloth seats in Black with Rubicon logo, Red accent stitching, and either Redical Anodized or Silver Platinum mid-dash
- Push-button start
- Cruise control
- Leather-wrapped steering wheel
- Power windows and locks
- Power, heated mirrors
- Universal garage door opener²⁰
- 7-inch, full-colour Driver Information Display
- Uconnect® 4 with 7-inch touchscreen and SiriusXM radio³
- Apple CarPlay² integration
- Android Auto™² compatibility
- Dual-Zone Automatic Temperature Control

STANDARD (continued)

- 8-speaker sound system with overhead sound bar
- ParkView® Rear Back-Up Camera¹
- Electronic Stability Control (ESC)⁷ and Trailer Sway Control (TSC)
- Hill Start Assist (HSA) and Electronic Roll Mitigation (ERM)
- Engine block heater
- Advanced multistage driver and front-passenger air bags⁸
- Supplemental front-seat-mounted side air bags⁸
- Tire Pressure Monitoring Display
- Sentry Key® anti-theft engine immobilizer
- Security alarm
- 12-volt outlet and 115-volt auxiliary power outlet
- Modular Seatback Jeep® Utility Grid System
- Full centre console and rear in-floor storage bin
- Torx® tool kit for top and door removal¹⁹
- Wash-out interior with removable carpet
- Rear 60/40 split-folding seats (Unlimited)

AVAILABLE

- 2.0L Turbo engine with ESS
- 2.0L Turbo engine with eTorque (late availability)
- 3.6L Pentastar V6 engine with eTorque
- 3.0L EcoDiesel V6 engine with ESS (late availability; Unlimited models only)
- 8-speed automatic transmission
- Body-colour fender flares
- Sky One-Touch™ Power Top with 1-touch operation and removable¹⁹ rear quarter panels
- Freedom Top® Black or body-colour 3-piece modular hardtop with rear wiper/washer, rear defroster and Freedom Panel storage bag
- Mopar® Hardtop Headliner
- Premium Black or Heritage Tan Sunrider Soft Top with upgraded fabric and quieter performance
- Keyless Enter 'n Go™ proximity entry
- Remote Start System⁶

AVAILABLE (continued)

- Alpine® Premium Sound System with 9 speakers, including an all-weather subwoofer, 552-watt amplifier and 220-amp alternator
- Trail Rail™ Cargo Management System
- Mopar All-Weather Floor Mats
- Jeep Trail Rated® Kit – tow strap, gloves, D-ring and bag

STEEL BUMPER GROUP: Winch-capable front steel bumper with integrated fog lamps, removable end caps and steel rear bumper (must have LED Lighting Group)

DUAL TOP GROUP: Black Freedom Top 3-piece hardtop and premium Black Sunrider Soft Top (Wrangler Unlimited only)

COLD WEATHER GROUP: Heated steering wheel, heated front seats and Remote Start System⁶

UCONNECT® 4C NAV AND SOUND GROUP: Uconnect 4C NAV with 8.4-inch touchscreen, GPS Navigation² Bluetooth⁹ Apple CarPlay²; Android Auto²; AM/FM radio, HD radio, SiriusXM radio³ (1-year trial subscription), SiriusXM Guardian⁴ (1-year trial subscription), SiriusXM Traffic⁵ (5-year trial subscription), SiriusXM Travel Link⁵ (5-year trial subscription), Alpine Premium Sound System, 4G Wi-Fi Hotspot¹² and auto-dimming rearview mirror

LED LIGHTING GROUP: Front LED fog lamps, LED reflector headlamps, LED taillamps and daytime running lamps with LED accents

TRAILER TOW AND HD ELECTRICAL GROUP: Class II hitch receiver, 4- and 7-pin wiring harness, 240-amp alternator, 700-amp maintenance-free battery, and 4 pre-wired auxiliary switches

SAFETYTEC™ GROUP: Blind-Spot Monitoring¹ and Rear Cross-Path Detection¹; Park-Sense® Rear Park Assist System¹; and LED taillamps

ADVANCED SAFETY GROUP: Full-Speed Forward Collision Warning Plus¹; Auto High-Beam Headlamp Control and Adaptive Cruise Control with Stop¹

SMOKER'S GROUP: Removable ashtray and lighter

INTERIORS

- 1) Embossed Cloth in Black with embroidered Rubicon logo, Rubicon Red accent stitching, and either painted Redical or Silver Platinum mid-dash, depending on exterior paint colour (standard)
- 2) Leather-trimmed in Black with embroidered Rubicon logo, Rubicon Red accent stitching, and either painted Redical or Silver Platinum mid-dash, depending on exterior paint colour (available)
- 3) Leather-trimmed in Dark Saddle with embroidered Rubicon logo, Light Tungsten accent stitching, and painted Silver Platinum mid-dash (available)

WHEELS

- 1) 17-inch machined aluminum with Black pockets (standard)
- 2) 17-inch aluminum Mid-Gloss Black with polished lip (available)



Rubicon® Unlimited in Billet Silver Metallic with optional body-colour fender flares and Steel Bumper Group



SAHARA®

STANDARD

- 3.6L Pentastar™ V6 engine with Engine Stop/Start (ESS) technology and 6-speed manual transmission
- Command-Trac® 4x4 System
- Dana® axles
- Skid plates for fuel tank and transfer case
- Front and rear tow hooks
- Automatic halogen headlamps and fog lamps
- Black Freedom Top® hardtop
- Full-framed removable¹⁹ doors
- 18-inch aluminum wheels with painted Granite Crystal spokes
- 255/70R18 Bridgestone® All-Season tires
- Full-size spare tire
- Side steps
- Body-colour fender flares
- Unique front and rear bumpers with Silver bezels
- Silver grille inserts
- Cloth seats with Sahara® logo
- Grillz-painted mid-dash
- Push-button start
- Cruise control
- 7-inch full-colour Driver Information Display
- Uconnect® 4 with 7-inch touchscreen and SiriusXM radio³
- Apple CarPlay² integration
- Android Auto™² compatibility
- Dual-Zone Automatic Temperature Control
- 8-speaker sound system with overhead sound bar
- ParkView® Rear Back-Up Camera¹
- Electronic Stability Control (ESC)⁷ and Trailer Sway Control (TSC)
- Hill Start Assist (HSA) and Electronic Roll Mitigation (ERM)
- Advanced multistage driver and front-passenger air bags⁵
- Supplemental front-seat-mounted side air bags⁸

STANDARD (continued)

- Tire Pressure Monitoring Display
- Sentry Key® anti-theft engine immobilizer
- Security alarm
- 12-volt outlet and 115-volt auxiliary power outlet
- Universal garage door opener²⁰
- Full centre console and rear in-floor storage bin
- Torx® tool kit for top and door removal¹⁹
- Wash-out interior with removable carpet
- Rear 60/40 split-folding seats
- Engine block heater

AVAILABLE

- 2.0L Turbo engine with ESS
- 2.0L Turbo engine with eTorque (late availability)
- 3.6L Pentastar V6 engine with eTorque
- 3.0L EcoDiesel V6 engine with ESS (late availability)
- 8-speed automatic transmission
- Selec-Trac® Full-Time 4x4 System
- Sky One-Touch™ Power Top with 1-touch operation and removable¹⁹ rear quarter panels
- Freedom Top body-colour 3-piece modular hardtop with rear wiper/washer, rear defroster and Freedom Panel storage bag
- Keyless Enter 'n Go™ proximity entry
- Remote Start System⁶
- Antispin differential rear axle
- Mopar® Hardtop Headliner
- Premium Black or Heritage Tan Sunrider® Soft Top with upgraded fabric and quieter performance
- Alpine® Premium Sound System with 9 speakers, including an all-weather subwoofer, 552-watt amplifier and 220-amp alternator
- Trail Rail™ Cargo Management System
- Mopar All-Weather Floor Mats
- Jeep® Trail Rated® Kit – tow strap, gloves, D-ring and bag

AVAILABLE (continued)

DUAL TOP GROUP: Black Freedom Top 3-piece hardtop and premium Black Sunrider Soft Top

TRAILER TOW AND HD ELECTRICAL GROUP: Class II hitch receiver, 4- and 7-pin wiring harness, 240-amp alternator, 700-amp maintenance-free battery, and 4 pre-wired auxiliary switches

COLD WEATHER GROUP: Heated steering wheel, heated front seats and Remote Start System⁶

ELECTRONIC INFOTAINMENT GROUP: Uconnect 4C NAV with 8.4-inch touchscreen, GPS Navigation³, Bluetooth[®], Apple CarPlay², Android Auto², AM/FM radio, HD radio, SiriusXM radio³ (1-year trial subscription), SiriusXM Guardian⁴ (1-year trial subscription), SiriusXM Traffic⁵ (5-year trial subscription), SiriusXM Travel Link⁵ (5-year trial subscription), Alpine Premium Sound System, 4G Wi-Fi Hotspot¹² and auto-dimming rearview mirror

SAFETYTEC™ GROUP: Blind-Spot Monitoring¹ and Rear Cross-Path Detection¹; Park-Sense® Rear Park Assist System¹; and LED taillamps

ADVANCED SAFETY GROUP: Full-Speed Forward Collision Warning Plus¹; Auto High-Beam Headlamp Control and Adaptive Cruise Control with Stop¹

LED LIGHTING GROUP: Front LED fog lamps, LED reflector headlamps, LED taillamps and daytime running lamps

SMOKER'S GROUP: Removable ashtray and lighter

INTERIORS

- 1) Cloth with Peak embossment in Black with tonal stitching and Grillz-painted mid-dash (standard)
- 2) Cloth with Peak embossment in Heritage Tan with tonal stitching and Grillz-painted mid-dash (standard)
- 3) Leather-trimmed in Black with embroidered Sahara logo, Light Tungsten accent stitching and premium-wrapped mid-dash (available)
- 4) Leather-trimmed in Dark Saddle with embroidered Sahara logo, Light Tungsten accent stitching and premium-wrapped mid-dash (available)



WHEELS

- 1) 18-inch aluminum with painted Granite Crystal spokes (standard)
- 2) 18-inch aluminum face with painted Tech Grey windows (available)



Sahara® Unlimited in Bright White with optional body-colour Freedom Top®

DEP
DEALER ePROCESS

SPORT

STANDARD / SPORT

- 3.6L Pentastar™ V6 engine with Engine Stop/Start (ESS) technology and 6-speed manual transmission
- Command-Trac® 4x4 System
- Dana® axles
- Skid plates for fuel tank and transfer case
- Front and rear tow hooks
- Halogen headlamps and fog lamps
- Sunrider® Soft Top in Black vinyl
- Full-framed removable® doors
- 17-inch Low-Gloss Black steel wheels
- 245/75R17 Michelin® All-Season tires
- Full-size spare tire
- Cloth seating with Silver Platinum mid-dash
- Tilt/telescoping steering column
- Push-button start
- Cruise control
- 3.5-inch, monotone Driver Information Display
- Uconnect® with 5-inch touchscreen, AM/FM radio, Bluetooth®, Voice Command™ and hands-free™ calling
- 8-speaker sound system with overhead sound bar
- ParkView® Rear Back-Up Camera¹
- Electronic Stability Control (ESC)² and Trailer Sway Control (TSC)
- Hill Start Assist (HSA) and Electronic Roll Mitigation (ERM)
- Advanced multistage driver and front-passenger air bags⁵
- Supplemental front-seat-mounted side air bags⁵
- Tire Pressure Monitoring Display
- Sentry Key® anti-theft engine immobilizer
- 12-volt outlet
- Full centre console and rear in-floor storage bin
- Torx® tool kit for top and door removal¹⁹
- Wash-out interior with removable carpet
- Engine block heater

STANDARD / SPORT S SPORT FEATURES, PLUS:

- 17-inch Tech Silver Metallic aluminum wheels
- Leather-wrapped steering wheel
- Air conditioning
- Power windows and locks
- Power, heated mirrors
- Automatic headlamps
- Deep-tint sunscreen windows
- Security alarm
- Sun visors with illuminated vanity mirror

AVAILABLE / SPORT

- Antispin differential rear axle
- Air conditioning
- SiriusXM radio³ with 1-year trial subscription
- Deep-tint sunscreen windows, rear and quarter

AVAILABLE / SPORT S

- 3.0L EcoDiesel V6 engine with ESS (late availability; Unlimited models only)
- Antispin differential rear axle
- Side steps
- Alpine® Premium Sound System with 9 speakers, including an all-weather subwoofer, 552-watt, 12-channel amplifier and 220-amp alternator
- Premium Black or Heritage Tan Sunrider Soft Top with upgraded fabric and quieter performance

CONVENIENCE GROUP: Universal garage door opener²⁰ and Remote Start System⁶

TECHNOLOGY GROUP: Uconnect 4 with 7-inch touchscreen and SiriusXM radio; Bluetooth, Apple CarPlay; Android Auto,™² AM/FM radio, audio input jack, air conditioning with Automatic Temperature Control and 7-inch full-colour Driver Information Display

SAFETYTEC™ GROUP: Blind-Spot Monitoring¹ and Rear Cross-Path Detection¹; Park-Sense® Rear Park Assist System¹; and LED taillamps

ADVANCED SAFETY GROUP: Full-Speed Forward Collision Warning Plus¹ and Adaptive Cruise Control with Stop¹

AVAILABLE / SPORT AND SPORT S

- 2.0L Turbo engine with ESS
- 2.0L Turbo engine with eTorque (late availability)
- 3.6L Pentastar V6 engine with eTorque
- 8-speed automatic transmission
- Trac-Lok® limited-slip differential
- Freedom Top® Black 3-piece modular hardtop with rear wiper/washer, rear defroster and Freedom Panel storage bag
- Mopar® Hardtop Headliner
- Trail Rail™ Cargo Management System (not available on Sport)
- Mopar All-Weather Floor Mats
- Jeep Trail Rated® Kit – tow strap, gloves, D-ring and bag

DUAL TOP GROUP: Black Freedom Top 3-piece hardtop and premium Black Sunrider Soft Top (Wrangler Unlimited only)

TRAILER TOW AND HD ELECTRICAL GROUP: Class II hitch receiver, 4- and 7-pin wiring harness, 240-amp alternator, 700-amp maintenance-free battery and 4 pre-wired auxiliary switches

COLD WEATHER GROUP: Heated steering wheel, heated front seats and Remote Start System⁶

SMOKER'S GROUP: Removable ashtray and lighter

LED HEADLAMP AND FOG LAMP GROUP: Front LED fog lamps and LED reflector headlamps

INTERIORS

- 1) Cloth with embossment in Black with tonal stitching and Silver Platinum-painted mid-dash (standard)
- 2) Cloth with embossment in Heritage Tan with tonal stitching and Silver Platinum-painted mid-dash (standard)

WHEELS

- 1) 17-inch Low-Gloss Black steel (standard)
- 2) 17-inch Tech Silver Metallic aluminum (standard on Sport S)
- 3) 17-inch Granite Crystal machined aluminum (available on Sport S)



Sport S Unlimited in Firecracker Red with optional 17-inch aluminum wheels

DEP
DEALER ePROCESS

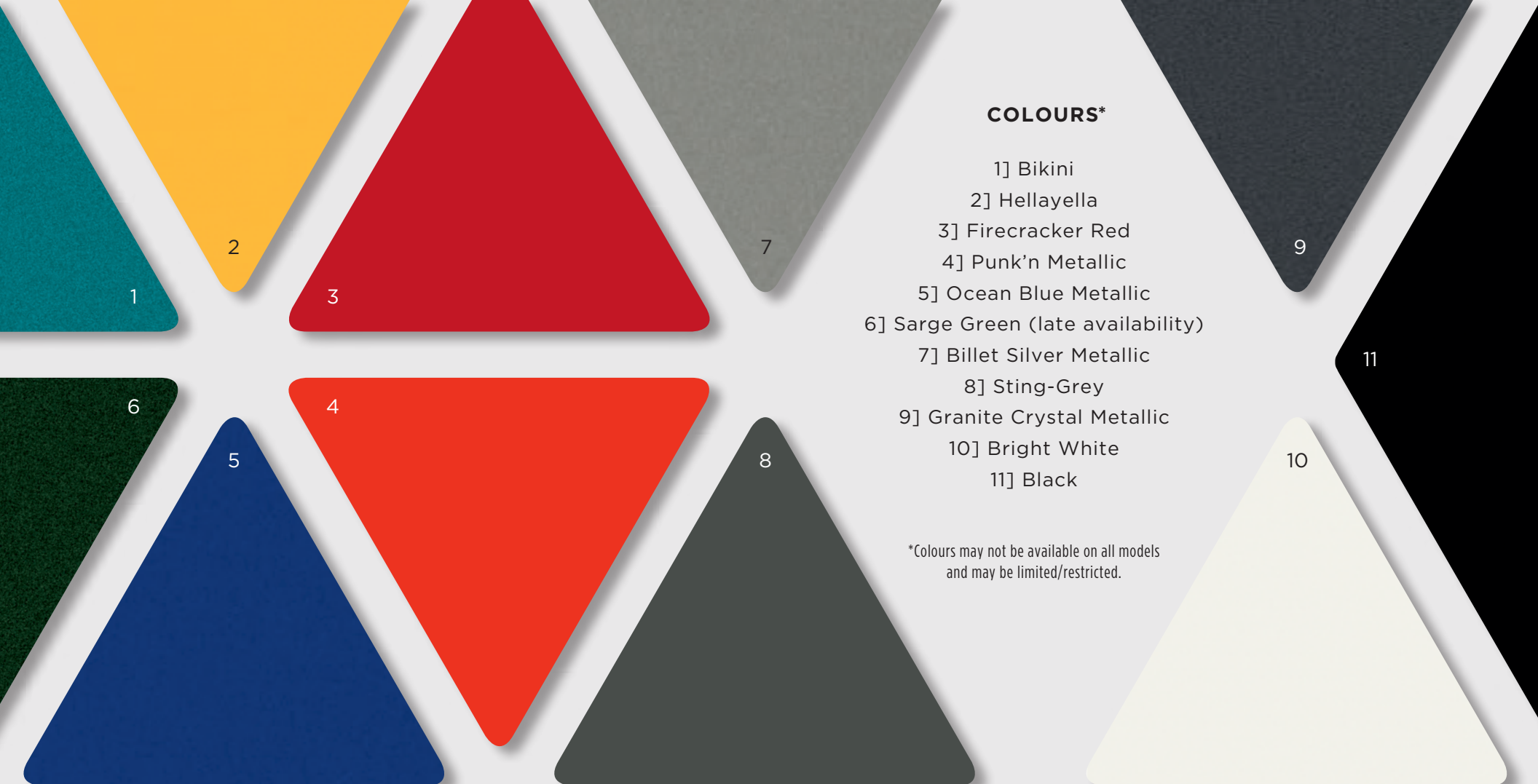

COLOURS*

- 1] Bikini
- 2] Hellaella
- 3] Firecracker Red
- 4] Punk'n Metallic
- 5] Ocean Blue Metallic
- 6] Sarge Green (late availability)
- 7] Billet Silver Metallic
- 8] Sting-Grey
- 9] Granite Crystal Metallic
- 10] Bright White
- 11] Black

*Colours may not be available on all models and may be limited/restricted.

SUNRIDER® SOFT TOP

Black

Heritage Tan



FREEDOM TOP® MODULAR HARDTOP

Black
Standard on Sahara®
Optional on Sport and Rubicon®

Body-Colour
Optional on Sahara and Rubicon



SKY ONE-TOUCH™ POWER TOP

Black
Optional on Sahara Unlimited
and Rubicon Unlimited





2 DR

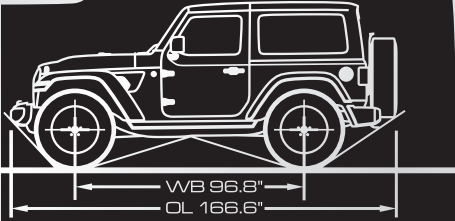

4 DR

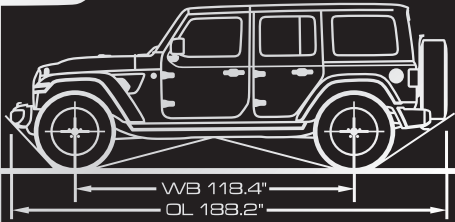

WATER FORDING

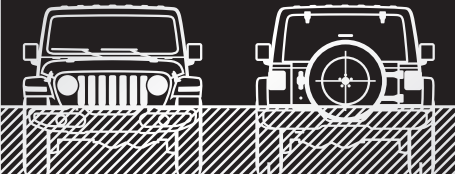

30" AT 5 MPH

TR 64.4", OW 73.9"



MADE IN THE U.S.A.

DEVELOPED IN

AUBURN HILLS, MI

BUILT IN

TOLEDO, OH



SINCE 1941

SPECIFICATIONS

EXTERIOR DIMENSIONS

(2-door / 4-door Rubicon® with soft top; millimetres (inches) unless otherwise noted)

| | |
|-----------------------------------|-----------------------------|
| Wheelbase | 2460 (96.8) / 3008 (118.4) |
| Overall Length (with spare tire) | 4237 (166.8) / 4785 (188.4) |
| Overall Width (without mirrors) | 1875 (73.8) |
| Track (front / rear) | 1598 (62.9) |
| Height | 1868 (73.6) |
| Ground Clearance | 274 (10.8) |
| Approach Angle (degrees) | 44 / 43.9 |
| Breakover Angle (degrees) | 27.8 / 22.6 |
| Departure Angle (degrees) | 37 |
| Water Forging Depth ¹⁷ | 762 (30) |

INTERIOR DIMENSIONS

(2-door / 4-door with soft top; millimetres (inches) unless otherwise noted)

| | |
|---|---------------------------|
| Seating Capacity: 2-door (front / rear) | 2 / 2 adults |
| 4-door (front / rear) | 2 / 3 adults |
| Headroom: front | 1083 (42.6) |
| rear | 1059 (41.7) |
| Legroom: front | 1038 (41.2) |
| rear | 904.2 (35.7) / 974 (38.3) |
| Shoulder Room: front | 1417 (55.7) |
| rear | 1458 (57.7) / 1417 (55.7) |
| Hip Room: front | 1370 (53.9) |
| rear | 1143 (45) / 1440 (56.7) |
| Cargo Volume, L (cu ft): | |
| rear seat up | 365 (12.9) / 898 (31.7) |
| rear seat folded | 1328 (46.9) / 2050 (72.4) |

CAPACITIES / WEIGHTS

(2-door / 4-door Rubicon; kilograms (pounds) unless otherwise noted)

| | |
|------------------------------------|---------------------------|
| Fuel Tank, L (imp gal) | 70 (15.4) / 81 (17.9) |
| Base Curb Weight: 2.0L | 1819 (4010) / 1960 (4320) |
| 3.6L | 1801 (3970) / 1912 (4215) |
| Gross Vehicle Weight Rating (GVWR) | 2381 (5250) / 2631 (5800) |

TOWING DATA

(2-door / 4-door; kilograms (pounds) unless otherwise noted)

| | |
|---|--------------------------|
| Towing Capacity (when properly equipped): | |
| 2.0L | 907 (2000) / 1588 (3500) |
| 3.6L | 907 (2000) / 1588 (3500) |
| Tongue Load Limit | 90.7 (200) / 158.7 (350) |

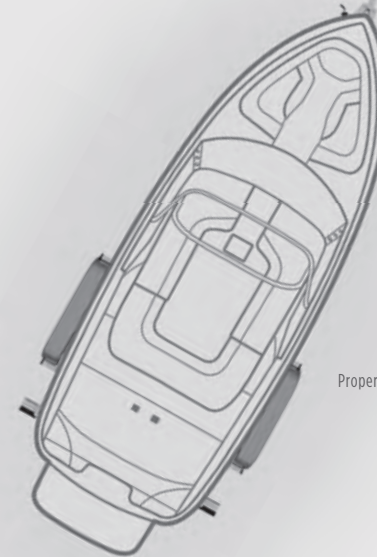

Properly secure all cargo. Always tow within vehicle's capacity.

jeep.ca



Check us out on: instagram.com/jeepca



Like us on: facebook.com/jeepcanada



Follow us on: twitter.com/jeepcanada

DEALER ePROCESS



ABOUT THIS CATALOGUE. Since the time of printing, some of the information you'll find in this catalogue may have been updated. Ask your retailer for details. Some of the equipment shown or described throughout this catalogue is available at extra cost. Specifications, descriptions, illustrative materials and all competitive comparisons contained herein are as accurate as known at the time this publication was approved for printing. FCA Canada Inc. reserves the right to make changes at any time without notice and without incurring obligation. For the price of the model with the equipment you desire or verification of specifications contained herein, see your Chrysler, Jeep, Dodge and Ram retailer.

©2019 FCA Canada Inc. All rights reserved. Chrysler, Dodge, Jeep, Ram, SRT, the Jeep grille, Mopar, Mopar Vehicle Protection, Command-Trac, Freedom Top, Park-Sense, ParkView, Rock-Trac, Rubicon, Sahara, Sentry Key, Selec-Trac, Trac-Lok, Trail Rated, Tru-Lok, Uconnect and Wrangler are registered trademarks and Keyless Enter 'n Go, Pentastar, Send & Go, Sky One-Touch, SafetyTec and Trail Rail are trademarks of FCA Canada, Inc.

Alpine and the Alpine logo are registered trademarks of Alpine Electronics, Inc. All rights reserved. Google, Android Auto and Google Play are trademarks of Google LLC. iPhone, iTunes, iPad and Siri are registered trademarks of Apple Inc. BF Goodrich is a registered trademark of Goodrich Corporation. Bluetooth is a registered trademark of Bluetooth SIG, Inc. Bridgestone and any Bridgestone products or service names are trademarks or registered trademarks of Bridgestone Corporation. Cummins is a registered trademark of Cummins, Inc. Dana is a registered trademark of Dana Corporation. Facebook is a registered trademark of Facebook, Inc. Instagram is a registered trademark of Instagram, Inc. Michelin is a registered trademark of Michelin North America, Inc. SiriusXM Connected Vehicles Services Inc., Sirius, XM, SiriusXM and SiriusXM Guardian and all related marks and logos are trademarks of SiriusXM Radio Inc. Sunrider is a registered trademark of Bestop, Inc. Torx is a registered trademark of Acument Intellectual Properties, LLC. The Twitter name, logo, Twitter T, Tweet and Twitter bird are service marks of Twitter, Inc. in the United States and other countries.

MOPAR VEHICLE PROTECTION. FCA Canada Inc. has a vested interest in your satisfaction and owner experience with your new vehicle. Mopar Vehicle Protection offers extended service and maintenance plans to help ensure you'll enjoy your vehicle for many years down the road — for just pennies a day. For more information on comprehensive vehicle coverage, see your local Chrysler, Jeep, Dodge and Ram retailer or call (800) 465-2001.

WARRANTIES. 2020 Chrysler, Jeep, Dodge and Ram vehicles are backed by a 5-year or 100,000-kilometre fully transferable Powertrain Limited Warranty* with \$0 deductible plus 24-hour roadside assistance¹. SRT vehicles are backed by a 3-year or 60,000-kilometre fully transferable Powertrain Limited Warranty* with \$0 deductible plus 24-hour roadside assistance. Basic Warranty coverage is for 3 years or 60,000 kilometres. Rust-through coverage on all body sheet metal is for 3 years. The Cummins Turbo Diesel engine is protected by a separate Limited Warranty, covering the engine for 5 years or 160,000 kilometres. The EcoDiesel engine is backed by a 5-year or 100,000-kilometre fully transferable Powertrain Limited Warranty* with \$0 deductible plus 24-hour roadside assistance².

*Whichever comes first. Some conditions may apply. ¹The 5-Year/100,000-Kilometre Powertrain Limited Warranty does not apply to vehicles sold for certain commercial uses. See your retailer for full details.

1) This is a driver convenience system, not a substitute for active driver involvement. The driver must remain aware of his/her surroundings and be prepared to take corrective action to avoid collisions. 2) Driving while distracted can result in loss of vehicle control. Only use mobile phones and other devices, even with voice controls, when it is safe to do so. Apple CarPlay requires a compatible iPhone connected via USB cable to the Uconnect system. Android Auto requires the Android Auto App on Google Play and an Android compatible smartphone running Android 5.0 or higher. Data plan rates may apply. 3) Requires SiriusXM radio subscriptions governed by SIRIUS terms and conditions available at siriusxm.ca. 4) All SiriusXM Guardian equipped vehicles come with a 12-month trial effective on the date of purchase or lease of a new vehicle. Enrollment in the trial is required to receive service. Upon expiration of the trial period, purchase of a subscription is required to continue SiriusXM Guardian. Services can only be used where cellular coverage is available. See Uconnect and SiriusXM Guardian Terms of Service for complete service limitations. 5) SiriusXM Traffic and SiriusXM Travel Link require a subscription, sold separately or as a package, by SiriusXM Radio Inc. If you decide to continue service after your trial period included with the new vehicle purchase, the subscription plan you choose will automatically renew thereafter and you will be charged according to your chosen payment method at then-current rates. Trial service is not transferable. Fees and taxes apply. Please see the customer Agreement at www.siriusxm.ca for complete terms and how to cancel, which includes calling SiriusXM at 1-866-539-7474. All fees and programming are subject to change. Not all vehicles or devices are capable of receiving all services offered by SiriusXM. Data displays and individual product availability vary by vehicle hardware. Current information and features may not be available in all locations, or on all receivers. Weather Forecast, Current Conditions may not be available in all locations. 6) Only available with automatic transmissions. 7) No system can repeal the laws of physics or overcome careless driving actions. Performance is limited by available traction, which snow, ice and other conditions can affect. When the warning lamp flashes, the driver needs to use less throttle and adapt speed and driving behaviour to prevailing road conditions. 8) The Advanced Front Air Bags in this vehicle are certified to the Federal regulations for Advanced Air Bags. Children 12 years old and younger should always ride buckled up in a rear seat. Infants in rear-facing child restraints should never ride in the front seat of a vehicle with a passenger front air bag. All occupants should always wear their lap and shoulder belts properly. 9) Never program while driving. GPS mapping and available 3D navigation may not be detailed or available in all areas or reflect current road regulations. 10) Preset voice-to-text messaging and incoming text message reading require a MAP-enabled phone. 11) Driving while distracted can result in loss of vehicle control. Only use mobile phones and other devices, even with voice commands, when it is safe to do so. Voice commands of phone require a Bluetooth compatible phone. 12) Three-month/1GB trial included with the purchase or lease of a new vehicle. Upon expiration of the trial period, purchase of a subscription is required. Wi-Fi Hotspot available through third-party subscription. Requires internet-enabled mobile device. See retailer for details. This feature is not intended for use by the driver while the vehicle is in motion. Always drive carefully. 13) In the event of a medical or other emergency, press the SOS button to be connected to a Customer Care agent who can direct emergency assistance to your vehicle's location. 14) Roadside Assistance call provides direct calling to Roadside Assistance Service. Vehicle must be within the United States Puerto Rico or Canada and have network coverage. Additional roadside assistance charges may apply. Check warranty for details. 15) When equipped with remote start. 16) Theft Alarm Notification is compatible with factory-installed alarms only. 17) Do not attempt water fording unless depth is known to be less than 76 cm (30 in). Traversing water can cause damage that may not be covered by the new vehicle warranty. Always off-road responsibly in approved areas. 18) Based on IHSMarkit Automotive Canadian New Vehicle Total Registrations for combined years 2015 to CTD August 2018. 19) Be sure to follow all instructions in the Owner's Manual for removal of top and doors and lowering of windshield. Driving with doors off and windshield down is for off-road use only. 20) Not compatible with all garage door openers. 21) Stolen vehicle police report required. Always notify law enforcement if your vehicle is stolen and do not attempt to recover it on your own.

This brochure is a publication of FCA Canada Inc. All product illustrations and specifications are based upon current competitive information at the time of publication approval. FCA Canada Inc. reserves the right to make changes from time to time, without notice or obligation, in prices, specifications, colours and materials, and to change or discontinue models which are considered necessary to the purpose of product improvement or for reasons of design and/or marketing.

JEEP.CA

Wrangler Catalogue #52020C578E
DEALER ePROCESS

Jeep